



# Application manual

## DeviceNet

Robot controller  
RobotWare 5.0



Application manual

DeviceNet

RobotWare 5.0

Document ID: 3HAC020676-001

Revision: B

The information in this manual is subject to change without notice and should not be construed as a commitment by ABB. ABB assumes no responsibility for any errors that may appear in this manual.

Except as may be expressly stated anywhere in this manual, nothing herein shall be construed as any kind of guarantee or warranty by ABB for losses, damages to persons or property, fitness for a specific purpose or the like.

In no event shall ABB be liable for incidental or consequential damages arising from use of this manual and products described herein.

This manual and parts thereof must not be reproduced or copied without ABB's written permission, and contents thereof must not be imparted to a third party nor be used for any unauthorized purpose. Contravention will be prosecuted.

Additional copies of this manual may be obtained from ABB at its then current charge.

© Copyright 2004 ABB All right reserved.

ABB Automation Technologies AB  
Robotics  
SE-721 68 Västerås  
Sweden

|   |           |
|---|-----------|
| Overview .....  | 5         |
| Product documentation, M2004 .....                              | 8         |
| Safety .....  | 10        |
| <b>1 Reference information, DeviceNet .....</b>                 | <b>11</b> |
| 1.1 Introduction .....  | 11        |
| 1.2 References .....  | 12        |
| <b>2 Overview .....</b>   | <b>13</b> |
| 2.1 DeviceNet, general .....                                    | 13        |
| 2.2 DeviceNet, IRC5 .....                                       | 16        |
| 2.3 Definition of I/O units .....                               | 19        |
| <b>3 DeviceNet Master/Slave hardware.....</b>                   | <b>21</b> |
| <b>3.1 Hardware description .....</b>                           | <b>21</b> |
| 3.1.1 DSQC 603, DeviceNet Master/Slave .....                    | 21        |
| 3.1.2 Definition of communication units, IRC5 .....             | 24        |
| <b>3.2 Connections .....</b>                                    | <b>26</b> |
| 3.2.1 Shield grounding .....                                    | 26        |
| 3.2.2 Connection of the DeviceNet bus, IRC5 .....               | 27        |
| 3.2.3 Selecting cables .....                                    | 30        |
| 3.2.4 Repeaters .....   | 33        |
| <b>4 DeviceNet Master/Slave configuration .....</b>             | <b>35</b> |
| 4.1 Introduction .....  | 35        |
| <b>4.2 Overview .....</b>                                       | <b>36</b> |
| 4.2.1 DeviceNet master .....                                    | 36        |
| 4.2.2 DeviceNet internal slave .....                            | 39        |
| <b>4.3 Workflows .....</b>                                      | <b>40</b> |
| 4.3.1 Configuration of third part units.....                    | 40        |
| 4.3.2 Working with IRC5 internal DeviceNet slave .....          | 42        |
| 4.3.3 DeviceNet communication between two IRC5 controllers..... | 45        |
| <b>4.4 Parameters .....</b>                                     | <b>47</b> |
| 4.4.1 System parameters.....                                    | 47        |
| <b>5 Boards and units .....</b>                                 | <b>55</b> |
| <b>5.1 General.....</b>   | <b>55</b> |
| 5.1.1 DeviceNet Bus and I/O board status LED description.....   | 55        |
| 5.1.2 DeviceNet Bus status LEDs at power-up.....                | 58        |



## Table of Contents

---

|   |           |
|---|-----------|
| 5.1.3 External I/O units .....                                    | 59        |
| 5.1.4 Coil neutralization .....                                   | 60        |
| 5.1.5 Setting DeviceNet bus ID .....                              | 62        |
| <b>5.2 Unit descriptions .....</b>                                | <b>64</b> |
| 5.2.1 Introduction .....  | 64        |
| 5.2.2 DSQC 327A, AD combi I/O .....                               | 65        |
| 5.2.3 DSQC 328A, Digital I/O .....                                | 74        |
| 5.2.4 DSQC 332A, Digital I/O with relay outputs .....             | 81        |
| 5.2.5 DSQC 355A, Analog I/O .....                                 | 90        |
| 5.2.6 DSQC 350A, DeviceNet/Allen Bradley remote I/O gateway ..... | 100       |
| 5.2.7 DSQC 351A, DeviceNet/INTERBUS gateway .....                 | 109       |
| 5.2.8 DSQC 352A, DeviceNet/PROFIBUS-DP gateway .....              | 119       |
| 5.2.9 DSQC 378A, DeviceNet/CCLink gateway .....                   | 128       |
| 5.2.10 DSQC 377A, Queue tracking unit.....                        | 139       |

## Overview

---

### About this manual

This manual describes the DeviceNet option and contains instructions for the DeviceNet Master/Slave configuration. It also describes the configuration of boards and units.

---

### Usage

This manual should be used during installation and configuration of the DeviceNet bus and upgrading of the DeviceNet option.

---

### Who should read this manual?

This manual is intended for

- personnel that are responsible for installations and configurations of fieldbus hardware/software
- personnel that make the configurations of the I/O system
- system integrators

---

### Prerequisites

The reader should have the required knowledge of

- mechanical installation work
- electrical installation work

*Continues on next page*

---

## Organization of chapters

The manual is organized in the following chapters:

| Chapter | Contents   |
|---------|--|
| 1       | This chapter gives reference information, both to external documentation and other ABB manuals.  |
| 2       | This chapter gives an overview of the DeviceNet fieldbus and includes following: <ul style="list-style-type: none"><li>• a general description of DeviceNet and the communication protocol connections</li><li>• description of how the DeviceNet master/slave unit and I/O units are connected in a robot system</li><li>• definition of I/O units in the IRC5 controller and the configuration of the controller</li></ul> |
| 3       | This chapter describes the DSQC 603 Master/Slave board. The chapter also describes <ul style="list-style-type: none"><li>• communication units</li><li>• how to connect the DeviceNet master to an I/O unit</li><li>• termination</li><li>• cable types and data rates</li><li>• repeater functions</li></ul>  |
| 4       | This chapter gives an overview of the DeviceNet master and internal slave configuration. The chapter contains descriptions of workflows and system parameters.   |
| 5       | This chapter gives detailed descriptions of I/O units and gateways that support DeviceNet communication. The chapter also describes <ul style="list-style-type: none"><li>• DeviceNet bus status LEDs at power-up</li><li>• how to set the DeviceNet bus ID</li></ul>  |

*Continues on next page*

---

## Revisions

| Revision | Description  |
|----------|--|
| -        | First edition  |
| A        | <p>The following corrections are made in chapter <b>5 Boards and units</b>:</p> <ul style="list-style-type: none"><li>• A completing in section <i>General</i>.</li><li>• A correction in the description of the numerical format for the DSQC 355A unit, in section <i>Unit descriptions</i>.</li></ul>   |
| B        | <p>The following updates are made in chapter <b>2 Overview</b>:</p> <ul style="list-style-type: none"><li>• Section <i>DeviceNet, general</i>; the different types of I/O connections are described more in detail.</li><li>• Section <i>DeviceNet, IRC5</i>; the figure illustrating the hardware overview is updated.</li></ul> <p>The following updates are made in chapter <b>4 DeviceNet Master/Slave configuration</b>:</p> <ul style="list-style-type: none"><li>• Section <i>Working with IRC5 internal DeviceNet slave</i>; the illustration is updated.</li><li>• Section <i>DeviceNet communication between two IRC5 controllers</i>; the illustration is updated.</li></ul> <p>The following updates are made in chapter <b>5 Boards and units</b>:</p> <ul style="list-style-type: none"><li>• Section <i>Unit descriptions</i>; the article numbers for the respective units are completed in the overview table of the I/O units, each I/O unit description includes information about which types of I/O connections they support.</li><li>• Section <i>DSQC 332A, Digital I/O with relay outputs</i>; illustrations of how to connect the digital outputs and digital inputs.</li></ul> |

## Product documentation, M2004

---

### General

The robot documentation may be divided into a number of categories. This listing is based on the type of information contained within the documents, regardless of whether the products are standard or optional. This means that any given delivery of robot products *will not contain all* documents listed, only the ones pertaining to the equipment delivered.

However, all documents listed may be ordered from ABB. The documents listed are valid for M2004 robot systems.

---

### Hardware manuals

All hardware, robots and controller cabinets, will be delivered with a **Product manual** which is divided into two parts:

#### **Product manual, procedures**

- Safety information
- Installation and commissioning (descriptions of mechanical installation, electrical connections and loading system software)
- Maintenance (descriptions of all required preventive maintenance procedures including intervals)
- Repair (descriptions of all recommended repair procedures including spare parts)
- Additional procedures, if any (calibration, decommissioning)

#### **Product manual, reference information**

- Reference information (article numbers for documentation referred to in Product manual, procedures, lists of tools, safety standards)
- Part list
- Foldouts or exploded views
- Circuit diagrams

*Continues on next page*

---

## RobotWare manuals

The following manuals describe the robot software in general and contain relevant reference information:

- **RAPID Overview:** An overview of the RAPID programming language.
- **RAPID reference manual part 1:** Description of all RAPID instructions.
- **RAPID reference manual part 2:** Description of all RAPID functions and data types.
- **Technical reference manual - System parameters:** Description of system parameters and configuration workflows.

---

## Application manuals

Specific applications (e.g. software or hardware options) are described in **Application manuals**. An application manual can describe one or several applications.

An application manual generally contains information about:

- The purpose of the application (what it does and when it is useful)
- What is included (e.g. cables, I/O boards, RAPID instructions, system parameters)
- How to use the application
- Examples of how to use the application

---

## Operator's manuals

This group of manuals is aimed at those having first hand operational contact with the robot, i.e. production cell operators, programmers and trouble shooters. The group of manuals include:

- **Getting started - IRC5 and RobotStudio Online**
- **Operator's manual - IRC5 with FlexPendant**
- **Operator's manual - RobotStudio Online**
- **Trouble shooting manual** for the controller and robot

## Safety

---

### Safety of personnel

When working inside the controller it is necessary to be aware of voltage related risks.

A danger of high voltage is associated with the following parts:

- Units inside the controller, for example I/O units can be supplied with power from an external source.
- The mains supply/mains switch.
- The power unit.
- The power supply unit for the computer system (230 VAC).
- The rectifier unit (400-480 VAC and 700 VDC). Capacitors!
- The drive unit (700 VDC).
- The service outlets (115/230 VAC).
- The power supply unit for tools, or special power supply units for the machining process.
- The external voltage connected to the controller remains live even when the robot is disconnected from the mains.
- Additional connections.

Therefore, it is important that all safety regulations are followed when doing mechanical and electrical installation work.

---

### Safety regulations

Before beginning mechanical and/or electrical installations, make sure you are familiar with the safety regulations described in *Product manual IRC5, M2004*.

# 1 Reference information, DeviceNet

## 1.1. Introduction

---

### General

This chapter includes general information, complementing the more specific information in the following chapters.



# 1 Reference information, DeviceNet

---

## 1.2. References

### 1.2. References

---

#### Document references

| References   | Document ID    |
|--|----------------|
| Application manual - Conveyor tracking                   | 3HAC16587-1    |
| Application manual - Motion coordination and supervision | 3HAC 18154-1   |
| Application manual - Robot communication and I/O control | 3HAC020435-001 |
| Operator's manual - IRC5 with FlexPendant                | 3HAC 16590-1   |
| Operator's manual - RobotStudio <sup>Online</sup>        | 3HAC 18236-1   |
| Product manual IRC5, M2004                               | 3HAC021313-001 |
| Product specification, IRC5 with FlexPendant             | 3HAC021785-001 |
| Technical reference manual - System parameters           | 3HAC 17076-1   |

#### Other references

| References                                     | Description   |
|--|---|
| <a href="http://www.odva.org">www.odva.org</a> | The web site of ODVA (Open DeviceNet Vendor Association).     |
| ODVA DeviceNet Specification, revision 2.0     | Specification from ODVA (Open DeviceNet Vendor Associations). |

## 2 Overview

### 2.1. DeviceNet, general

---

#### What is DeviceNet?

DeviceNet is a communications link to connect industrial devices. It is a simple networking solution that reduces both cost and time to wire and install industrial automation devices, and the direct connectivity provides improved communication between devices. DeviceNet is an open network standard.

Here are some examples of applications:

- peer-to-peer data exchange where a DeviceNet product can produce and consume messages
- master/slave operation defined as a proper subset of Peer-to-Peer
- a DeviceNet product can function as a client or server, or both

---

#### DeviceNet specification

The DeviceNet specification defines a network communication system for moving data between elements of an industrial control system.

*Continues on next page*

## 2 Overview

---

### 2.1. DeviceNet, general

*Continued*

---

#### Communication protocol connections

The user must establish a connection with a device in order to exchange information with that device.

DeviceNet defines following two different types of messaging:

| Type of message   | Description  |
|-------------------|--|
| Explicit messages | Explicit messages provide multi-purpose and point-to-point communication paths between two devices. Explicit messages provide the typical request/response oriented network communications used to perform node configuration and problem diagnosis. |
| I/O messages      | I/O messages are for time-critical and control-oriented data, and they provide a dedicated and special-purpose communication path between a producing application and one or more consuming applications.  |

*Continues on next page*

#### I/O messages - connection types

The following table describes the different types of I/O connections.

| Type of I/O connection                       | Description   |
|--|---|
| Polled connection                            | This technique is used for any amount of I/O data. Each slave receives a query from the master and may or may not respond before the next device has received a query. A slave can only respond to a request from the master.   |
| Strobe connection                            | A single multicasting request. Quick exchange of a small amount of I/O data between a master and its slaves. The master sends one message that contains one bit of output data to each slave that has a strobe connection. This will result in a synchronized reading of data.  |
| Change-Of-State (COS) connection             | Units are configured to produce data upon a change of I/O data. This technique can improve system throughput significantly. Data messages must be acknowledged by the receiver before new messages can be sent. Heart beat messages are used to tell the receiver that the unit is still alive even if no data has changed state for a long time. |
| Cyclic connection                            | Units are configured to produce data on a pre-configured time interval. Data production messages must be acknowledged before a new message can be sent.   |
| Change-Of-State with acknowledge suppression | Units are configured to produce data upon a change of application data. This technique can improve system throughput significantly. No acknowledge is required, that is the receiver of data must be able to consume the data at the same rate as it is produced by the sending unit.   |
| Cyclic with acknowledge suppression          | Units are configured to produce data on a pre-configured time interval. No acknowledge is required, that is the receiver of data must be able to consume the data at the same rate as it is produced by the sending unit.   |

## 2 Overview

---

### 2.2. DeviceNet, IRC5

## 2.2. DeviceNet, IRC5

---

### Hardware overview

The hardware of the DeviceNet fieldbus consists of a Master/Slave unit, DSQC 603, and distributed I/O units (called Slave units). The DSQC 603 unit is located in the computer unit in the control module of the IRC5 controller where it is connected to the PCI backplane.

The slave part of the DSQC 603 unit is normally controlled by an external master on the same physical DeviceNet network. It is possible to act as a master and a slave simultaneously.

### Slave units

The slave units are attached to the fieldbus network, and can be any DeviceNet compliant device. They are controlled via the master part of the DSQC 603 unit.

*Continues on next page*

#### Illustration

The following illustration shows an overview of the hardware.

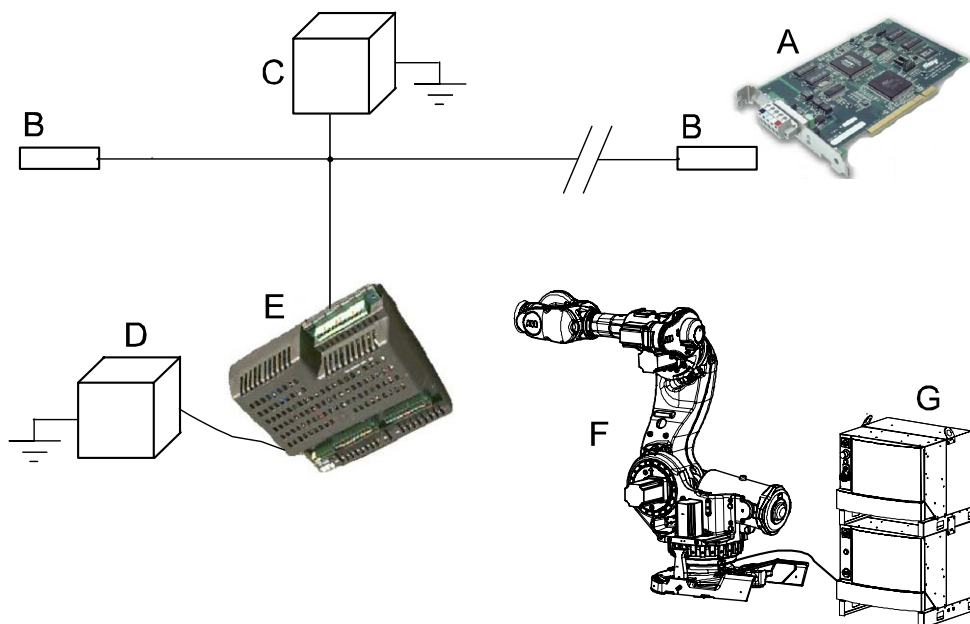

xx030000531

|   |  |
|---|--|
| A | DSQC 603, DeviceNet fieldbus   |
| B | Terminating resistor (121 Ohm). The maximum length of the trunk cable is 100 m.  |
| C | DSQC 608 or DSQC 634, DeviceNet power supply 24 V                                |
| D | DSQC 608, Customer power supply 24 V   |
| E | DSQC 328A, Distributed digital I/O. The maximum length of the drop cable is 6 m. |
| F | Robot  |
| G | IRC5 controller  |

*Continues on next page*

## 2 Overview

---

### 2.2. DeviceNet, IRC5

*Continued*

#### Additional slave

When there is a need of an additional slave and running different baudrates, it is possible to have two DSQC 603 boards in the same IRC5 system. They will work independently from each other and have the same possibilities and constrains as described in this document.

#### Bus configuration

Configuration of the bus is done using RobotStudio<sup>Online</sup>.

---

### Specification overview

| Item   | Specification   |
|--|---|
| Fieldbus type                                      | DeviceNet   |
| Specification revision                             | DeviceNet specification release 2.0   |
| Data rate  | 125, 250, 500 kbps  |
| Support for Predefined Master/Slave connection set | Group 2 Client (Master)<br>Group 2 Only Client (Master)<br>Group 2 Server (Slave) |

### 2.3. Definition of I/O units

#### General

The controller may be mounted with I/O units inside the control module.

#### Standard configuration

In the standard form, no fieldbus is mounted to the controller. However, digital inputs and outputs are available on the customer plate in the control module.

It is possible to connect any type of DeviceNet compliant I/O unit on the DeviceNet - DSQC 603 - master bus. All I/O units should comply with the DeviceNet standard and be conformance tested by ODVA.

#### Configuration of the controller

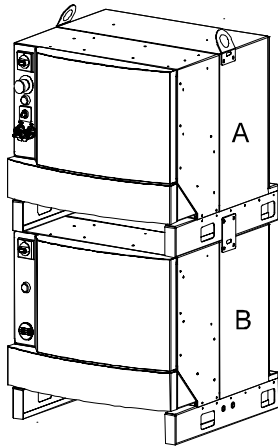

xx040000846

|   |                |
|---|----------------|
| A | Control module |
| B | Drive module   |

*Continues on next page*



## 2 Overview

---

### 2.3. Definition of I/O units

*Continued*

---

#### Further information

The table gives references to additional information:

| <b>Information:</b>   | <b>Found in:</b>   |
|---|--|
| Detailed descriptions of all available I/O units and gateways that support DeviceNet communication: | Section <a href="#">Introduction on page 64</a> .  |
| How to install the I/O units and gateways mechanically and electrically:                            | <a href="#">Product manual IRC5, M2004</a> , section <a href="#">Replacement of I/O units and gateways, IRC5</a> . |
| Allowed configurations of I/O units and how to setup the configurations:                            | <a href="#">Technical reference manual - System parameters</a>   |
| How to install the software of the I/O units and gateways related in a new system:                  | <a href="#">Product manual IRC5, M2004</a>   |

## 3 DeviceNet Master/Slave hardware

### 3.1 Hardware description

#### 3.1.1. DSQC 603, DeviceNet Master/Slave

##### Description

The DSQC 603 is a circuit board mounted in the computer module. The unit can be operated both as a master and a slave (at the same time) for a DeviceNet system.

For installation descriptions of the DeviceNet scanner board refer to *Product manual IRC5, M2004*, section *Replacement of PCI cards in the Computer unit slots, IRC5*.

##### Illustration

The figure below shows the DSQC 603 board:

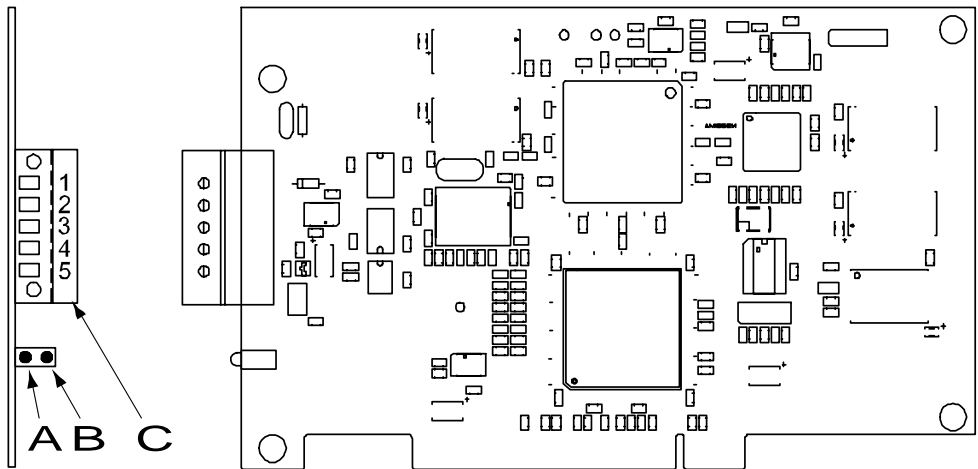

xx0200000291

|   |                     |
|---|---------------------|
| A | LED Comm            |
| B | LED Health          |
| C | DeviceNet connector |

*Continues on next page*

## 3 DeviceNet Master/Slave hardware

### 3.1.1. DSQC 603, DeviceNet Master/Slave

*Continued*

---

#### DeviceNet connector

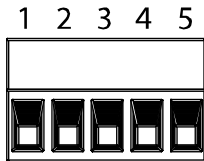

xx0200000292

The table below shows the connections to DeviceNet connector:

| Signal name | I/O pin | Wire color | Function                                   |
|-------------|---------|------------|--|
| V-          | 1       | black      | DeviceNet network negative power (0 V)     |
| CANL        | 2       | blue       | DeviceNet communication bus terminal       |
| Shield      | 3       | bare       | Network cable shield                       |
| CANH        | 4       | white      | DeviceNet communication bus terminal       |
| V+          | 5       | red        | DeviceNet network positive power (24 V DC) |

---

#### LEDs

| Designation | Color status   | Description  |
|-------------|----------------|--|
| Comm        | Off            | Offline, i.e. board is not communicating on the network.   |
| Comm        | Flashing green | Online, i.e. board is communicating on the network but no configured devices are found.                        |
| Comm        | Solid green    | Online and configured, i.e. board is communicating on the network and at least one configured device is found. |
| Comm        | Solid red      | Bus off, i.e. board unable to communicate on network.  |
| Health      | Off            | No power supply to PCI bus.  |

*Continues on next page*

### 3 DeviceNet Master/Slave hardware

---

#### 3.1.1. DSQC 603, DeviceNet Master/Slave

*Continued*

| Designation | Color status | Description   |
|-------------|--------------|---|
| Health      | Solid green  | Board is running. Start-up self test OK.  |
| Health      | Solid red    | Board is not running, an error occurred during board firmware load or a fatal runtime error occurred.<br><b>NOTE!</b> This LED should be lit red at start-up until the proper software is loaded. |

## 3 DeviceNet Master/Slave hardware

### 3.1.2. Definition of communication units, IRC5

### 3.1.2. Definition of communication units, IRC5

#### General

The IRC5 computer unit may include a number of communication functions. Any allowed combination of these is specified below.

#### Board definition

The figure and table below specify which combinations are allowed:

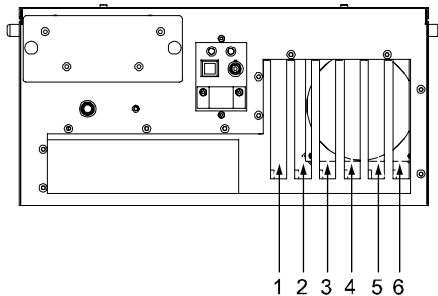

xx0400000847

| Description                             | Art. no.        | Note   | Pos.         |
|---|-----------------|--|--------------|
| Robot Com. Card                         | 3HAC 12816-1    | DSQC 602<br>Always mounted in slot 1 as shown in the figure above!   | 1            |
| Ethernet card                           | 3HAC 15639-1    | DSQC 612<br>Only used in MultiMove control applications.   | 2, 3, 4 or 5 |
| DeviceNet master/slave                  | 3HAC 12817-1    | DSQC 603   | 2, 3, 4 or 5 |
| PROFIBUS DP master/slave                | 3HAC 023047-001 | DSQC 637   | 2, 3, 4 or 5 |
| INTERBUS master/slave, copper interface | 3HAC 11819-1    | DSQC 529<br>Two physical boards, i.e. the master board and the slave board are placed in two separate slots. | 2, 3, 4 or 5 |

*Continues on next page*

## 3 DeviceNet Master/Slave hardware

### 3.1.2. Definition of communication units, IRC5

*Continued*

| Description   | Art. no.    | Note   | Pos.            |
|---|-------------|--|-----------------|
| INTERBUS master/<br>slave, fiber optical<br>interface | 3HAC 5579-1 | DSQC 512<br>Two physical boards, i.e. the<br>master board and the slave board<br>are placed in two separate slots. | 2, 3, 4 or<br>5 |
| -   | -           | Not used   | 6               |

#### Installation of communication units

For installation descriptions refer to *Product manual IRC5, M2004*, section *Replacement of PCI cards in the Computer unit slots, IRC5*.

## 3 DeviceNet Master/Slave hardware

---

### 3.2.1. Shield grounding

## 3.2 Connections

### 3.2.1. Shield grounding

---

#### General

The DeviceNet shield and V- should be interconnected and grounded at only one place in the DeviceNet network. For more advanced connections with several power supplies refer to the *DeviceNet Specification*, see *References on page 12*.

---

#### Grounding

The illustration below shows an example of cable grounding.

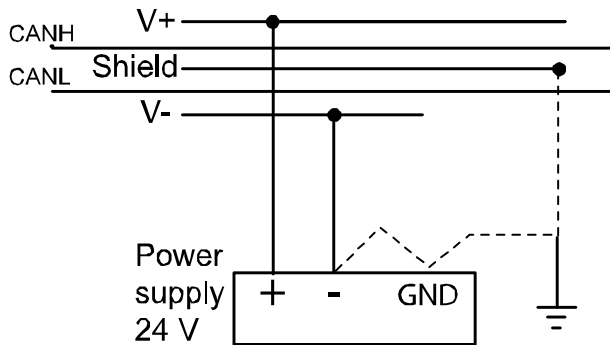

xx0300000525

### 3.2.2. Connection of the DeviceNet bus, IRC5

#### Illustration

The illustration below shows an example of how to connect the DeviceNet bus.

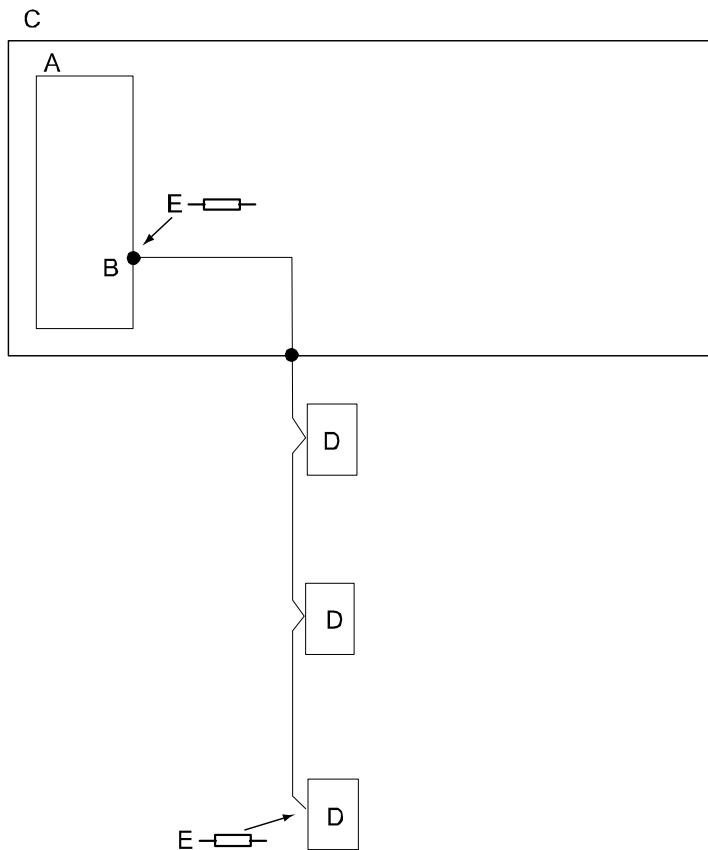

xx0300000615

|   |  |
|---|--|
| A | DeviceNet PCI board                      |
| B | DeviceNet connector                      |
| C | Computer unit                            |
| D | I/O unit                                 |
| E | 121 ohm, 1 %, 0.25 W metal film resistor |

*Continues on next page*



### 3 DeviceNet Master/Slave hardware

---

#### 3.2.2. Connection of the DeviceNet bus, IRC5

*Continued*

---

#### Physical connection between DeviceNet bus and DeviceNet node

Following figure shows how next DeviceNet node is connected to the DeviceNet master.

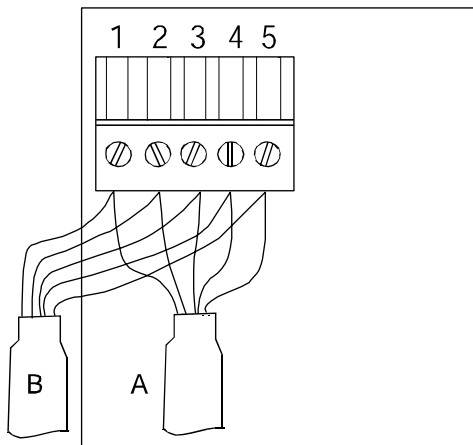

xx040000849

|   |                                   |
|---|-----------------------------------|
| A | DeviceNet master                  |
| B | DeviceNet node, i.e. an I/O unit. |

*Continues on next page*

#### Termination resistors in DeviceNet bus

Each end of the DeviceNet bus must be terminated with a 121 ohm resistor. The two terminating resistors should be as far apart as possible.

The termination resistor is placed in the cable connector. There is no internal termination on the DeviceNet PCI board. The termination resistor is connected between CANL and CANH, that is between pin 2 and pin 4 according to the illustration below. See also [Illustration on page 27](#).

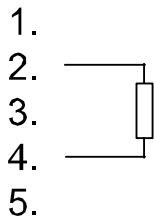

xx0400000674

|   |        |
|---|--------|
| 1 | V-     |
| 2 | CANL   |
| 3 | Shield |
| 4 | CANH   |
| 5 | V+     |

## 3 DeviceNet Master/Slave hardware

---

### 3.2.3. Selecting cables

#### 3.2.3. Selecting cables

---

##### DeviceNet bus

The end-to-end network distance varies with data rate and cable thickness. For information about cable length depending on cable type and data rate, see tables below.

For specification of the designations on the different cable types, see *ODVA DeviceNet Specification*.

Data rate 500 kbit/s

| Cable type             | Max. length       |
|------------------------|-------------------|
| Thick trunk length     | 100 m<br>(328 ft) |
| Thin trunk length      | 100 m<br>(328 ft) |
| Flat trunk cable       | 75 m<br>(246 ft)  |
| Maximum drop length    | 6 m<br>(20 ft)    |
| Cumulative drop length | 39 m<br>(128 ft)  |

*Continues on next page*

*Continued*

Data rate 250 kbit/s

| <b>Cable type</b>      | <b>Max. length</b> |
|------------------------|--------------------|
| Thick trunk length     | 250 m<br>(820 ft)  |
| Thin trunk length      | 100 m<br>(328 ft)  |
| Flat trunk cable       | 200 m<br>(656 ft)  |
| Maximum drop length    | 6 m<br>(20 ft)     |
| Cumulative drop length | 78 m<br>(256 ft)   |

Data rate 125 kbit/s

| <b>Cable type</b>      | <b>Max. length</b>  |
|------------------------|---------------------|
| Thick trunk length     | 500 m<br>(1,640 ft) |
| Thin trunk length      | 100 m<br>(328 ft)   |
| Flat trunk cable       | 380 m<br>(1,250 ft) |
| Maximum drop length    | 6 m<br>(20 ft)      |
| Cumulative drop length | 156 m<br>(512 ft)   |

*Continues on next page*

### 3 DeviceNet Master/Slave hardware

#### 3.2.3. Selecting cables

*Continued*

#### Illustration of trunk line and drop lines

The figure below illustrates a trunk line with drop lines. Thick or thin cable can be used for either trunk lines or drop lines, for information about cable thickness and data rate see the tables above.

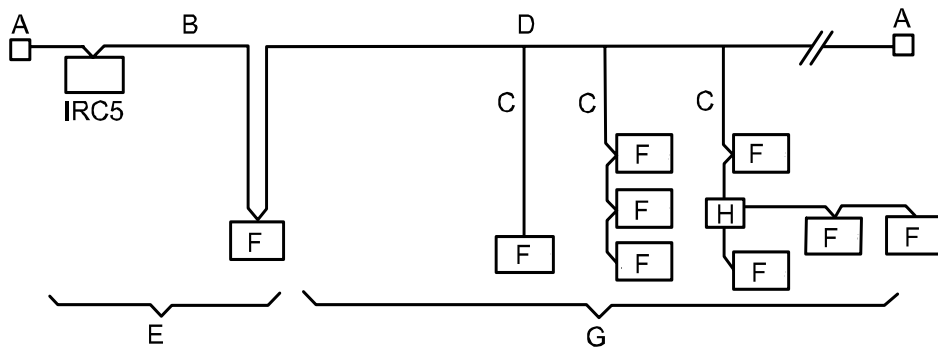

xx0300000579

|   |             |
|---|-------------|
| A | Terminator  |
| B | Trunk line  |
| C | Drop line   |
| D | Tap         |
| E | Zero drop   |
| F | Node        |
| G | Short drop  |
| H | T-connector |

### 3.2.4. Repeaters

#### Usage

Repeaters are used for the following purposes:

- To avoid disturbances such as ESD/EFT, which may otherwise propagate to other parts of the network.
- To isolate noisy segments.
- When using several power supplies a repeater could be used to isolate the supplies from each other to avoid voltage potential differences and ground currents.

#### Extending the length of a trunk line

The figure illustrates an application example where a repeater is used for extending the length of a trunk line.

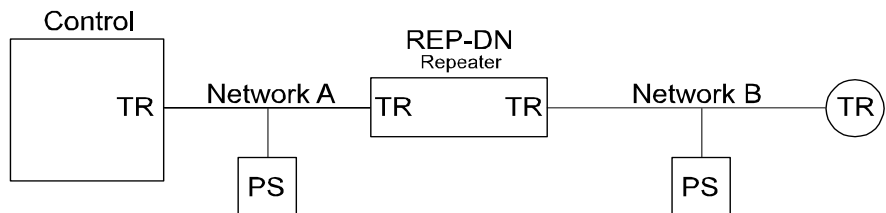

en0400000724

|         |                      |
|---------|----------------------|
| Control | Controller           |
| TR      | Terminating resistor |
| PS      | Power supply         |

*Continues on next page*

### 3 DeviceNet Master/Slave hardware

#### 3.2.4. Repeaters

*Continued*

#### Extending the length of a drop line

Following figure illustrates an application example where a repeater is used for extending the length of a drop line.

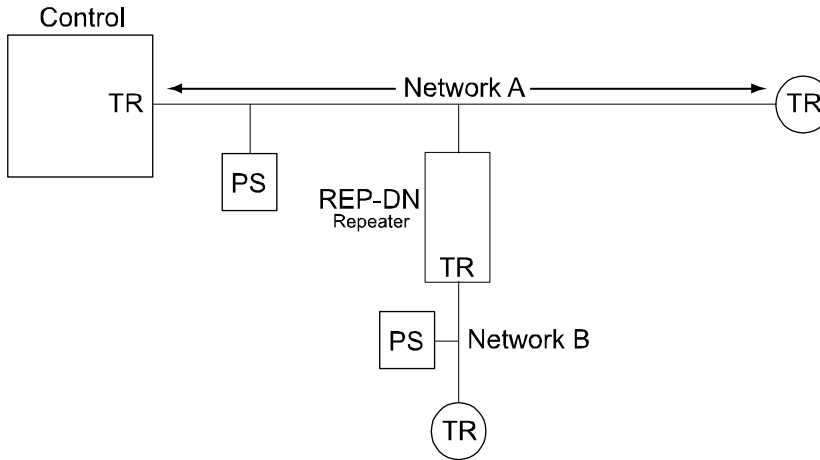

en0400000725

|         |                      |
|---------|----------------------|
| Control | Controllert          |
| TR      | Terminating resistor |
| PS      | Power supply         |

# 4 DeviceNet Master/Slave configuration

## 4.1. Introduction

---

### Controller software

The IRC5 controller must be installed with software that supports the use of the DeviceNet network, that is the option for DeviceNet must be installed.

For description of how to add the DeviceNet option, see *Adding RobotWare option* in *Operator's manual - RobotStudio Online*.

---

### PC software

RobotStudio<sup>Online</sup> is PC software that is used to set up connections to robots and to work with robots.

The configuration for the DeviceNet communication is done either manually by RobotStudio<sup>Online</sup>, or by loading a configuration file from RobotStudio<sup>Online</sup>. For information on how to work with RobotStudio<sup>Online</sup> refer to *Operator's Manual - RobotStudio<sup>Online</sup>*, see *References on page 12*.



## 4 DeviceNet Master/Slave configuration

---

### 4.2.1. DeviceNet master

## 4.2 Overview

### 4.2.1. DeviceNet master

---

#### Configuration

The maximum number of I/O units that can be defined in the IRC5 system is described in *Technical reference manual - System parameters*, see *References on page 12*. DeviceNet itself has an addressing range from 0-63 and a possibility to have 63 devices on the same network.

Counted as I/O units are

- all DeviceNet slave units connected to the IRC5 DeviceNet master
- the internal DeviceNet slave (at DSQC 603)
- simulated I/O units and other I/O units connected to other IRC5 fieldbuses.

No difference is made between ABB I/O units and units from other vendors. There is no additional software option, with the exception of the DeviceNet option, that is required to run I/O units from other vendors.

*Continues on next page*

Following table gives descriptions of defining the DeviceNet Bus, the DeviceNet Unit Type and the DeviceNet Unit.

| Defining...         | Description  |
|---------------------|--|
| DeviceNet Bus       | <p>A DeviceNet bus must be defined before any communication on the bus is possible, i.e. define rules for the DSQC 603 DeviceNet master to communicate on the network.</p> <p>Following two system parameters are DeviceNet specific:</p> <ul style="list-style-type: none"><li>• <i>DeviceNet Master Address</i> defines the address which the DSQC 603 DeviceNet master should use.</li><li>• <i>DeviceNet Communication Speed</i> defines the communication speed (baudrate).</li></ul>   |
| DeviceNet Unit Type | <p>When creating a unit type some system parameters are fieldbus specific. For detailed information about the parameters see <a href="#">Technical reference manual - System parameters</a>.</p> <p>The correct values are normally found in the EDS file (Electronic Data Sheet) for the unit. The EDS file should be obtained from the vendor of the I/O module. If an EDS file is unavailable, the generic unit type could be used to obtain necessary information about the unit, see <a href="#">DeviceNet generic unit type</a> in this section.</p> |
| DeviceNet Unit      | <p>The only DeviceNet specific system parameter in the unit definition is the unit address. For information see <a href="#">Technical reference manual - System parameters</a>.</p>  |

---

### DeviceNet generic unit type

To define a unit with the predefined unit type DN\_GENERIC, you only need to know the network address of the device to be able to communicate with it.

When the unit is connected, messages containing the information necessary to create a unit type will be displayed.

Following information is displayed:

- unit identification system parameters (Vendor id, Device type and Product code)
- the first connection system parameters of the unit (Connection 1 type, Connection 1 input size and Connection 1 output size).

*Continues on next page*

## 4 DeviceNet Master/Slave configuration

---

### 4.2.1. DeviceNet master

*Continued*

Other system parameters in the unit type can be left to their default values. See [Configuration of third part units on page 40](#).

**Note!** DN\_GENERIC should only be used when installing and commissioning new devices, it will increase the startup time. The identification of the I/O unit will be lost and there will not be any information if the unit is replaced with another unit, which has other functionality or size, when restarting the system.

---

### Explicit messaging services

It is possible to configure I/O units through explicit messaging services. This could either be done at startup by defining **Fieldbus Commands** to the configured unit, or at runtime from RAPID through the Fieldbus Command Interface (FCI). For information refer to *RAPID reference manual* and section "Fieldbus Command Interface" in the *Application manual - Robot Communication and I/O control*, see [References on page 12](#).

For explicit messaging at startup:

1. In the configuration define a "fieldbus command type" that is general to the unit type and could be used by many DeviceNet units of this unit type.
2. In the configuration define a "fieldbus command" that is specific to a certain unit and that specifies unit specific data to be sent to the unit. The "fieldbus command" is linked to a certain unit. The data defined in the value parameter should fit the instance or attribute size on the DeviceNet unit.

DeviceNet specific system parameters in the Fieldbus Command type are:

- Path
- Service

## 4.2.2. DeviceNet internal slave

---

### Configuration

The internal DeviceNet slave share address and physical connector with the master, and is configured as an ordinary I/O unit. A predefined unit type for the internal slave (DN\_SLAVE) is defined supporting a polled connection with the size of 8 input bytes and 8 output bytes of digital, analog or group signal data, as defined in the signal configuration for the slave.

---

### Electronic Data Sheet file

An EDS-file (Electronic Data Sheet) for the DeviceNet scanner board, matching the configuration with an internal slave of unit type DN\_SLAVE is located on the RobotWare release CD in the directory:

```
utility\fieldbus\DeviceNet\eds\
```

If another size or connection type on the internal slave is required a new slave unit type must be written and the EDS file must be changed to fit the new system parameters.

---

### I/O connection

One I/O connection is supported, but there is no explicit connection to the application. Size and connection type supported are defined in slave type Unit Type.

---

### Connecting two IRC5 systems

When connecting two IRC5 systems together the internal slave should be seen as and configured as any other slave from the other IRC5 system, see [Working with IRC5 internal DeviceNet slave on page 42](#).

The unit type DN\_SLAVE could be used both for the internal slave (configured with the same address as the master) and for connection to another IRC5 DeviceNet slave (configured with a different address than the master and the same address as the DeviceNet slave on the other IRC5 controller).

## 4 DeviceNet Master/Slave configuration

---

### 4.3.1. Configuration of third part units

## 4.3 Workflows

### 4.3.1. Configuration of third part units

---

#### Description of DeviceNet generic unit type

DN\_GENERIC is a predefined unit type that is used to set up a communication with any I/O unit in an easy way.

---

#### Usage

When new DeviceNet units should be configured and the information available is not sufficient to create a new unit type, then the generic unit type DN\_GENERIC could be used to retrieve necessary information. This could be the case when third part units should be configured.

---

#### Prerequisites

The network address of the I/O unit must be known and the baudrate must match the master.

---

#### Limitations

Only the simplest configuration will be configured.

**Note!** When using DN\_GENERIC you accept any type of unit as long as the address matches, i.e. you cannot ensure that you communicate with a special type of unit.

---

#### How to use the DeviceNet generic unit type

Following steps describe how to use the DeviceNet generic unit type:

| Step | Action   | Info/Illustration   |
|------|--|---|
| 1.   | Determine the address on the physical I/O unit.  |   |
| 2.   | Add unit at the determined address and with unit type DN_GENERIC.                            | For information see <a href="#">Operator's manual - RobotStudio<sup>Online</sup></a> .  |
| 3.   | Restart the system.  |   |
| 4.   | View event log that shows unit identification parameters and connection support information. | For information see <a href="#">Operator's manual - RobotStudio<sup>Online</sup></a> and/or <a href="#">Operator's manual - IRC5 with FlexPendant</a> . |

*Continues on next page*

## 4 DeviceNet Master/Slave configuration

---

### 4.3.1. Configuration of third part units

*Continued*

| Step | Action   | Info/Illustration  |
|------|--|--|
| 5.   | Create new unit type by using information from the event log, and change unit type from DN_GENERIC to the type just created. | For information see <a href="#">Operator's manual - RobotStudio<sup>Online</sup></a> .   |
| 6.   | Define the signals.  | For information see <a href="#">Operator's manual - RobotStudio<sup>Online</sup></a> and/or <a href="#">Technical reference manual - System parameters</a> . |
| 7.   | Restart the system.  |  |

## 4 DeviceNet Master/Slave configuration

---

### 4.3.2. Working with IRC5 internal DeviceNet slave

### 4.3.2. Working with IRC5 internal DeviceNet slave

---

#### Usage

When the IRC5 controller is connected to an external PLC for example, it should be configured as an internal DeviceNet slave. See *Illustration on page 43*.

---

#### Prerequisites

The network address of the I/O unit must be known.

---

#### Limitations

The internal DeviceNet slave has the following limitations:

- The internal slave, DN\_SLAVE, has the same address as the configured master.
- The default DN\_SLAVE supports 64 digital inputs and 64 digital outputs, but this number can be increased to the restriction in the I/O system (see Product Specification for IRC5 controller).

*Continues on next page*

## 4 DeviceNet Master/Slave configuration

### 4.3.2. Working with IRC5 internal DeviceNet slave

*Continued*

#### Illustration

The figure illustrates how to use the internal DeviceNet slave.

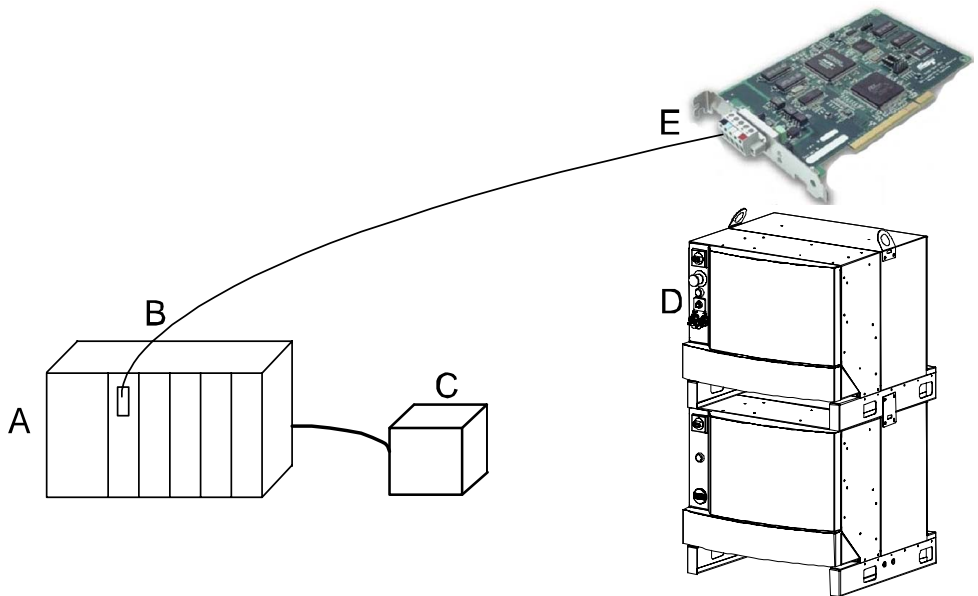

xx040000787

|   |                           |
|---|---------------------------|
| A | PLC                       |
| B | DeviceNet master          |
| C | Power supply unit, 24 VDC |
| D | IRC5 controller           |
| E | DeviceNet slave           |

*Continues on next page*



## 4 DeviceNet Master/Slave configuration

---

### 4.3.2. Working with IRC5 internal DeviceNet slave

*Continued*

---

#### How to use the internal DeviceNet slave

| Step | Action  | Info/Illustration  |
|------|---|--|
| 1.   | Add unit that have the same address as the master on the IRC5 DeviceNet PCI board, and with unit type DN_SLAVE. | For information see <a href="#">Operator's manual - RobotStudio<sup>Online</sup></a> . |
| 2.   | Define the signals on the created unit.   | For information see <a href="#">Operating manual - RobotStudio<sup>Online</sup></a> .  |
| 3.   | Restart the system. Now the IRC5 controller is ready to be contacted from another DeviceNet master.             |  |

## 4 DeviceNet Master/Slave configuration

### 4.3.3. DeviceNet communication between two IRC5 controllers

#### 4.3.3. DeviceNet communication between two IRC5 controllers

##### Description of the interconnection of two IRC5 controllers

When two IRC5 controllers are connected to each other via DeviceNet, one of them must be configured as a slave and the other one must be configured as a master. See illustration below.

##### Limitations

The master address cannot be the same on the two controllers since they shall be interconnected.

##### Illustration

The figure illustrates DeviceNet communication between two IRC5 controllers.

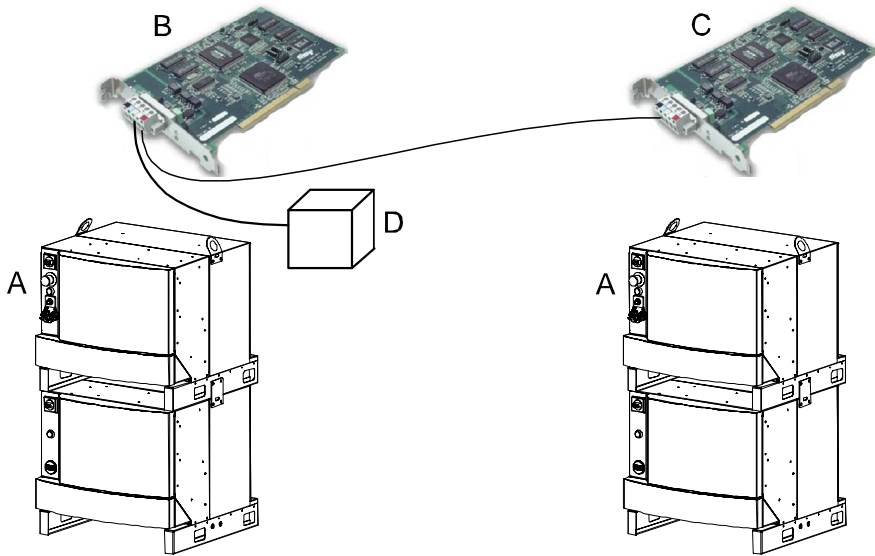

xx0400000788

|   |                           |
|---|---------------------------|
| A | IRC5 controller           |
| B | DeviceNet master          |
| C | DeviceNet slave           |
| D | Power supply unit, 24V DC |

*Continues on next page*

## 4 DeviceNet Master/Slave configuration

---

### 4.3.3. DeviceNet communication between two IRC5 controllers

*Continued*

---

#### How to configure the DeviceNet master-/slave controllers

| Step | Action   | Info/Illustration  |
|------|--|--|
| 1.   | Configure the slave controller according to the workflow for the internal DeviceNet slave.   | See <a href="#">How to use the internal DeviceNet slave on page 44</a> . |
| 2.   | Configure the master controller. Add unit that has the same address as the slave on the IRC5 slave controller, and with unit type DN_SLAVE.  | See <a href="#">Operator's manual - RobotStudio<sup>Online</sup></a> .   |
| 3.   | Configure signals on the created unit.   |  |
| 4.   | Physically interconnect the two IRC5 controllers. The power should only be connected to the bus cable in one place.<br><b>Note!</b> The shield should only be connected to earth at one point. |  |
| 5.   | Restart the master controller. The master should try to connect to the slave controller.   |  |
| 6.   | Now it is possible to set outputs on one controller. The outputs shall appear as inputs on the other controller.   |  |

## 4.4 Parameters

### 4.4.1. System parameters

#### Introduction

There are both DeviceNet specific parameters and more general parameters. This chapter gives brief descriptions of all system parameters that are necessary for correct installation and configuration of DeviceNet. The parameters are divided into the type they belong to.

The DeviceNet specific parameters are described here, for information about other system parameters refer to *Technical reference manual - System parameters*.

#### Type name Bus

These parameters belong to the topic I/O and the type Bus. For more information, see the respective parameter in *Technical reference manual - System parameters*.

| Parameter                     | Description   |
|-------------------------------|---|
| DeviceNet Master Address      | <p>This parameter is mandatory for a DeviceNet fieldbus and decides what address the master should use to communicate with other devices on the DeviceNet network.</p> <p>Before using this parameter either DeviceNet single or DeviceNet dual board option must be installed.</p> <p>A limitation is that there should not be another device on the network with the same address.</p> <p>Allowed values for this parameter are 0-63.</p>   |
| DeviceNet Communication Speed | <p>This parameter is mandatory for a DeviceNet fieldbus and decides what communication speed (baudrate) the DeviceNet master should use to communicate with other devices on the DeviceNet network.</p> <p>Before using this parameter either DeviceNet single or DeviceNet dual board option must be installed.</p> <p>A limitation is that all devices on the same physical DeviceNet network should use the same baudrate.</p> <p>Allowed values for this parameter are 125 kbps, 250 kbps and 500 kbps.</p> |

*Continues on next page*

## 4 DeviceNet Master/Slave configuration

---

### 4.4.1. System parameters

*Continued*

---

#### Type name Unit

These parameters belong to the topic I/O and the type Unit. For more information, see the respective parameter in *Technical reference manual - System parameters*.

| Parameter         | Description  |
|-------------------|--|
| DeviceNet Address | <p>This parameter is used to specify the address that the I/O unit is assumed to be using on the network, and which the master should try to setup a connection against.</p> <p>All addresses on a DeviceNet network must be unique. The only exception is that the master and the internal DeviceNet slave share the same address on the same board.</p> <p>Allowed values for this parameter are 0-63.</p> |

*Continues on next page*

## 4 DeviceNet Master/Slave configuration

### 4.4.1. System parameters

*Continued*

#### Type name Unit Type

These parameters belong to the topic I/O and the type Unit Type. For more information, see the respective parameter in *Technical reference manual - System parameters*.

| Parameter      | Description  |
|----------------|--|
| Vendor ID      | <p>This parameter is used as an identification of the I/O unit to secure communication to the correct device.</p> <p>The I/O unit vendor number is assigned by Open DeviceNet Vendor Associations (ODVA) to the vendor of the specific I/O unit.</p> <p>Value of this parameter could either be found in the Electronic Data Sheet (EDS) for the unit (called VendCode in EDS file), or by using the generic unit type (DN_GENERIC). See <a href="#">Configuration of third part units on page 40</a>.</p> <p>Allowed values for this parameter are 0-65535.</p> |
| Product Code   | <p>This parameter is used as an identification of the I/O unit to secure communication to the correct device. The I/O unit product code is defined by the vendor of the unit and shall be unique for the actual product type.</p> <p>Value of this parameter could either be found in the Electronic Data Sheet (EDS) for the unit (called ProdCode in EDS file), or by using the generic unit type (DN_GENERIC).</p> <p>Allowed values for this parameter are 0-65535.</p>  |
| Device Type    | <p>This parameter is used as an identification of the I/O unit to secure communication to the correct device.</p> <p>The I/O unit device type is as defined by Open DeviceNet Vendor Associations (ODVA).</p> <p>Value of this parameter could either be found in the Electronic Data Sheet (EDS) for the unit (called ProdType in EDS file), or by using the generic unit type (DN_GENERIC).</p> <p>Allowed values for this parameter are 0-65535.</p>  |
| Major Revision | <p>This parameter is used as information only and is a major part of the revision on the I/O unit.</p> <p>Value of this parameter could be found in the Electronic Data Sheet (EDS) for the unit (called MajRev in EDS file).</p> <p>Allowed values for this parameter are 0-255.</p>  |

*Continues on next page*

## 4 DeviceNet Master/Slave configuration

---

### 4.4.1. System parameters

*Continued*

| Parameter               | Description   |
|-------------------------|---|
| Minor Revision          | <p>This parameter is used as information only and is a minor part of the software revision of the I/O unit.</p> <p>Value of this parameter could be found in the Electronic Data Sheet (EDS) for the unit (called MinRev in EDS file).</p> <p>Allowed values for this parameter are 0-255.</p>  |
| Production Inhibit Time | <p>This parameter specifies the minimum time, expressed in milli seconds, between network messages sent by the unit.</p> <p>The parameter is used to control the minimum time between transmissions from the I/O unit in order to prevent overloading of the DeviceNet network.</p> <p>A limitation is that maximum and minimum values might be constrained by the unit.</p> <p>Allowed values for this parameter are 0-65535.</p>  |
| Explicit Messaging      | <p>This parameter enables DeviceNet Explicit connection to the I/O unit.</p> <p>The explicit connection is used for a Fieldbus Command Interface (FCI) from RAPID. For information refer to section "Fieldbus Command Interface" in <a href="#">Application manual - Robot communication and I/O control</a>, see <a href="#">References on page 12</a>.</p> <p>A limitation is that maximum size of an explicit message is 100 bytes, including service, path and other header information.</p> <p>Allowed values for this parameter are Enabled and Disabled.</p> |

*Continues on next page*

## 4 DeviceNet Master/Slave configuration

### 4.4.1. System parameters

*Continued*

| Parameter             | Description  |
|-----------------------|--|
| Connection 1 Type     | <p>This parameter specifies the type of the first connection that should be established to the unit.</p> <p>The parameter is used to define the communication scheme used towards the I/O unit. The different connection types are described in the ODVA DeviceNet specification (Open DeviceNet Vendor Associations).</p> <p>The type of connection supported by the I/O unit could either be found in the [IO_Info] section of the Electronic Data Sheet (EDS) for the unit, or by using the generic unit type (DN_GENERIC). See <a href="#">Configuration of third part units on page 40</a>.</p> <p>A limitation is that all connection types might not be supported by the unit.</p> <p>Following values are allowed for this parameter:</p> <ul style="list-style-type: none"><li>• Polled connection</li><li>• Strobe connection</li><li>• Change-Of-State (COS) connection</li><li>• Cyclic connection</li><li>• Change-Of-State with acknowledge suppression</li><li>• Cyclic with acknowledge suppression.</li></ul> |
| Connection 1 Interval | <p>This parameter defines the cyclicity of the communication over the first connection in milliseconds.</p> <p>The parameter is used to optimize network bandwidth and I/O update rates.</p> <p>A limitation is that if the parameter value is too low it will saturate the network. Maximum and minimum values might be constrained by the unit.</p> <p>Allowed values for this parameter are 0-65535.</p>  |

*Continues on next page*



## 4 DeviceNet Master/Slave configuration

---

### 4.4.1. System parameters

*Continued*

| Parameter                | Description   |
|--------------------------|---|
| Connection 1 Output Size | <p>This parameter defines the data size in bytes that is transmitted to the unit over the first connection.</p> <p>Value of this parameter could either be found in the [IO_Info] section of the Electronic Data Sheet (EDS) for the unit, or by using the generic unit type (DN_GENERIC). See <a href="#">Configuration of third part units on page 40</a>.</p> <p>A limitation is the maximum unit size for the Unit Type. Allowed values for this parameter are 0-128.</p> |
| Connection 1 Input Size  | <p>This parameter defines the data size in bytes received from the unit over the first connection.</p> <p>Value of this parameter could either be found in the [IO_Info] section of the Electronic Data Sheet (EDS) for the unit, or by using the generic unit type (DN_GENERIC). See <a href="#">Configuration of third part units on page 40</a>.</p> <p>A limitation is the maximum unit size for the Unit Type. Allowed values for this parameter are 0-128.</p>          |

*Continues on next page*

#### Type name Fieldbus Command Type

These parameters belong to the topic I/O and the type Fieldbus Command Type. For more information, see the respective parameter in *Technical reference manual - System parameters*.

| Parameter | Description  |
|-----------|--|
| Path      | <p>This parameter defines the path to DeviceNet object instance or attribute. Information to define this can usually be found in the [param] section of the EDS file.</p> <p>The parameter is used to describe the path to the instance or attribute, the data type identifier and the data size that are to be affected by the explicit message.</p> <p>Explicit messaging must be enabled.</p> <p>Allowed values for this parameter: String is defined in the ODVA DeviceNet Specification 2.0.</p>  |
| Service   | <p>This parameter defines the explicit service that should be performed on DeviceNet object instance or attribute pointed out in Path.</p> <p>Explicit messaging must be enabled. The services supported by the unit can usually be found in the EDS file for the I/O unit.</p> <p>Following values are allowed for this parameter:</p> <ul style="list-style-type: none"><li>• 0x05 (Reset)</li><li>• 0x08 (Create)</li><li>• 0x0D (Apply_Attributes)</li><li>• 0x0E (Set_Attribute_Single)</li></ul> |

## 4 DeviceNet Master/Slave configuration

---

### 4.4.1. System parameters

## 5 Boards and units

### 5.1 General

#### 5.1.1. DeviceNet Bus and I/O board status LED description

##### General

Each of the units connected to the DeviceNet Bus includes LED indicators which indicate the condition of the unit and the function of the network communication.

##### LEDs

The LEDs found on the units connected may be divided into two categories.

##### Common LEDs

The following LEDs can be found on all units:

- MS - Module status
- NS - Network status

##### Specific LEDs

Certain units also include the following LEDs:

- DeviceNet Tx - DeviceNet network transmit
- DeviceNet Rx - DeviceNet network receive

##### MS - Module status

This bicolor (green/red) LED indicates the status of the device. It indicates whether or not the device has power and is operating properly. The LED is controlled by software. The table below shows the different states of the MS LED.

| LED color    | Description                                | Remedy/Cause                        |
|--------------|--|-------------------------------------|
| OFF          | No power applied to the device.            | Check power supply.                 |
| GREEN steady | Device is operating in a normal condition. | If no light, check other LED modes. |

*Continues on next page*

## 5 Boards and units

### 5.1.1. DeviceNet Bus and I/O board status LED description

*Continued*

| LED color          | Description  | Remedy/Cause   |
|--------------------|--|--|
| GREEN flashing     | Device needs commissioning due to missing, incomplete or incorrect configuration. The device may be in the Stand-by state. | Check system parameters.<br>Check messages.              |
| RED flashing       | Recoverable minor fault.   | Check messages.  |
| RED steady         | The device has an unrecoverable fault.   | Device may need replacing.                               |
| RED/GREEN flashing | The device is running self test.   | If flashing for more than a few seconds, check hardware. |

### NS - Network status

This bicolor (green/red) LED indicates the status of the communication link. The LED is controlled by software. The table below shows the different states of the NS LED.

| LED color      | Description  | Remedy/Cause  |
|----------------|--|---|
| OFF            | Device has no power or is not on-line.<br>The device has not completed the Dup_MAC_ID test yet.  | Check status of MS LED.<br>Check power to affected module.  |
| GREEN steady   | The device is on-line and has connection in the established state.<br>For a group 2 device only: the device is allocated to a master.<br>For a UCMM capable device: the device has one or more established connections.  | If no light, check other LED modes.   |
| GREEN flashing | Device is on-line, but has no connections in the established state.<br>The device has passed the Dup_MAC_ID test, is on-line, but has no established connections to other nodes.<br>For a group 2 device only: the device is not allocated to a master.<br>For a UCMM capable device: the device has no established connections. | Check that other nodes in the network are operative.<br>Check parameter to see whether module has correct ID. |

*Continues on next page*

*Continued*

| LED color    | Description  | Remedy/Cause                          |
|--------------|--|---------------------------------------|
| RED flashing | One or more I/O connections are in the Time-Out state.   | Check system messages.                |
| RED steady   | Failed communication device. The device has detected an error rendering it incapable of communicating on the network.<br>(Duplicate MAC_ID, or Bus-off). | Check system messages and parameters. |

#### DeviceNet Tx - DeviceNet network transmit

The table below shows the different states of the DeviceNet Tx LED.

| LED color      | Description  | Remedy/Cause   |
|----------------|--|--|
| GREEN steady   | Physically connected to the DeviceNet Tx line.               | If no light when transmission is expected, check error messages.<br>Check system boards in rack. |
| GREEN flashing | Flashes when the CPU is receiving data on the DeviceNet bus. |  |

#### DeviceNet Rx - DeviceNet network receive

The table below shows the different states of the DeviceNet Rx LED.

| LED color      | Description   | Remedy/Cause                                |
|----------------|---|---|
| GREEN steady   | Physically connected to the DeviceNet Rx line.                  | If no light, check network and connections. |
| GREEN flashing | Flashes when the CPU is transmitting data on the DeviceNet bus. |   |

## 5 Boards and units

---

### 5.1.2. DeviceNet Bus status LEDs at power-up

#### 5.1.2. DeviceNet Bus status LEDs at power-up

---

##### Process

The system performs a test of the MS and NS LEDs during start-up. The purpose of this test is to check that all LEDs are working properly. The test runs as follows:

| Order | LED action  |
|-------|---|
| 1     | NS LED is switched Off.                               |
| 2     | MS LED is switched On green for approx. 0.25 seconds. |
| 3     | MS LED is switched On red for approx. 0.25 seconds.   |
| 4     | MS LED is switched On green.                          |
| 5     | NS LED is switched On green for approx. 0.25 seconds. |
| 6     | NS LED is switched On red for approx. 0.25 seconds.   |
| 7     | NS LED is switched On green.                          |

---

##### Additional LEDs

If a device has other LEDs, each LED is tested in sequence.

---

**5.1.3. External I/O units**

---

**General**

Up to 20 units may be connected to the same controller.

---

**Requirements**

| <b>Description</b>   | <b>Data/Value</b>                        | <b>More information in:</b>                                       |
|--|--|---|
| The maximum cable length between controller and external I/O unit. | 100 m                                    | <a href="#">Selecting cables on page 30</a>                       |
| Controller placement on cable chain.                               | At one end or anywhere between the ends. | -   |
| Power supply to I/O units  | 24 VDC                                   |   |
| Function of I/O units  | -  | Section <a href="#">5.2 Unit descriptions</a>                     |
| Termination of DeviceNet bus                                       | 121 ohm resistor                         | <a href="#">Termination resistors in DeviceNet bus on page 29</a> |



## 5 Boards and units

---

### 5.1.4. Coil neutralization

#### 5.1.4. Coil neutralization

---

##### External units

External relay coils, solenoids, and other units that will be connected to the controller must be neutralized. The figure below illustrates how this can be done.



##### NOTE!

The turn-off time for DC relays increases after neutralization, especially if a diode is connected across the coil. Varistors give shorter turn-off times. Neutralizing the coils lengthens the life of the switches that control them.

---

##### Clamping with a diode

The diode should be dimensioned for the same current as the relay coil, and a voltage of twice the supply voltage.

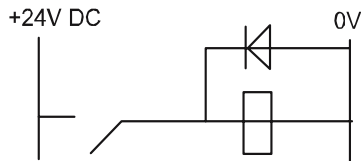

xx0100000163

---

##### Clamping with a varistor

The varistor should be dimensioned for the same current as the relay coil, and a voltage of twice the supply voltage.

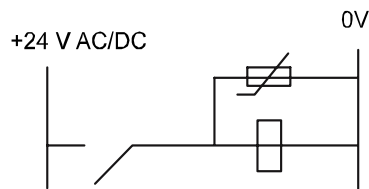

xx0100000164

---

*Continues on next page*

**Clamping with an RC circuit**

R 100 ohm, 1W C 0.1 - 1 mF.

>500V max. voltage, 125V nominal voltage.

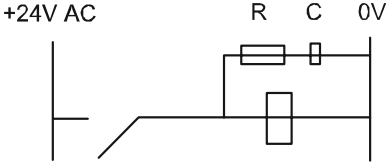

xx0100000165

## 5 Boards and units

### 5.1.5. Setting DeviceNet bus ID

#### 5.1.5. Setting DeviceNet bus ID

##### Description

Each I/O unit is given a unique address (ID).

##### How to set the ID

The connector contains address pins and can be keyed as shown in the figure below. When all terminals are unconnected the highest address is obtained, i.e. 63. When all terminals are connected to 0V, the address would be 0.

|                       |  |
|-----------------------|--|
| To obtain address 10: | Cut address pins 2 and 8 (see figure below!) |
| To obtain address 25: | Cut address pins 1, 8 and 16                 |

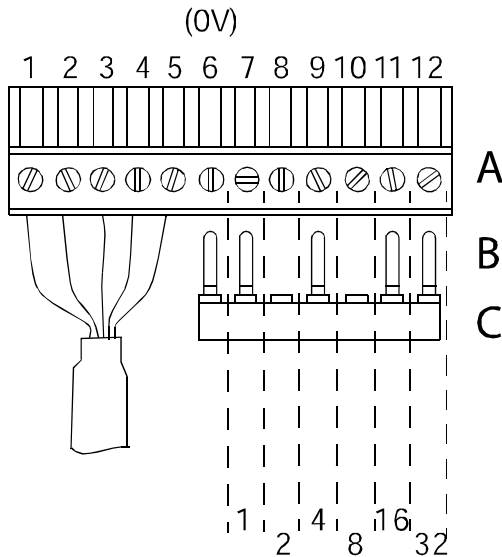

xx0100000245

|   |              |
|---|--------------|
| A | Connector X5 |
| B | Address pins |
| C | Address key  |

*Continues on next page*

---

#### Connector X5

Connector X5 is a DeviceNet connector. The table below shows the connections to connector X5:

| Signal name | X5 pin                     |
|-------------|----------------------------|
| 1           | Supply voltage GND - Black |
| 2           | CAN signal low - Blue      |
| 3           | Shield                     |
| 4           | CAN signal high - White    |
| 5           | Supply voltage 24VDC - Red |
| 6           | Logic GND                  |
| 7           | Board ID bit 0 (LSB)       |
| 8           | Board ID bit 1             |
| 9           | Board ID bit 2             |
| 10          | Board ID bit 3             |
| 11          | Board ID bit 4             |
| 12          | Board ID bit 5 (MSB)       |

## 5 Boards and units

---

### 5.2.1. Introduction

## 5.2 Unit descriptions

### 5.2.1. Introduction

---

#### Overview

This section includes descriptions of the different I/O units that support DeviceNet communication. Following units are described:

| Board designation | Name of unit                      | Type of unit           | Article number |
|-------------------|-----------------------------------|------------------------|----------------|
| DSQC 327A         | AD combi I/O                      | Distributed I/O unit   | 3HAC 17971-1   |
| DSQC 328A         | Digital I/O                       | Distributed I/O unit   | 3HAC 17970-1   |
| DSQC 332A         | Digital I/O with relay outputs    | Distributed I/O unit   | 3HAC 17973-1   |
| DSQC 355A         | Analog I/O                        | Distributed I/O unit   | 3HNE00554-1    |
| DSQC 350A         | DeviceNet/AllenBradley remote I/O | Gateway unit           | 3HNE00025-1    |
| DSQC 351A         | DeviceNet/INTERBUS                | Gateway unit           | 3HNE00006-1    |
| DSQC 352A         | DeviceNet/PROFIBUS-DP             | Gateway unit           | 3HNE00009-1    |
| DSQC 378A         | DeviceNet/CCLink                  | Gateway unit           |                |
| DSQC 377A         | Queue tracking                    | Encoder interface unit | 3HNE01586-1    |

### 5.2.2. DSQC 327A, AD combi I/O

#### Description

The DSQC 327A is a circuit board normally mounted inside the control module. As an option, it may also be mounted in an external I/O module.

The combi I/O unit handles digital and analog communication between the robot system and any external systems.

#### Illustration

The figure below shows the DSQC 327A unit:

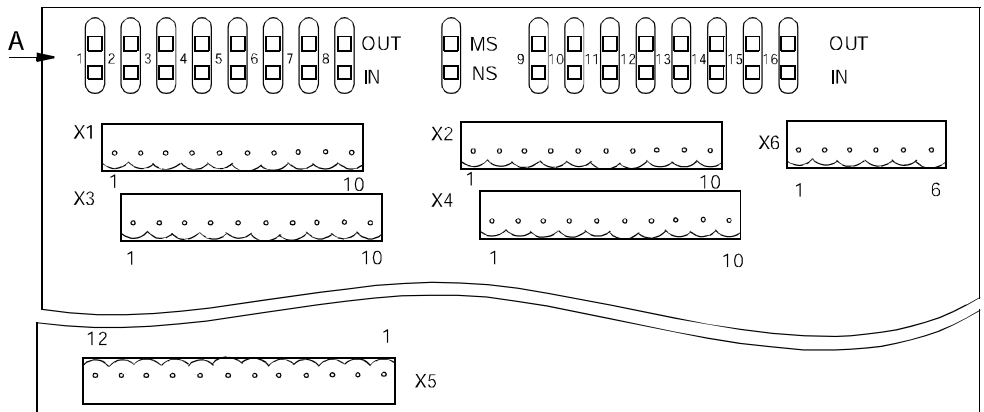

xx010000239

*Continues on next page*

## 5 Boards and units

---

### 5.2.2. DSQC 327A, AD combi I/O

*Continued*

---

#### Parts

The table below refers to the illustration in section [Illustration on page 65](#).

| Item | Description  |
|------|--|
| A    | Status LEDs  |
| X1   | Digital outputs<br>See <a href="#">Connector X1 on page 67</a> for connection table! |
| X2   | Digital outputs<br>See <a href="#">Connector X2 on page 68</a> for connection table! |
| X3   | Digital inputs<br>See <a href="#">Connector X3 on page 69</a> for connection table!  |
| X4   | Digital inputs<br>See <a href="#">Connector X4 on page 69</a> for connection table!  |
| X5   | DeviceNet connector<br>See <a href="#">Connector X5 on page 70!</a>                  |
| X6   | Analog outputs<br>See <a href="#">Connector X6 on page 71!</a>                       |

---

#### Facts, DSQC 327A

This section specifies a number of facts applicable to the DSQC 327A. Unless stated otherwise, the data applies to the standard version.

#### Technical data

|                        |   |
|------------------------|---|
| No. of digital inputs  | 16 (divided into two groups of 8, galvanically isolated from each other)                      |
| No. of digital outputs | 16 (divided into two groups of 8, galvanically isolated from each other)                      |
| No. of analog outputs  | 2 (galvanically isolated from the controller electronics)<br>0-10 V, 12 bit unsigned encoding |
| Supply voltage         | 24 VDC  |

*Continues on next page*

|                                      |  |
|--------------------------------------|--|
| Power supply, digital and analog I/O | <p>Integrated power supply in controller.</p> <p>Separate 24 VDC power, supplied by customer in non-ABB external I/O unit.</p>   |
| SW connections                       | <p>Support for the following connections:</p> <ul style="list-style-type: none"> <li>• Polled</li> <li>• Change-Of-State</li> <li>• Change-Of-State with acknowledge suppression</li> <li>• Cyclic</li> <li>• Cyclic with acknowledge suppression</li> </ul> <p>For descriptions of the different types of I/O connections, see <a href="#">I/O messages - connection types on page 15</a>.</p> <p><b>Note!</b> DSQC 327 (the previous version) only supports polled connection.</p> |

#### Unit setup

The unit must be given an ID address, and setup parameters must be entered into the system.

#### Connector X1

If supervision of the supply voltage is required, a bridge connection can be made to an optional digital input. This also requires the particular unit to have a separate power supply, in order to be able to monitor the regular power supply voltage.

The supervision instruction must be written in the RAPID program.

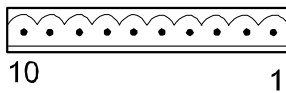

xx0200000264

The table below shows the connections to connector X1:

| Unit function             | Signal name | X1 pin |
|---------------------------|-------------|--------|
| Optically isolated output | Out ch 1    | 1      |
| Optically isolated output | Out ch 2    | 2      |
| Optically isolated output | Out ch 3    | 3      |

*Continues on next page*



## 5 Boards and units

### 5.2.2. DSQC 327A, AD combi I/O

*Continued*

| Unit function             | Signal name          | X1 pin |
|---------------------------|----------------------|--------|
| Optically isolated output | Out ch 4             | 4      |
| Optically isolated output | Out ch 5             | 5      |
| Optically isolated output | Out ch 6             | 6      |
| Optically isolated output | Out ch 7             | 7      |
| Optically isolated output | Out ch 8             | 8      |
| Optically isolated output | 0 V for outputs 1-8  | 9      |
| Optically isolated output | 24 V for outputs 1-8 | 10     |

#### Connector X2

If supervision of the supply voltage is required, a bridge connection can be made to an optional digital input. The supervision instruction must be written in the RAPID program.

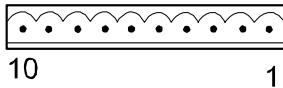

xx0200000264

The table below shows the connections to connector X2:

| Unit function             | Signal name           | X2 pin |
|---------------------------|-----------------------|--------|
| Optically isolated output | Out ch 9              | 1      |
| Optically isolated output | Out ch 10             | 2      |
| Optically isolated output | Out ch 11             | 3      |
| Optically isolated output | Out ch 12             | 4      |
| Optically isolated output | Out ch 13             | 5      |
| Optically isolated output | Out ch 14             | 6      |
| Optically isolated output | Out ch 15             | 7      |
| Optically isolated output | Out ch 16             | 8      |
| Optically isolated output | 0 V for outputs 9-16  | 9      |
| Optically isolated output | 24 V for outputs 9-16 | 10     |

*Continues on next page*

Connector X3

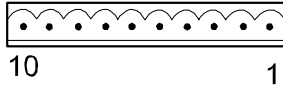

xx0200000264

The table below shows the connections to connector X3:

| Unit function            | Signal name        | X3 pin |
|--------------------------|--------------------|--------|
| Optically isolated input | In ch 1            | 1      |
| Optically isolated input | In ch 2            | 2      |
| Optically isolated input | In ch 3            | 3      |
| Optically isolated input | In ch 4            | 4      |
| Optically isolated input | In ch 5            | 5      |
| Optically isolated input | In ch 6            | 6      |
| Optically isolated input | In ch 7            | 7      |
| Optically isolated input | In ch 8            | 8      |
| Optically isolated input | 0 V for inputs 1-8 | 9      |
| Optically isolated input | Not used           | 10     |

The input current is 5.5 mA (at 24V) on the digital inputs. A capacitor connected to ground, to prevent disturbances, causes a short rush of current when setting the input.

When connecting outputs, sensitive to pre-oscillation current, a series resistor (100 Ohms) may be used.

Connector X4

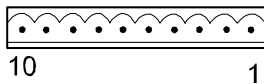

xx0200000264

*Continues on next page*

## 5 Boards and units

### 5.2.2. DSQC 327A, AD combi I/O

*Continued*

The table below shows the connections to connector X4:

| Unit function            | Signal name         | X4 pin |
|--------------------------|---------------------|--------|
| Optically isolated input | In ch 9             | 1      |
| Optically isolated input | In ch 10            | 2      |
| Optically isolated input | In ch 11            | 3      |
| Optically isolated input | In ch 12            | 4      |
| Optically isolated input | In ch 13            | 5      |
| Optically isolated input | In ch 14            | 6      |
| Optically isolated input | In ch 15            | 7      |
| Optically isolated input | In ch 16            | 8      |
| Optically isolated input | 0 V for inputs 9-16 | 9      |
| Optically isolated input | Not used            | 10     |

The input current is 5.5 mA (at 24V) on the digital inputs. A capacitor connected to ground, to prevent disturbances, causes a short rush of current when setting the input.

When connecting outputs, sensitive to pre-oscillation current, a series resistor (100 Ohms) may be used.

#### Connector X5



xx0100000244

Connector X5 is a DeviceNet connector specified in section [Setting DeviceNet bus ID on page 62](#).

*Continues on next page*

Connector X6

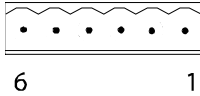

xx0200000265

The table below shows the connections to connector X6:

| Signal name | X6 pin | Explanation              |
|-------------|--------|--------------------------|
| -           | 1      | No connection            |
| -           | 2      | No connection            |
| -           | 3      | No connection            |
| 0 VA        | 4      | 0 V for Out channels 1-2 |
| AN_OCH1     | 5      | Out channels 1           |
| AN_OCH2     | 6      | Out channels 2           |

LEDs

The significance of the LEDs are specified in section [DeviceNet Bus and I/O board status LED description on page 55](#).

Input map

The figure below shows the digital input mapping.

| Input byte | Bit   |       |       |       |       |       |       |      | Bit range |
|------------|-------|-------|-------|-------|-------|-------|-------|------|-----------|
|            | 7     | 6     | 5     | 4     | 3     | 2     | 1     | 0    |           |
| 0          | DI 8  | DI 7  | DI 6  | DI 5  | DI 4  | DI 3  | DI 2  | DI 1 | 0-7       |
| 1          | DI 16 | DI 15 | DI 14 | DI 13 | DI 12 | DI 11 | DI 10 | DI 9 | 8-15      |

xx0300000613

Continues on next page

## 5 Boards and units

### 5.2.2. DSQC 327A, AD combi I/O

*Continued*

#### Output map

The figure below shows the analog and digital output mapping.

**Note!** Pay attention to the order of the bits for the analog signals.

| Output byte | Bit   |       |       |       |       |       |       |      | Bit range |       |
|-------------|-------|-------|-------|-------|-------|-------|-------|------|-----------|-------|
|             | 7     | 6     | 5     | 4     | 3     | 2     | 1     | 0    |           |       |
| 0           | AO 1  |       |       |       |       |       |       |      | LSB       | 0-15  |
| 1           |       |       |       |       |       |       |       |      |           |       |
| 2           | AO 2  |       |       |       |       |       |       |      | LSB       | 16-31 |
| 3           |       |       |       |       |       |       |       |      |           |       |
| 4           | DO 8  | DO 7  | DO 6  | DO 5  | DO 4  | DO 3  | DO 2  | DO 1 | 32-39     |       |
| 5           | DO 16 | DO 15 | DO 14 | DO 13 | DO 12 | DO 11 | DO 10 | DO 9 | 40-47     |       |

xx0300000532

|     |   |
|-----|---|
| LSB | The <i>least</i> significant bit of the binary number representing the analog signal. |
| MSB | The <i>most</i> significant bit of the binary number representing the analog signal.  |

*Continues on next page*

#### Numerical format

The numerical representation of the values are described in the table below:

| Signal    | Analog physical value | Hexadecimal number | Bit value         |
|-----------|-----------------------|--------------------|-------------------|
| AO 1-AO 2 | +10 V                 | 0xFFFF             | MaxBitVal = 65535 |
| AO 1-AO 2 | +5 V                  | 0x7FFF             |                   |
| AO 1-AO 2 | 0 V                   | 0x0                | MinBitVal = 0     |

#### Additional information

The table shows the physical type of the signals, resolution etc.

| Signal | Type    | Range        | Resolution | Encoding type |
|--------|---------|--------------|------------|---------------|
| AO 1   | Voltage | 0 V .. +10 V | 12 bit     | Unsigned      |
| AO 2   | Voltage | 0 V .. +10 V | 12 bit     | Unsigned      |

## 5 Boards and units

### 5.2.3. DSQC 328A, Digital I/O

#### 5.2.3. DSQC 328A, Digital I/O

##### Description

The DSQC 328A is a circuit board normally mounted inside the control module. As an option, it may also be mounted in an external I/O module.

The unit handles digital input and output signals between the robot system and any external systems.

##### Illustration

The figure below shows the DSQC 328A board:

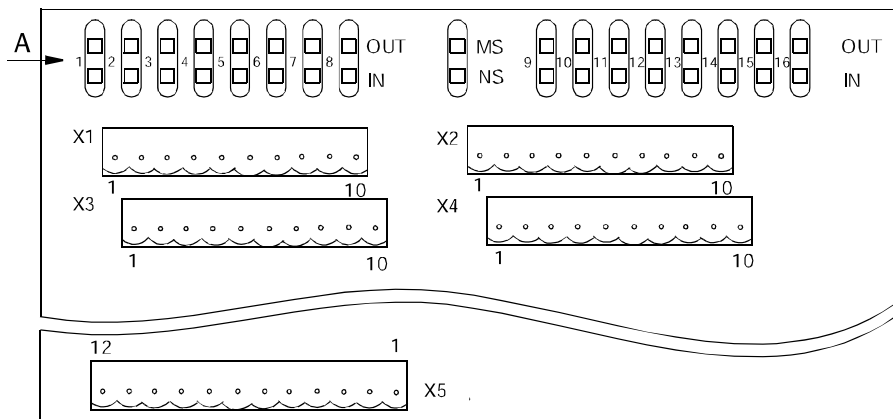

xx0100000240

*Continues on next page*

**Parts**

The table below refers to the illustration in section *Illustration on page 74*.

| Item | Description   |
|------|---|
| A    | Status LEDs   |
| X1   | Digital outputs<br>See section <i>Connector X1 on page 76</i> for connection table! |
| X2   | Digital outputs<br>See <i>Connector X2 on page 77</i> for connection table!         |
| X3   | Digital inputs<br>See <i>Connector X3 on page 78</i> for connection table!          |
| X4   | Digital inputs<br>See <i>Connector X4 on page 79</i> for connection table!          |
| X5   | DeviceNet connector<br>See <i>Connector X5 on page 79!</i>                          |

**Facts, DSQC 328**

This section specifies a number of facts applicable to the DSQC 328A. Unless stated otherwise, the data applies to the standard version.

## Technical data

|                |  |
|----------------|--|
| No. of inputs  | 16 (divided into two groups of 8, galvanically isolated from each other) |
| No. of outputs | 16 (divided into two groups of 8, galvanically isolated from each other) |
| Supply voltage | 24 VDC   |

*Continues on next page*



## 5 Boards and units

### 5.2.3. DSQC 328A, Digital I/O

*Continued*

|                |   |
|----------------|---|
| Supply source  | 24 V I/O or separate external supply  |
| SW connections | Support for the following connections: <ul style="list-style-type: none"><li>• Polled</li><li>• Change-Of-State</li><li>• Change-Of-State with acknowledge suppression</li><li>• Cyclic</li><li>• Cyclic with acknowledge suppression</li></ul> For descriptions of the different types of I/O connections, see <a href="#">I/O messages - connection types on page 15</a> .<br><b>Note!</b> DSQC 328 (the previous version) only supports polled connection. |

#### Unit setup

The unit must be given an ID address, and setup parameters must be entered into the system.

#### Connector X1

If supervision of the supply voltage is required, a bridge connection can be made to an optional digital input. The supervision instruction must be written in the RAPID program.

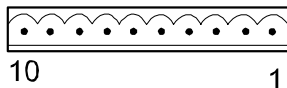

xx0200000264

The table below shows the connections to connector X1:

| Unit function             | Signal name | X1 pin |
|---------------------------|-------------|--------|
| Optically isolated output | Out ch 1    | 1      |
| Optically isolated output | Out ch 2    | 2      |
| Optically isolated output | Out ch 3    | 3      |
| Optically isolated output | Out ch 4    | 4      |
| Optically isolated output | Out ch 5    | 5      |
| Optically isolated output | Out ch 6    | 6      |
| Optically isolated output | Out ch 7    | 7      |
| Optically isolated output | Out ch 8    | 8      |

*Continues on next page*

| Unit function             | Signal name          | X1 pin |
|---------------------------|----------------------|--------|
| Optically isolated output | 0 V for outputs 1-8  | 9      |
| Optically isolated output | 24 V for outputs 1-8 | 10     |

Connector X2

If supervision of the supply voltage is required, a bridge connection can be made to an optional digital input. The supervision instruction must be written in the RAPID program.

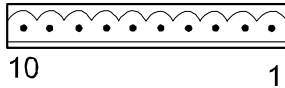

xx0200000264

The table below shows the connections to connector X2:

| Unit function             | Signal name           | X2 pin |
|---------------------------|-----------------------|--------|
| Optically isolated output | Out ch 9              | 1      |
| Optically isolated output | Out ch 10             | 2      |
| Optically isolated output | Out ch 11             | 3      |
| Optically isolated output | Out ch 12             | 4      |
| Optically isolated output | Out ch 13             | 5      |
| Optically isolated output | Out ch 14             | 6      |
| Optically isolated output | Out ch 15             | 7      |
| Optically isolated output | Out ch 16             | 8      |
| Optically isolated output | 0 V for outputs 9-16  | 9      |
| Optically isolated output | 24 V for outputs 9-16 | 10     |

*Continues on next page*

## 5 Boards and units

### 5.2.3. DSQC 328A, Digital I/O

*Continued*

#### Connector X3

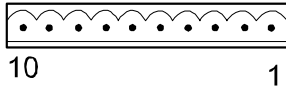

xx0200000264

The table below shows the connections to connector X3:

| Unit function            | Signal name        | X3 pin |
|--------------------------|--------------------|--------|
| Optically isolated input | In ch 1            | 1      |
| Optically isolated input | In ch 2            | 2      |
| Optically isolated input | In ch 3            | 3      |
| Optically isolated input | In ch 4            | 4      |
| Optically isolated input | In ch 5            | 5      |
| Optically isolated input | In ch 6            | 6      |
| Optically isolated input | In ch 7            | 7      |
| Optically isolated input | In ch 8            | 8      |
| Optically isolated input | 0 V for inputs 1-8 | 9      |
| Optically isolated input | Not used           | 10     |

The input current is 5.5 mA (at 24V) on the digital inputs. A capacitor connected to ground, to prevent disturbances, causes a short rush of current when setting the input.

When connecting outputs, sensitive to pre-oscillation current, a series resistor (100 Ohms) may be used.

*Continues on next page*

Connector X4

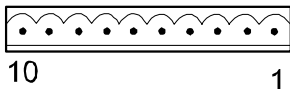

xx0200000264

The table below shows the connections to connector X4:

| Unit function            | Signal name         | X4 pin |
|--------------------------|---------------------|--------|
| Optically isolated input | In ch 9             | 1      |
| Optically isolated input | In ch 10            | 2      |
| Optically isolated input | In ch 11            | 3      |
| Optically isolated input | In ch 12            | 4      |
| Optically isolated input | In ch 13            | 5      |
| Optically isolated input | In ch 14            | 6      |
| Optically isolated input | In ch 15            | 7      |
| Optically isolated input | In ch 16            | 8      |
| Optically isolated input | 0 V for inputs 9-16 | 9      |
| Optically isolated input | Not used            | 10     |

The input current is 5.5 mA (at 24V) on the digital inputs. A capacitor connected to ground, to prevent disturbances, causes a short rush of current when setting the input.

When connecting outputs, sensitive to pre-oscillation current, a series resistor (100 ohms) may be used.

Connector X5

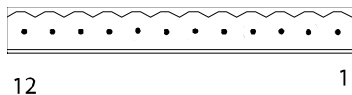

xx0100000244

Connector X5 is a DeviceNet connector specified in section [Setting DeviceNet bus ID on page 62](#).

Continues on next page

## 5 Boards and units

### 5.2.3. DSQC 328A, Digital I/O

*Continued*

#### LEDs

The significance of the LEDs are specified in section *DeviceNet Bus and I/O board status LED description on page 55*.

#### Input map

The figure below shows the digital input mapping.

| Input byte | Bit      |          |          |          |          |          |          |         | Bit range |
|------------|----------|----------|----------|----------|----------|----------|----------|---------|-----------|
|            | 7        | 6        | 5        | 4        | 3        | 2        | 1        | 0       |           |
| 0          | DI<br>8  | DI<br>7  | DI<br>6  | DI<br>5  | DI<br>4  | DI<br>3  | DI<br>2  | DI<br>1 | 0-7       |
| 1          | DI<br>16 | DI<br>15 | DI<br>14 | DI<br>13 | DI<br>12 | DI<br>11 | DI<br>10 | DI<br>9 | 8-15      |

xx0300000613

#### Output map

The figure below shows the digital output mapping.

| Output byte | Bit      |          |          |          |          |          |          |         | Bit range |
|-------------|----------|----------|----------|----------|----------|----------|----------|---------|-----------|
|             | 7        | 6        | 5        | 4        | 3        | 2        | 1        | 0       |           |
| 0           | DO<br>8  | DO<br>7  | DO<br>6  | DO<br>5  | DO<br>4  | DO<br>3  | DO<br>2  | DO<br>1 | 0-7       |
| 1           | DO<br>16 | DO<br>15 | DO<br>14 | DO<br>13 | DO<br>12 | DO<br>11 | DO<br>10 | DO<br>9 | 8-15      |

en0400000716

5.2.4. DSQC 332A, Digital I/O with relay outputs

Description

The DSQC 332A is a circuit board normally mounted inside the control module. As an option, it may also be mounted in an external I/O module.

The unit handles input and output signals between the robot system and any external systems through relay outputs and digital inputs.

Illustration

The figure below shows the DSQC 332A board:

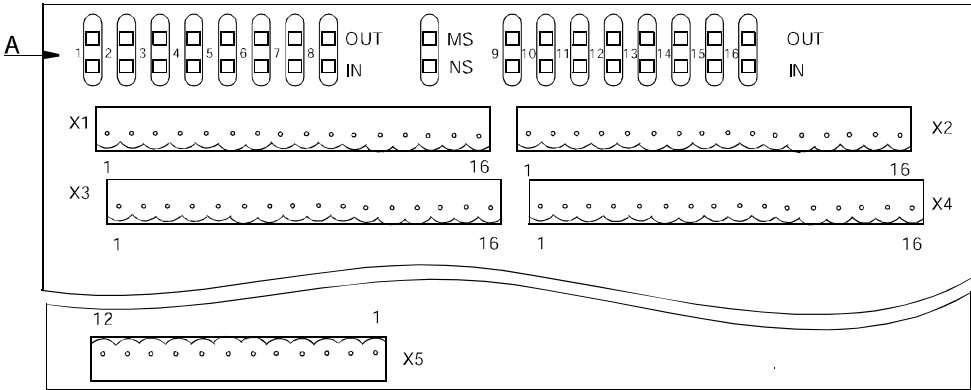

xx0100000232

Continues on next page

## 5 Boards and units

---

### 5.2.4. DSQC 332A, Digital I/O with relay outputs

*Continued*

---

#### Parts

The table below refers to the illustration in section *Illustration on page 81*.

| Item | Description   |
|------|---|
| A    | Status LEDs   |
| X1   | Relay outputs<br>See section <a href="#">Connector X1 on page 85</a> for connection table!  |
| X2   | Relay outputs<br>See section <a href="#">Connector X2 on page 86</a> for connection table!  |
| X3   | Digital inputs<br>See section <a href="#">Connector X3 on page 87</a> for connection table! |
| X4   | Digital inputs<br>See section <a href="#">Connector X4 on page 88</a> for connection table! |
| X5   | DeviceNet connector<br>See section <a href="#">Connector X5 on page 89</a> !                |

*Continues on next page*

#### Facts, DSQC 332A

This section specifies a number of facts applicable to the DSQC 332A. Unless stated otherwise, the data applies to the standard version.

#### Technical data

|                       |   |
|-----------------------|---|
| No. of digital inputs | 16 (divided into two groups of 8, galvanically isolated from each other)  |
| No. of relay outputs  | 16 (a single normally open contact, isolated from each other)   |
| Digital inputs        | Rated voltage: 24 VDC<br>Input voltage range: "1" 15 to 35 VDC, "0" -35 to 5 VDC  |
| Digital outputs       | Rated voltage: 24 VDC<br>Max output current: 2A/channel   |
| Supply voltage        | 24 VDC  |
| Supply source         | 24 V I/O or separate external supply  |
| SW connections        | Support for the following connections: <ul style="list-style-type: none"> <li>• Polled</li> <li>• Change-Of-State</li> <li>• Change-Of-State with acknowledge suppression</li> <li>• Cyclic</li> <li>• Cyclic with acknowledge suppression</li> </ul> For descriptions of the different types of I/O connections, see <a href="#">I/O messages - connection types on page 15</a> .<br><b>Note!</b> DSQC 332 (the previous version) only supports polled connection. |

#### Unit setup

The unit must be given an ID address, and setup parameters must be entered into the system.

*Continues on next page*



## 5 Boards and units

### 5.2.4. DSQC 332A, Digital I/O with relay outputs

*Continued*

#### Connecting digital outputs and digital inputs

The following illustration shows how to connect the relay outputs for the connectors X1 and X2. When a bit is set to 1, the relay output will be activated.

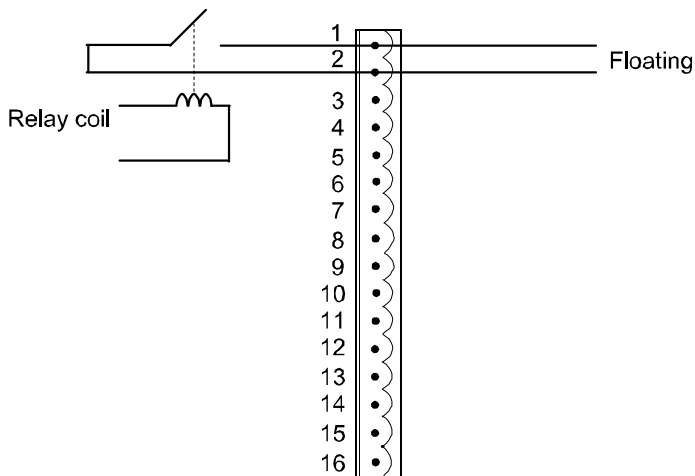

en0500001565

The following illustration shows how to connect the digital inputs for the connectors X3 and X4.

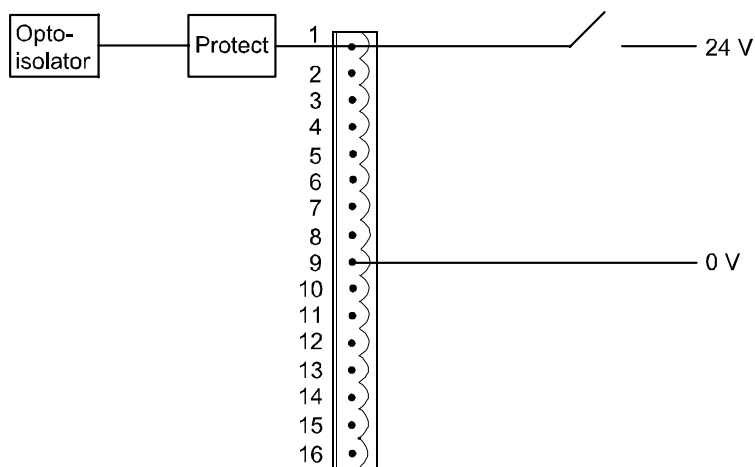

en0500001566

*Continues on next page*

#### Connector X1

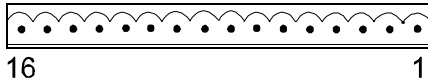

xx0100000235

The table below shows the connections to connector X1:

| Signal name | X1 pin | Function         |
|-------------|--------|------------------|
| Out ch 1a   | 1      | Contact, relay 1 |
| Out ch 1b   | 2      | Contact, relay 1 |
| Out ch 2a   | 3      | Contact, relay 2 |
| Out ch 2b   | 4      | Contact, relay 2 |
| Out ch 3a   | 5      | Contact, relay 3 |
| Out ch 3b   | 6      | Contact, relay 3 |
| Out ch 4a   | 7      | Contact, relay 4 |
| Out ch 4b   | 8      | Contact, relay 4 |
| Out ch 5a   | 9      | Contact, relay 5 |
| Out ch 5b   | 10     | Contact, relay 5 |
| Out ch 6a   | 11     | Contact, relay 6 |
| Out ch 6b   | 12     | Contact, relay 6 |
| Out ch 7a   | 13     | Contact, relay 7 |
| Out ch 7b   | 14     | Contact, relay 7 |
| Out ch 8a   | 15     | Contact, relay 8 |
| Out ch 8b   | 16     | Contact, relay 8 |

*Continues on next page*

## 5 Boards and units

### 5.2.4. DSQC 332A, Digital I/O with relay outputs

*Continued*

Connector X2

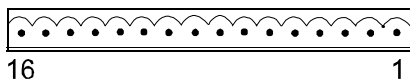

xx0100000235

The table below shows the connections to connector X2:

| Signal name | X2 pin | Function          |
|-------------|--------|-------------------|
| Out ch 9a   | 1      | Contact, relay 9  |
| Out ch 9b   | 2      | Contact, relay 9  |
| Out ch 10a  | 3      | Contact, relay 10 |
| Out ch 10b  | 4      | Contact, relay 10 |
| Out ch 11a  | 5      | Contact, relay 11 |
| Out ch 11b  | 6      | Contact, relay 11 |
| Out ch 12a  | 7      | Contact, relay 12 |
| Out ch 12b  | 8      | Contact, relay 12 |
| Out ch 13a  | 9      | Contact, relay 13 |
| Out ch 13b  | 10     | Contact, relay 13 |
| Out ch 14a  | 11     | Contact, relay 14 |
| Out ch 14b  | 12     | Contact, relay 14 |
| Out ch 15a  | 13     | Contact, relay 15 |
| Out ch 15b  | 14     | Contact, relay 15 |
| Out ch 16a  | 15     | Contact, relay 16 |
| Out ch 16b  | 16     | Contact, relay 16 |

*Continues on next page*

Connector X3

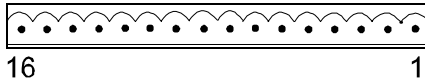

xx0100000235

The table below shows the connections to connector X3:

| Signal name       | X3 pin |
|-------------------|--------|
| In ch 1           | 1      |
| In ch 2           | 2      |
| In ch 3           | 3      |
| In ch 4           | 4      |
| In ch 5           | 5      |
| In ch 6           | 6      |
| In ch 7           | 7      |
| In ch 8           | 8      |
| 0 v for In ch 1-8 | 9      |
| Not used          | 10     |
| Not used          | 11     |
| Not used          | 12     |
| Not used          | 13     |
| Not used          | 14     |
| Not used          | 15     |
| Not used          | 16     |

The input current is 5.5 mA (at 24V) on the digital inputs. A capacitor connected to ground, to prevent disturbances, causes a short rush of current when setting the input.

When connecting outputs, sensitive to pre-oscillation current, a series resistor (100 Ohms) may be used.

*Continues on next page*

## 5 Boards and units

### 5.2.4. DSQC 332A, Digital I/O with relay outputs

*Continued*

#### Connector X4

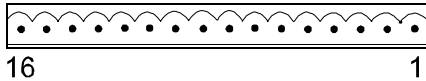

xx0100000235

The table below shows the connections to connector X4:

| Signal name        | X4 pin |
|--------------------|--------|
| In ch 9            | 1      |
| In ch 10           | 2      |
| In ch 11           | 3      |
| In ch 12           | 4      |
| In ch 13           | 5      |
| In ch 14           | 6      |
| In ch 15           | 7      |
| In ch 16           | 8      |
| 0 v for In ch 9-16 | 9      |
| Not used           | 10     |
| Not used           | 11     |
| Not used           | 12     |
| Not used           | 13     |
| Not used           | 14     |
| Not used           | 15     |
| Not used           | 16     |

The input current is 5.5 mA (at 24V) on the digital inputs. A capacitor connected to ground, to prevent disturbances, causes a short rush of current when setting the input.

When connecting outputs, sensitive to pre-oscillation current, a series resistor (100 Ohms) may be used.

*Continues on next page*

Connector X5

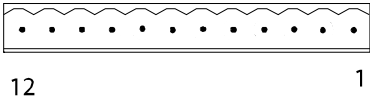

xx0100000244

Connector X5 is a DeviceNet connector specified in section *Setting DeviceNet bus ID*.

LEDs

The significance of the LEDs are specified in section *Setting DeviceNet bus ID on page 62*.

Input map

The figure below shows the digital input mapping.

| Input byte | Bit   |       |       |       |       |       |       |      | Bit range |
|------------|-------|-------|-------|-------|-------|-------|-------|------|-----------|
|            | 7     | 6     | 5     | 4     | 3     | 2     | 1     | 0    |           |
| 0          | DI 8  | DI 7  | DI 6  | DI 5  | DI 4  | DI 3  | DI 2  | DI 1 | 0-7       |
| 1          | DI 16 | DI 15 | DI 14 | DI 13 | DI 12 | DI 11 | DI 10 | DI 9 | 8-15      |

xx0300000613

Output map

The figure below shows the digital output mapping.

| Output byte | Bit   |       |       |       |       |       |       |      | Bit range |
|-------------|-------|-------|-------|-------|-------|-------|-------|------|-----------|
|             | 7     | 6     | 5     | 4     | 3     | 2     | 1     | 0    |           |
| 0           | DO 8  | DO 7  | DO 6  | DO 5  | DO 4  | DO 3  | DO 2  | DO 1 | 0-7       |
| 1           | DO 16 | DO 15 | DO 14 | DO 13 | DO 12 | DO 11 | DO 10 | DO 9 | 8-15      |

en0400000716

## 5 Boards and units

### 5.2.5. DSQC 355A, Analog I/O

### 5.2.5. DSQC 355A, Analog I/O

#### Description

The DSQC 355A is a circuit board normally mounted inside the control module. As an option, it may also be mounted in an external I/O module.

The unit handles interface between the robot system and any external systems through analog input and output signals.

#### Illustration

The figure below shows the DSQC 355A board:

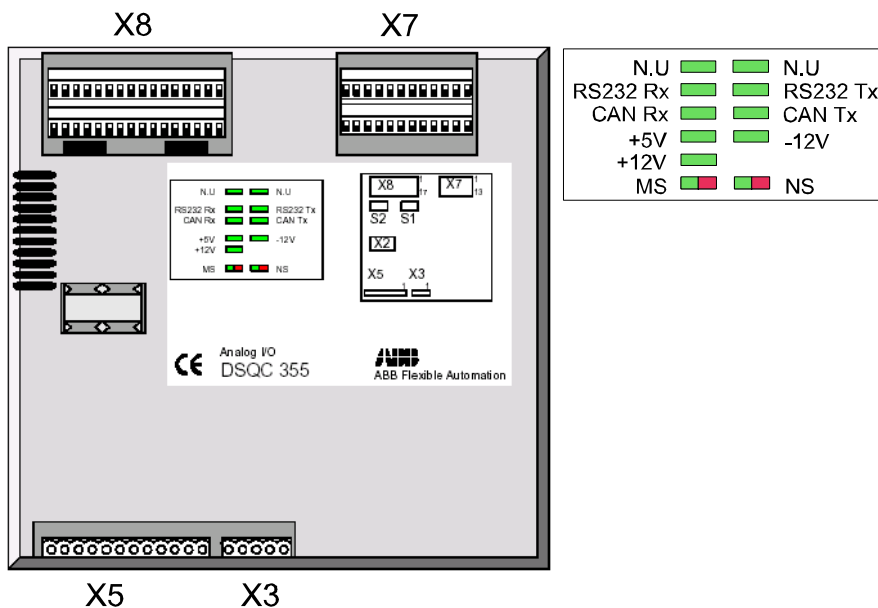

xx0100000238

*Continues on next page*

#### Parts

The table below refers to the illustration in section *Illustration on page 90*.

| Item | Description   |
|------|---|
| X3   | Back-up feed supply<br>See section <a href="#">Connector X3 on page 92</a> for connection tables! |
| X5   | DeviceNet connector<br>See section <a href="#">Connector X5 on page 92</a> !                      |
| X7   | Analog outputs<br>See section <a href="#">Connector X7 on page 93</a> for connection tables!      |
| X8   | Analog inputs<br>See section <a href="#">Connector X8 on page 94</a> for connection tables!       |

#### Facts, DSQC 355A

This section specifies a number of facts applicable to the DSQC 355A. Unless stated otherwise, the data applies to the standard version.

#### Technical data

|                |   |
|----------------|---|
| SW connections | Support for the following connections: <ul style="list-style-type: none"> <li>• Polled</li> <li>• Change-Of-State</li> <li>• Change-Of-State with acknowledge suppression</li> </ul> For descriptions of the different types of I/O connections, see <a href="#">I/O messages - connection types on page 15</a> . |
|----------------|---|

#### Unit ID and setup

The unit must be given an ID address, and setup parameters must be entered into the system.

*Continues on next page*



## 5 Boards and units

### 5.2.5. DSQC 355A, Analog I/O

*Continued*

#### Connector X3

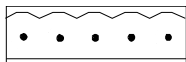

5 1

xx0100000221

The table below shows the connections to connector X3:

| Signal name | X3 pin | Function                |
|-------------|--------|-------------------------|
| 0 VDC       | 1      | Supply voltage GND      |
| NC          | 2      | Not connected           |
| GND         | 3      | Ground connection       |
| NC          | 4      | Not connected           |
| + 24 VDC    | 5      | Supply voltage + 24 VDC |

#### Connector X5



12 1

xx0100000244

Connector X5 is a DeviceNet connector further described in section [Setting DeviceNet bus ID on page 62](#).

*Continues on next page*

**Connector X7**

The table below shows the connections to connector X7:

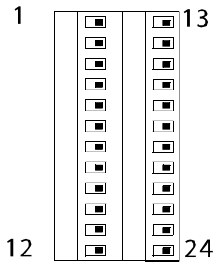

xx0100000236

| Signal name | X7 pin | Function                     |
|-------------|--------|------------------------------|
| ANOUT_1     | 1      | Analog output 1, -10 V/+10 V |
| ANOUT_2     | 2      | Analog output 2, -10 V/+10 V |
| ANOUT_3     | 3      | Analog output 3, -10 V/+10 V |
| ANOUT_4     | 4      | Analog output 4, 4-20 mA     |
| Not used    | 5      |                              |
| Not used    | 6      |                              |
| Not used    | 7      |                              |
| Not used    | 8      |                              |
| Not used    | 9      |                              |
| Not used    | 10     |                              |
| Not used    | 11     |                              |
| Not used    | 12     |                              |
| Not used    | 13     |                              |
| Not used    | 14     |                              |
| Not used    | 15     |                              |
| Not used    | 16     |                              |
| Not used    | 17     |                              |
| Not used    | 18     |                              |

*Continues on next page*

## 5 Boards and units

### 5.2.5. DSQC 355A, Analog I/O

*Continued*

| Signal name | X7 pin | Function             |
|-------------|--------|----------------------|
| GND         | 19     | Analog output 1, 0 V |
| GND         | 20     | Analog output 2, 0 V |
| GND         | 21     | Analog output 3, 0 V |
| GND         | 22     | Analog output 4, 0 V |
| GND         | 23     |                      |
| GND         | 24     |                      |

**Note!** The load on analog outputs on current mode must always be between 500-1000 ohm.

#### Connector X8

The table below shows the connections to connector X8:

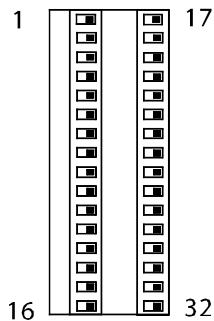

xx0100000237

| Signal name | X8 pin | Function                    |
|-------------|--------|-----------------------------|
| ANIN_1      | 1      | Analog input 1, -10 V/+10 V |
| ANIN_2      | 2      | Analog input 2, -10 V/+10 V |
| ANIN_3      | 3      | Analog input 3, -10 V/+10 V |
| ANIN_4      | 4      | Analog input 4, -10 V/+10 V |
| Not used    | 5      |                             |
| Not used    | 6      |                             |
| Not used    | 7      |                             |

*Continues on next page*

| <b>Signal name</b> | <b>X8 pin</b> | <b>Function</b>     |
|--------------------|---------------|---------------------|
| Not used           | 8             |                     |
| Not used           | 9             |                     |
| Not used           | 10            |                     |
| Not used           | 11            |                     |
| Not used           | 12            |                     |
| Not used           | 13            |                     |
| Not used           | 14            |                     |
| Not used           | 15            |                     |
| Not used           | 16            |                     |
| +24 V out          | 17            | +24 VDC supply      |
| +24 V out          | 18            | +24 VDC supply      |
| +24 V out          | 19            | +24 VDC supply      |
| +24 V out          | 20            | +24 VDC supply      |
| +24 V out          | 21            | +24 VDC supply      |
| +24 V out          | 22            | +24 VDC supply      |
| +24 V out          | 23            | +24 VDC supply      |
| +24 V out          | 24            | +24 VDC supply      |
| GND                | 25            | Analog input 1, 0 V |
| GND                | 26            | Analog input 2, 0 V |
| GND                | 27            | Analog input 3, 0 V |
| GND                | 28            | Analog input 4, 0 V |
| GND                | 29            |                     |
| GND                | 30            |                     |
| GND                | 31            |                     |
| GND                | 32            |                     |

*Continues on next page*

## 5 Boards and units

---

### 5.2.5. DSQC 355A, Analog I/O

*Continued*

#### Board specific LEDs

The designations refer to LEDs shown in the figure in section [Illustration on page 90](#).

| Designation             | Color | Description   |
|-------------------------|-------|---|
| RS232 Rx                | Green | Indicates the state of the RS232 Rx line. LED is active when receiving data. If there is no light, check communication line and connections.  |
| RS232 Tx                | Green | Indicates the state of the RS232 Tx line. LED is active when transceiving data. If there is no light when transmission is expected, check error messages. Check also system boards in rack.   |
| +5VDC / +12VDC / -12VDC | Green | Indicates that supply voltage is present and at correct level. If there is no light, check that voltage is present on power unit and that power is present in power connector. If not, check cables and connectors. If power is applied to the unit but it does not work, replace the unit. |

#### General LEDs

The significance of the LEDs are specified in section [DeviceNet Bus and I/O board status LED description on page 55](#).

*Continues on next page*

Input map

The figure below shows the analog input mapping.

**Note!** Pay attention to the order of the bits for the analog signals.

| Input byte | Bit  |   |   |   |   |   |   |   | Bit range |
|------------|------|---|---|---|---|---|---|---|-----------|
|            | 7    | 6 | 5 | 4 | 3 | 2 | 1 | 0 |           |
| 0          | LSB  |   |   |   |   |   |   |   | 0-15      |
| 1          | AI 1 |   |   |   |   |   |   |   |           |
|            | MSB  |   |   |   |   |   |   |   |           |
| 2          | LSB  |   |   |   |   |   |   |   | 16-31     |
| 3          | AI 2 |   |   |   |   |   |   |   |           |
|            | MSB  |   |   |   |   |   |   |   |           |
| 4          | LSB  |   |   |   |   |   |   |   | 32-47     |
| 5          | AI 3 |   |   |   |   |   |   |   |           |
|            | MSB  |   |   |   |   |   |   |   |           |
| 6          | LSB  |   |   |   |   |   |   |   | 48-63     |
| 7          | AI 4 |   |   |   |   |   |   |   |           |
|            | MSB  |   |   |   |   |   |   |   |           |

en040000806

|     |   |
|-----|---|
| LSB | The <i>least</i> significant bit of the binary number representing the analog signal. |
| MSB | The <i>most</i> significant bit of the binary number representing the analog signal.  |

Continues on next page

## 5 Boards and units

### 5.2.5. DSQC 355A, Analog I/O

*Continued*

#### Output map

The figure below shows the analog output mapping.

**Note!** Pay attention to the order of the bits for the analog signals.

| Output byte | Bit  |   |   |   |   |   |   |   | Bit range |       |
|-------------|------|---|---|---|---|---|---|---|-----------|-------|
|             | 7    | 6 | 5 | 4 | 3 | 2 | 1 | 0 |           |       |
| 0           | AO 1 |   |   |   |   |   |   |   | LSB       | 0-15  |
| 1           |      |   |   |   |   |   |   |   |           |       |
| 2           | AO 2 |   |   |   |   |   |   |   | LSB       | 16-31 |
| 3           |      |   |   |   |   |   |   |   |           |       |
| 4           | AO 3 |   |   |   |   |   |   |   | LSB       | 32-47 |
| 5           |      |   |   |   |   |   |   |   |           |       |
| 6           | AO 4 |   |   |   |   |   |   |   | LSB       | 48-63 |
| 7           |      |   |   |   |   |   |   |   |           |       |

en040000805

|     |   |
|-----|---|
| LSB | The <i>least</i> significant bit of the binary number representing the analog signal. |
| MSB | The <i>most</i> significant bit of the binary number representing the analog signal.  |

*Continues on next page*

#### Numerical format

The numerical representation of the values are described in the table below:

| Signal      | Analog physical value | Hexadecimal number | Bit value          |
|-------------|-----------------------|--------------------|--------------------|
| AO 1 - AO 3 | +10 V                 | 0x7FFF             | MaxBitVal = 32767  |
|             | 0 V                   | 0x0                |                    |
|             | -10 V                 | 0x800              | MinBitVal = -32768 |
| AO 4        | 20 mA                 | 0xFFFF             | MaxBitVal = 65535  |
|             | 4 mA                  | 0x0                | MinBitVal = 0      |
| AI 1 - AI 4 | +10 V                 | 0x7FFF             | MaxBitVal = 32767  |
|             | 0 V                   | 0x0                |                    |
|             | -10 V                 | 0x8000             | MinBitVal = -32768 |

#### Additional information

The table shows the physical type of the signals, resolution etc.

| Signal | Type    | Range          | Resolution | Encoding type   |
|--------|---------|----------------|------------|-----------------|
| AO 1   | Voltage | -10 V .. +10 V | 12 bit     | Twos complement |
| AO 2   | Voltage | -10 V .. +10 V | 12 bit     | Twos complement |
| AO 3   | Voltage | -10 V .. +10 V | 12 bit     | Twos complement |
| AO 4   | Current | 4 mA .. 20 mA  | 12 bit     | Unsigned        |
| AI 1   | Voltage | -10 V .. +10 V | 16 bit     | Twos complement |
| AI 2   | Voltage | -10 V .. +10 V | 16 bit     | Twos complement |
| AI 3   | Voltage | -10 V .. +10 V | 16 bit     | Twos complement |
| AI 4   | Voltage | -10 V .. +10 V | 16 bit     | Twos complement |



## 5 Boards and units

### 5.2.6. DSQC 350A, DeviceNet/Allen Bradley remote I/O gateway

### 5.2.6. DSQC 350A, DeviceNet/Allen Bradley remote I/O gateway

#### Description

The DSQC 350A is a circuit board normally mounted in the control module. As an option, it may also be mounted in an external I/O module.

The unit handles input and output signals between the DeviceNet system and the Allen Bradley system.

#### Warranty

This product incorporates a communications link which is licensed under patents and proprietary technology of the Allen-Bradley Company, Inc. The Allen-Bradley Company, Inc. does not warrant or support this product. All warranty and support services for this product are the responsibility of and provided by ABB.

#### Termination

When the robot is last in a RIO loop, the loop must be terminated with a termination resistor according to *Allen-Bradley's specification*.

#### Illustration

The figure below shows the DSQC 350A board:

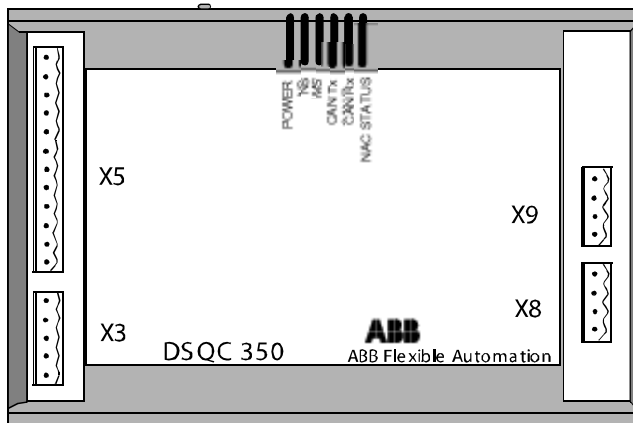

xx010000226

*Continues on next page*

#### Parts

The table below refers to the illustration in section [Illustration on page 100](#).

| Item | Description  |
|------|--|
| X3   | Back-up feed supply  |
| X5   | DeviceNet and ID connector   |
| X8   | RIO in<br>See section <a href="#">Connector X8 on page 103</a> for connection tables!  |
| X9   | RIO out<br>See section <a href="#">Connector X9 on page 103</a> for connection tables! |

#### Facts, DSQC 350A

This section specifies a number of facts applicable to the DSQC 350A. Unless stated otherwise, the data applies to the standard version.

#### Technical data

|                        |   |
|------------------------|---|
| No. of digital inputs  | Unit is programmable for 32, 64, 96 or 128 digital inputs.  |
| No. of digital outputs | Unit is programmable for 32, 64, 96 or 128 digital outputs.   |
| SW connections         | Support for the following connections: <ul style="list-style-type: none"> <li>• Polled</li> <li>• Change-Of-State</li> <li>• Change-Of-State with acknowledge suppression</li> </ul> For descriptions of the different types of I/O connections, see <a href="#">I/O messages - connection types on page 15</a> . |

*Continues on next page*

## 5 Boards and units

### 5.2.6. DSQC 350A, DeviceNet/Allen Bradley remote I/O gateway

*Continued*

#### Connector X3

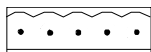

5 1

xx0100000221

The table below shows the connections to connector X3:

| Signal name | X3 pin | Function                |
|-------------|--------|-------------------------|
| 0 VDC       | 1      | Supply voltage GND      |
| NC          | 2      | Not connected           |
| GND         | 3      | Ground connection       |
| NC          | 4      | Not connected           |
| + 24 VDC    | 5      | Supply voltage + 24 VDC |

#### Connector X5



12 1

xx0100000244

Connector X5 is a DeviceNet connector specified in section [Setting DeviceNet bus ID on page 62](#).

*Continues on next page*

Connector X8

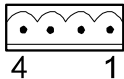

xx0400000718

The table below shows the connections to connector X8:

| Signal name    | X8 pin | Function      |
|----------------|--------|---------------|
| LINE1 (blue)   | 1      | Remote I/O in |
| LINE2 (clear)  | 2      | Remote I/O in |
| Shield         | 3      | Remote I/O in |
| Cabinet ground | 4      | Remote I/O in |

Connector X9

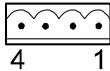

xx0400000718

The table below shows the connections to connector X9:

| Signal name    | X9 pin | Function       |
|----------------|--------|----------------|
| Blue           | 1      | Remote I/O out |
| Clear          | 2      | Remote I/O out |
| Shield         | 3      | Remote I/O out |
| Cabinet ground | 4      | Remote I/O out |

*Continues on next page*

## 5 Boards and units

### 5.2.6. DSQC 350A, DeviceNet/Allen Bradley remote I/O gateway

*Continued*

#### Board specific LEDs

The figure and table below show the location and significance of the the LEDs on the board.

| Designation  | Color | Description   |
|--------------|-------|---|
| POWER-24 VDC | Green | Indicates that a supply voltage is present, and has a level above 12 VDC.<br>If there is no light, check that voltage is present on power unit and in power connector. If not, check cables and connectors.<br>If power is applied to the unit but it does not work, replace the unit.  |
| NAC STATUS   | Green | Steady green indicates RIO link in operation.<br>If there is no light, check network, cables and connections. Also check that PLC is operational.<br>Flashing green indicates that communication is established, but the INIT_COMPLETE bit is not set in NA chip, or configuration, rack size etc. does not match configuration set in PLC.<br>If LED keeps flashing continuously, check setup. |

#### General LEDs

The significance of the LEDs are specified in section [DeviceNet Bus and I/O board status LED description on page 55](#).

#### Unit size

The table explains the unit size for the input and output units.

| Unit size       | Rack size | Number of bits | Number of bytes |
|-----------------|-----------|----------------|-----------------|
| 32+2 DI/32 DO   | 0         | 32             | 4               |
| 64+2 DI/64 DO   | 1         | 64             | 8               |
| 96+2 DI/96 DO   | 2         | 96             | 12              |
| 128+2 DI/128 DO | 3         | 128            | 16              |

*Continues on next page*

#### Input map

The figure below shows the digital input mapping.

| Input byte | Bit          |                |                |                |                |                |                |                | Bit range            |
|------------|--------------|----------------|----------------|----------------|----------------|----------------|----------------|----------------|----------------------|
|            | 7            | 6              | 5              | 4              | 3              | 2              | 1              | 0              |                      |
| 0          | DI<br>8      | DI<br>7        | DI<br>6        | DI<br>5        | DI<br>4        | DI<br>3        | DI<br>2        | DI<br>1        | 0-7                  |
| 1          | DI<br>16     | DI<br>15       | DI<br>14       | DI<br>13       | DI<br>12       | DI<br>11       | DI<br>10       | DI<br>9        | 8-15                 |
| ⋮          | ⋮            | ⋮              | ⋮              | ⋮              | ⋮              | ⋮              | ⋮              | ⋮              | Depends on rack size |
| (m*4)-1    | DI<br>(m*32) | DI<br>(m*32)-1 | DI<br>(m*32)-2 | DI<br>(m*32)-3 | DI<br>(m*32)-4 | DI<br>(m*32)-5 | DI<br>(m*32)-6 | DI<br>(m*32)-7 | Depends on RackSize  |
| (m*4)      | N.U.         | N.U.           | N.U.           | N.U.           | N.U.           | N.U.           | RIO Status     | RIO Comm       | Depends on RackSize  |

en0400000720

|            |   |
|------------|---|
| m          | The rack size (in 32 bit intervals) that the unit has been configured to, using the Fieldbus Command Type <i>RackSize</i> .   |
| RIO Status | The status of the remote I/O communication can be monitored using the signal <i>RIO Status</i> . When <i>RIO Status</i> is set it indicates that the unit is in data communication with the PLC/master controlling it (the NAC STATUS LED is steady green). |
| RIO Comm   | The status of the remote I/O communication can be monitored using the signal <i>RIO Comm</i> . When <i>RIO Comm</i> is set it indicates that the RIO communication is "partially up" (the NAC STATUS LED is flashing), i.e. the PLC is in programming mode. |
| N.U.       | Not used. The signal position is reserved for future use and shall not be used.   |

The RIO status signals are located at the first bits of the last byte of the input area. For example, if the *RackSize* is set to 1 (2 \* 32 bit) there are 8 bytes of input data (bit 0-63), and the signals *RIO Command* *RIO Status* are located at bit 64 and bit 65 respectively.

*Continues on next page*

## 5 Boards and units

### 5.2.6. DSQC 350A, DeviceNet/Allen Bradley remote I/O gateway

*Continued*

#### Output map

The figure below shows the digital output mapping.

| Output byte | Bit          |                |                |                |                |                |                |                | Bit range           |
|-------------|--------------|----------------|----------------|----------------|----------------|----------------|----------------|----------------|---------------------|
|             | 7            | 6              | 5              | 4              | 3              | 2              | 1              | 0              |                     |
| 0           | DO<br>8      | DO<br>7        | DO<br>6        | DO<br>5        | DO<br>4        | DO<br>3        | DO<br>2        | DO<br>1        | 0-7                 |
| 1           | DO<br>16     | DO<br>15       | DO<br>14       | DO<br>13       | DO<br>12       | DO<br>11       | DO<br>10       | DO<br>9        | 8-15                |
| .           | .            | .              | .              | .              | .              | .              | .              | .              | Depends on RackSize |
| .           | .            | .              | .              | .              | .              | .              | .              | .              |                     |
| (m*4)-1     | DO<br>(m*32) | DO<br>(m*32)-1 | DO<br>(m*32)-2 | DO<br>(m*32)-3 | DO<br>(m*32)-4 | DO<br>(m*32)-5 | DO<br>(m*32)-6 | DO<br>(m*32)-7 | Depends on RackSize |

en040000719

m

The rack size (in 32 bit intervals) that the unit has been configured to, using the Fieldbus Command Type `RackSize`.

*Continues on next page*

#### Fieldbus Command Types

Following table gives necessary data on the Fieldbus Command Types for DeviceNet communication.

| Fieldbus Command Type | Path (DeviceNet parameter)        | Allowed values   | Usage   |
|-----------------------|-----------------------------------|--|---|
| LinkAddr              | 6, 20 64 24<br>01 30 01, C6,<br>1 | 0-63   | Determines the address of the DSQC 350A on the RIO connection.<br><b>Note!</b> The rack address is entered in decimal form (0-63) while AllenBradley use octal representation (base 8, range 0-77). |
| DataRate              | 6, 20 64 24<br>01 30 02, C6,<br>1 | 0-2 according to:<br>0 = 57.6 kbaud<br>1 = 115.2 kbaud<br>2 = 230.4 kbaud  | Determines the communication speed on the RIO bus.  |
| StartQ                | 6, 20 64 24<br>01 30 03, C6,<br>1 | 0-3 according to:<br>0 = First (PLC value 0)<br>1 = Second (PLC value 2)<br>2 = Third (PLC value 4)<br>3 = Fourth (PLC value 6)                          | Determines the RIO Starting Quarter of the unit.  |
| RackSize              | 6, 20 64 24<br>01 30 04, C6,<br>1 | 0-3 according to:<br>0 = 1/4 rack (32 DO, 32+2 DI)<br>1 = 1/2 rack (64 DO, 64+2 DI)<br>2 = 3/4 rack (96 DO, 96+2 DI)<br>3 = Full rack (128 DO, 128+2 DI) | Determines the size of the input and output data areas of the RIO gateway.  |
| LastRack              | 6, 20 64 24<br>01 30 05, C6,<br>1 | 0 and 1 according to:<br>0 = No (this is NOT the last rack)<br>1 = Yes (this is the last rack)   | Determines if the unit is the last rack on the RIO bus.   |

*Continues on next page*



## 5 Boards and units

---

### 5.2.6. DSQC 350A, DeviceNet/Allen Bradley remote I/O gateway

*Continued*

#### Additional information

The data areas of the gateway are "byte-consistent", which means that signals within the same byte (groups of 8 bits) are handled as one piece and are guaranteed to belong to the same bus-cycle. Normally this does not cause any problems, but if a signal group has been defined across the byte boundaries as e.g. a 16 bit group signal this needs to be considered. It is important to make sure that undesired behaviours are avoided in the case when the group signal is updated at exactly the same time as the gateway is being polled/scanned by one of the masters.

The values for the Fieldbus Command Types are stored in flash memory of the gateway module. Any change of these values requires a reset (or power cycle) of the gateway module before it actually assumes these new values. By using the standard configuration files for the gateways, the robot controller will automatically issue a reset command to activate the modified configuration.

### 5.2.7. DSQC 351A, DeviceNet/INTERBUS gateway

#### Description

The DSQC 351A is a circuit board normally mounted in the control module. As an option, it may also be mounted in an external I/O unit.

The unit handles input and output signals between the DeviceNet system and the INTERBUS system.

#### Communication concept

The INTERBUS system is able to communicate with a number of external devices, depending on the number of process words occupied by each unit. The robot controller may be equipped with several DSQC 351A boards. The INTERBUS inputs and outputs are accessible in the robot controller as general inputs and outputs.

Following figure is an outline diagram of the communication concept:

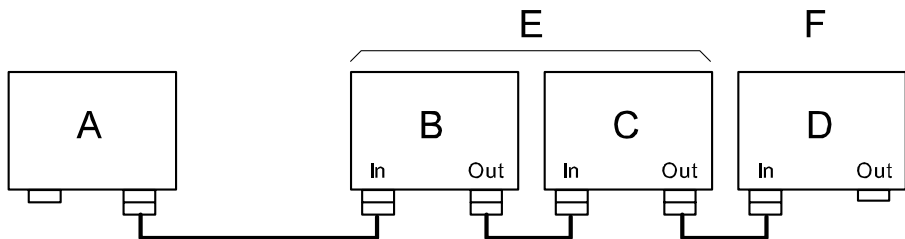

xx0100000224

|   |                                 |
|---|---------------------------------|
| A | Master PLC (customer equipment) |
| B | Robot 1 controller, word 1-4    |
| C | Robot 2 controller, word 5-8    |
| D | Robot 3 controller, word 9-12   |
| E | 128 inputs/128 outputs          |
| F | 64 inputs/64 outputs            |

**Note!** A link is connected between pin 5 and 9 in the plug on the interconnection cable connected to the OUT connector (connector X21) of each unit. The link informs the INTERBUS unit that more units are connected further out in the chain. (The last unit does not have a cable connected and therefore no link.)

*Continues on next page*

## 5 Boards and units

### 5.2.7. DSQC 351A, DeviceNet/INTERBUS gateway

*Continued*

#### Illustration of DSQC 351A

The illustration below shows the DSQC 351A board:

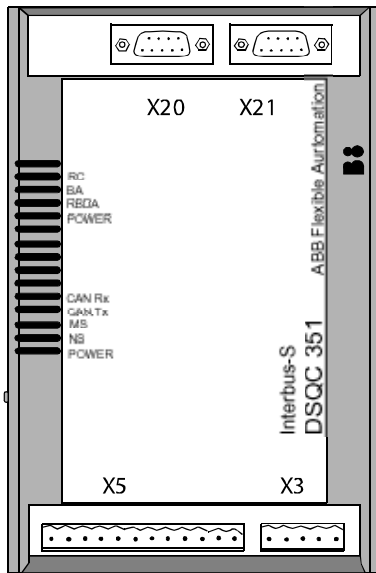

xx0100000225

#### Parts

The table below refers to *Illustration of DSQC 351A on page 110*.

| Item | Description  |
|------|--|
| X3   | Back-up feed supply<br>See section <a href="#">Connector X3 on page 112</a> for connection tables! |
| X5   | DeviceNet connector<br>See section <a href="#">Connector X5 on page 112</a> !                      |
| X20  | INTERBUS, input<br>See section <a href="#">Connector X20 on page 113</a> for connection tables!    |
| X21  | INTERBUS, output<br>See section <a href="#">Connector X21 on page 114</a> for connection tables!   |

*Continues on next page*

**Facts, DSQC 351A**

This section specifies a number of facts applicable to the DSQC 351A. Unless stated otherwise, the data applies to the standard version.

Also see the *INTERBUS specification*, International Standard DIN 19258.

Technical data

|                |   |
|----------------|---|
| SW connections | Support for the following connections: <ul style="list-style-type: none"><li>• Polled</li><li>• Change-Of-State</li><li>• Change-Of-State with acknowledge suppression</li></ul> For descriptions of the different types of I/O connections, see <a href="#">I/O messages - connection types on page 15</a> . |
|----------------|---|

Supply

The INTERBUS gateway must be fed externally to avoid shutting down the INTERBUS net if a robot cell is switched off. The 24V power supply must be fed from an external power source and be connected to connector X3.

INTERBUS master setup

The unit must be given an ID address, and setup parameters must be entered into the INTERBUS master system.

The unit ID to be entered in the INTERBUS master is 3. The length code depends on the selected data. The width is between 1 and 4 configured by the Fieldbus Command Type, DataWidth.

Continues on next page

## 5 Boards and units

### 5.2.7. DSQC 351A, DeviceNet/INTERBUS gateway

*Continued*

#### Connector X3

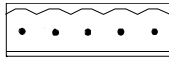

5 1

xx0100000221

The table below shows the connections to connector X3:

| Signal name | X3 pin | Function                |
|-------------|--------|-------------------------|
| 0 VDC       | 1      | Supply voltage GND      |
| NC          | 2      | Not connected           |
| GND         | 3      | Ground connection       |
| NC          | 4      | Not connected           |
| + 24 VDC    | 5      | Supply voltage + 24 VDC |

#### Connector X5

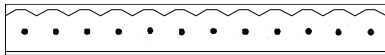

12 1

xx0100000244

Connector X5 is a DeviceNet connector specified in section [Setting DeviceNet bus ID on page 62](#).

*Continues on next page*

#### Connector X20

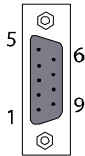

xx0100000220

The table below shows the connections to connector X20:

| Signal name | X20 pin | Function                   |
|-------------|---------|----------------------------|
| TPDO1       | 1       | Communication line TPDO1   |
| TPDI1       | 2       | Communication line TPDI1   |
| GND         | 3       | Ground connection          |
| NC          | 4       | Not connected              |
| NC          | 5       | Not connected              |
| TPDO1-N     | 6       | Communication line TPDO1-N |
| TPDI1-N     | 7       | Communication line TPDI1-N |
| NC          | 8       | Not connected              |
| NC          | 9       | Not connected              |

*Continues on next page*

## 5 Boards and units

### 5.2.7. DSQC 351A, DeviceNet/INTERBUS gateway

*Continued*

#### Connector X21

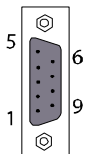

xx0100000220

The table below shows the connections to connector X21:

| Signal name | X21 pin | Function                   |
|-------------|---------|----------------------------|
| TPDO2       | 1       | Communication line TPDO2   |
| TPDI2       | 2       | Communication line TPDI2   |
| GND         | 3       | Ground connection          |
| NC          | 4       | Not connected              |
| + 5 V       | 5       | + 5 VDC                    |
| TPDO2-N     | 6       | Communication line TPDO2-N |
| TPDI2-N     | 7       | Communication line TPDI2-N |
| NC          | 8       | Not connected              |
| RBST        | 9       | Synchronization            |

**Note!** Pin 5 and pin 9 in X21 must be linked together.

*Continues on next page*

#### Board specific LEDs

The designations refer to LEDs shown in the figure in section *Illustration of DSQC 351A on page 110*.

| Designation                       | Color | Description  |
|-----------------------------------|-------|--|
| POWER-24 VDC<br>(upper indicator) | GREEN | Indicates that a supply voltage is present, and has a level above 12 VDC.<br>If there is no light, check that voltage is present on power module. Check also that power is present in power connector. If it is not, check cables and connectors.<br>If power is applied to unit but unit does not work, replace unit. |
| POWER- 5 VDC<br>(lower indicator) | GREEN | Lit when both 5 VDC supplies are within limits, and no reset is active.<br>If there is no light, check that voltage is present on power module. Check also that power is present in power connector. If it is not, check cables and connectors.<br>If power is applied to unit but unit does not work, replace unit.   |
| RBDA                              | RED   | Lit when this INTERBUS station is last in the INTERBUS network. If it is not, verify the INTERBUS configuration.   |
| BA                                | GREEN | Lit when INTERBUS is active.<br>If there is no light, check network, nodes and connections.  |
| RC                                | GREEN | Lit when INTERBUS communication runs without errors.<br>If there is no light, check system messages in robot and in INTERBUS net.  |

#### General LEDs

The significance of the LEDs are specified in section *DeviceNet Bus and I/O board status LED description on page 55*.



## 5 Boards and units

### 5.2.7. DSQC 351A, DeviceNet/INTERBUS gateway

*Continued*

#### Input map

The figure below shows the digital input mapping.

| Input byte | Bit                |                |                |                |                |                |                |                | Bit range               |
|------------|--------------------|----------------|----------------|----------------|----------------|----------------|----------------|----------------|-------------------------|
|            | 7                  | 6              | 5              | 4              | 3              | 2              | 1              | 0              |                         |
| 0          | DI<br>8            | DI<br>7        | DI<br>6        | DI<br>5        | DI<br>4        | DI<br>3        | DI<br>2        | DI<br>1        | 0-7                     |
| 1          | DI<br>16           | DI<br>15       | DI<br>14       | DI<br>13       | DI<br>12       | DI<br>11       | DI<br>10       | DI<br>9        | 8-15                    |
| .          | .                  | .              | .              | .              | .              | .              | .              | .              | Depends on<br>DataWidth |
| .          | .                  | .              | .              | .              | .              | .              | .              | .              |                         |
| .          | .                  | .              | .              | .              | .              | .              | .              | .              |                         |
| (m*2)-1    | DI<br>(m*16)       | DI<br>(m*16)-1 | DI<br>(m*16)-2 | DI<br>(m*16)-3 | DI<br>(m*16)-4 | DI<br>(m*16)-5 | DI<br>(m*16)-6 | DI<br>(m*16)-7 | Depends on<br>DataWidth |
| (m*2)      | Interbus<br>Status | N.U.           | N.U.           | N.U.           | N.U.           | N.U.           | N.U.           | N.U.           | Depends on<br>DataWidth |

en040000799

|                 |  |
|-----------------|--|
| m               | The number of words (16 bit) that the unit has been configured to, using the Fieldbus Command Type <code>DataWidth</code> .  |
| INTERBUS Status | The status of the INTERBUS communication can be monitored using the signal <i>INTERBUS Status</i> . When <i>INTERBUS Status</i> is set it indicates that the unit is in data communication with the PLC/master controlling it, i.e. bus is active (the BA LED is lit). |
| N.U.            | Not used. The signal position is reserved for future use and shall not be used.  |

The *INTERBUS Status* signal is located in the last bit of the last byte of the input area. For example, if the `DataWidth` is set to 4 (words) there are 8 bytes of input data (bit 0-63), and the *INTERBUS Status* is located in the last bit of the 9th byte i.e. bit 71.

*Continues on next page*

#### Output map

The figure below shows the digital output mapping.

| Output byte | Bit          |                |                |                |                |                |                |                | Bit range               |
|-------------|--------------|----------------|----------------|----------------|----------------|----------------|----------------|----------------|-------------------------|
|             | 7            | 6              | 5              | 4              | 3              | 2              | 1              | 0              |                         |
| 0           | DO<br>8      | DO<br>7        | DO<br>6        | DO<br>5        | DO<br>4        | DO<br>3        | DO<br>2        | DO<br>1        | 0-7                     |
| 1           | DO<br>16     | DO<br>15       | DO<br>14       | DO<br>13       | DO<br>12       | DO<br>11       | DO<br>10       | DO<br>9        | 8-15                    |
| ⋮           | ⋮            | ⋮              | ⋮              | ⋮              | ⋮              | ⋮              | ⋮              | ⋮              | Depends on<br>DataWidth |
| (m*2)-1     | DO<br>(m*16) | DO<br>(m*16)-1 | DO<br>(m*16)-2 | DO<br>(m*16)-3 | DO<br>(m*16)-4 | DO<br>(m*16)-5 | DO<br>(m*16)-6 | DO<br>(m*16)-7 | Depends on<br>DataWidth |

en040000800

|   |   |
|---|---|
| m | The number of words (16 bit) that the unit has been configured to, using the Fieldbus Command Type <code>DataWidth</code> . |
|---|---|

#### Fieldbus Command Types

Following table gives necessary data on the Fieldbus Command Types for DeviceNet communication.

| Fieldbus Command Type | Path (DeviceNet parameter)     | Allowed values   | Usage   |
|-----------------------|--------------------------------|--|---|
| DataWidth             | 6, 20 65 24 01<br>30 01, C6, 1 | 0-3 according to:<br>0 = 1 word (16 DO, 16+1 DI)<br>1 = 2 word (32 DO, 32+1 DI)<br>2 = 3 word (48 DO, 48+1 DI)<br>3 = 4 words (64 DO, 64+1 DI) | Determines the size of the input and output data areas of the INTERBUS gateway. |

*Continues on next page*

## 5 Boards and units

---

### 5.2.7. DSQC 351A, DeviceNet/INTERBUS gateway

*Continued*

#### Additional information

The data areas of the gateway are "byte-consistent", which means that signals within the same byte (groups of 8 bits) are handled as one piece and are guaranteed to belong to the same bus-cycle. Normally this does not cause any problems, but if a signal group has been defined across the byte boundaries as e.g. a 16 bit group signal this needs to be considered. It is important to make sure that undesired behaviours are avoided in the case when the group signal is updated at exactly the same time as the gateway is being polled/scanned by one of the masters.

The values for the Fieldbus Command Types are stored in flash memory of the gateway module. Any change of these values requires a reset (or power cycle) of the gateway module before it actually assumes these new values. By using the standard configuration files for the gateways, the robot controller will automatically issue a reset command to activate the modified configuration.

5.2.8. DSQC 352A, DeviceNet/PROFIBUS-DP gateway

Description

The DSQC 352A is a circuit board normally mounted in the control module. As an option, it may also be mounted in an external I/O unit.

The unit handles input and output signals between the DeviceNet system and the PROFIBUS-DP system.

Communication concept

The PROFIBUS-DP system is able to communicate with a number of external devices, depending on the number of process words occupied by each unit. The robot controller may be equipped with several DSQC 352A boards. The PROFIBUS-DP inputs and outputs are accessible in the robot controller as general inputs and outputs.

Following figure is an outline diagram of the communication concept:

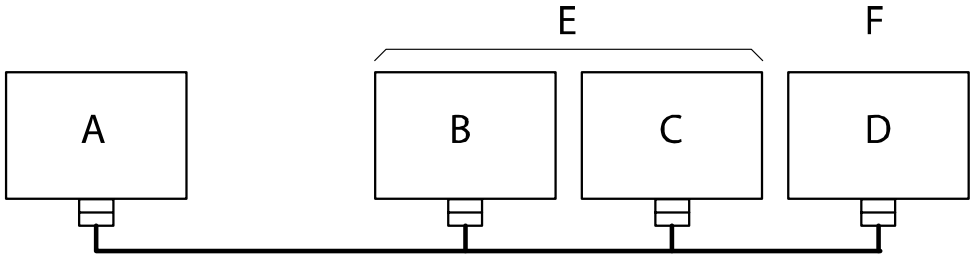

xx0100000222

|   |                                 |
|---|---------------------------------|
| A | Master PLC (customer equipment) |
| B | Robot 1 controller, word 1-8    |
| C | Robot 1 controller, word 9-16   |
| D | Robot 2 controller, word 17-24  |
| E | 256 inputs/256 outputs          |
| F | 128 inputs/128 outputs          |

**Note!** The PROFIBUS cable must be terminated in both ends.

*Continues on next page*

## 5 Boards and units

### 5.2.8. DSQC 352A, DeviceNet/PROFIBUS-DP gateway

*Continued*

#### Illustration

The figure below shows the DSQC 352A board:

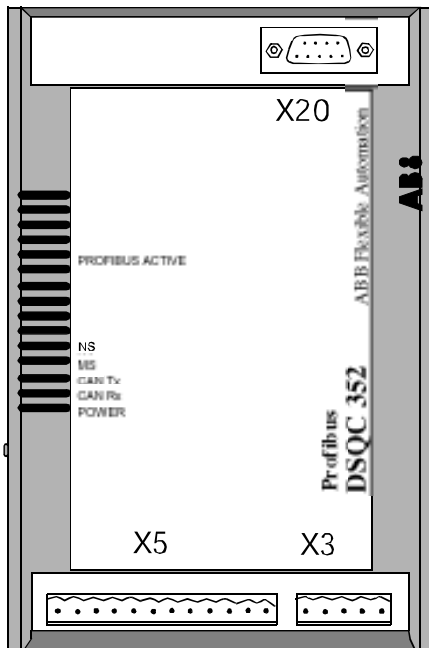

xx0100000223

#### Parts

The table below refers to the illustration in section *Illustration on page 120*.

| Item | Description   |
|------|---|
| X3   | Back-up feed supply<br>See section <a href="#">Connector X3 on page 121</a> for connection tables!  |
| X5   | DeviceNet connector<br>See section <a href="#">Connector X5 on page 122</a> !                       |
| X20  | PROFIBUS connection<br>See section <a href="#">Connector X20 on page 122</a> for connection tables! |

*Continues on next page*

#### Facts, DSQC 352A

This section specifies a number of facts applicable to the DSQC 352A. Unless stated otherwise, the data applies to the standard version.

Also see the [PROFIBUS-DP specification](#), International Standard DIN E 19245 part 3.

#### Technical data

|                |   |
|----------------|---|
| SW connections | Support for the following connections: <ul style="list-style-type: none"> <li>• Polled</li> <li>• Change-Of-State</li> <li>• Change-Of-State with acknowledge suppression</li> </ul> For descriptions of the different types of I/O connections, see <a href="#">I/O messages - connection types on page 15</a> . |
|----------------|---|

#### Supply

The PROFIBUS-DP does not need any external power feed, power is supplied via X5.

All the robots cells are connected to the trunk cable via a special D-sub connector which works as a very short drop cable. Because of this, the PROFIBUS will work correctly even if a robot cell is turned off.

#### Unit ID and setup

The unit must be given an ID address, and setup parameters must be entered into the system.

#### Connector X3

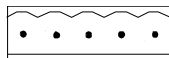

5 1

xx0100000221

The table below shows the connections to connector X3:

| Signal name | X3 pin | Function           |
|-------------|--------|--------------------|
| 0 VDC       | 1      | Supply voltage GND |
| NC          | 2      | Not connected      |
| GND         | 3      | Ground connection  |

*Continues on next page*

## 5 Boards and units

### 5.2.8. DSQC 352A, DeviceNet/PROFIBUS-DP gateway

*Continued*

| Signal name | X3 pin | Function                |
|-------------|--------|-------------------------|
| NC          | 4      | Not connected           |
| + 24 VDC    | 5      | Supply voltage + 24 VDC |

#### Connector X5

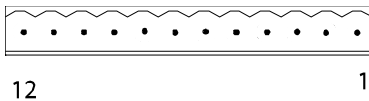

xx0100000244

Connector X5 is a DeviceNet connector further described in section [Setting DeviceNet bus ID on page 62](#).

#### Connector X20

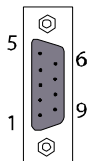

xx0100000220

The table below shows the connections to connector X20:

| Signal name | X20 pin | Function                |
|-------------|---------|-------------------------|
| Shield      | 1       | Cable screen            |
| NC          | 2       | Not connected           |
| RxD/TxD-P   | 3       | Receive/Transmit data P |
| Control-P   | 4       |                         |
| GND         | 5       | Ground connection       |
| +5 VDC      | 6       |                         |
| NC          | 7       | Not connected           |
| RxD/TxD-N   | 8       | Receive/Transmit data N |
| NC          | 9       | Not connected           |

*Continues on next page*

#### Board specific LEDs

The designations refer to LEDs shown in the figure in section [Illustration on page 120](#).

| Designation     | Color | Description  |
|-----------------|-------|--|
| PROFIBUS active | Green | Lit when the node is communicating with the master.<br>If there is no light, check system messages in robot and in PROFIBUS net.   |
| POWER, 24 VDC   | Green | Indicates that a supply voltage is present, and has a level above 12 VDC.<br>If there is no light, check that voltage is present in power unit and in the power connector. If not, check cables and connectors.<br>If power is applied to the unit but it does not work, replace the unit. |

#### General LEDs

The significance of the LEDs are specified in section [DeviceNet Bus and I/O board status LED description on page 55](#).



## 5 Boards and units

### 5.2.8. DSQC 352A, DeviceNet/PROFIBUS-DP gateway

*Continued*

#### Input map

The figure below shows the digital input mapping.

| Input byte | Bit                |                |                |                |                |                |                |                | Bit range                          |
|------------|--------------------|----------------|----------------|----------------|----------------|----------------|----------------|----------------|------------------------------------|
|            | 7                  | 6              | 5              | 4              | 3              | 2              | 1              | 0              |                                    |
| 0          | DI<br>8            | DI<br>7        | DI<br>6        | DI<br>5        | DI<br>4        | DI<br>3        | DI<br>2        | DI<br>1        | 0-7                                |
| 1          | DI<br>16           | DI<br>15       | DI<br>14       | DI<br>13       | DI<br>12       | DI<br>11       | DI<br>10       | DI<br>9        | 8-15                               |
| .          | .                  | .              | .              | .              | .              | .              | .              | .              | Depends on<br>MasterInput-<br>Size |
| (m*2)-1    | DI<br>(m*16)       | DI<br>(m*16)-1 | DI<br>(m*16)-2 | DI<br>(m*16)-3 | DI<br>(m*16)-4 | DI<br>(m*16)-5 | DI<br>(m*16)-6 | DI<br>(m*16)-7 | Depends on<br>MasterInput-<br>Size |
| (m*2)      | Profibus<br>Status | N.U.           | N.U.           | N.U.           | N.U.           | N.U.           | N.U.           | N.U.           | Depends on<br>MasterInput-<br>Size |

en040000804

|                 |   |
|-----------------|---|
| m               | The number of words (16 bit) that the unit has been configured to, using the Fieldbus Command Type <code>MasterInputSize</code> .   |
| PROFIBUS Status | The status of the PROFIBUS communication can be monitored using the signal <i>PROFIBUS Status</i> . When <i>PROFIBUS Status</i> is set it indicate that the unit is in data communication with the PLC/master controlling it. |
| N.U.            | Not used. The signal position is reserved for future use and shall not be used.   |

The *PROFIBUS Status* signal is located in the last bit of the last byte of the input area. For example, if the `MasterInputSize` is set to 4 (words) there are 8 bytes of input data (bit 0-63), and the *PROFIBUS Status* is located in the last bit of the 9th byte i.e. bit 71.

*Continues on next page*

Output map

The figure below shows the digital output mapping.

| Output byte | Bit          |                |                |                |                |                |                |                | Bit range                           |
|-------------|--------------|----------------|----------------|----------------|----------------|----------------|----------------|----------------|-------------------------------------|
|             | 7            | 6              | 5              | 4              | 3              | 2              | 1              | 0              |                                     |
| 0           | DO<br>8      | DO<br>7        | DO<br>6        | DO<br>5        | DO<br>4        | DO<br>3        | DO<br>2        | DO<br>1        | 0-7                                 |
| 1           | DO<br>16     | DO<br>15       | DO<br>14       | DO<br>13       | DO<br>12       | DO<br>11       | DO<br>10       | DO<br>9        | 8-15                                |
| .           | .            | .              | .              | .              | .              | .              | .              | .              | Depends on<br>MasterOutput-<br>Size |
| .           | .            | .              | .              | .              | .              | .              | .              | .              |                                     |
| .           | .            | .              | .              | .              | .              | .              | .              | .              |                                     |
| (m*2)-1     | DO<br>(m*16) | DO<br>(m*16)-1 | DO<br>(m*16)-2 | DO<br>(m*16)-3 | DO<br>(m*16)-4 | DO<br>(m*16)-5 | DO<br>(m*16)-6 | DO<br>(m*16)-7 | Depends on<br>MasterOutput-<br>Size |

en0400000912

|   |  |
|---|--|
| m | The number of words (16 bit) that the unit has been configured to, using the Fieldbus Command Type MasterOutputSize. |
|---|--|

*Continues on next page*

## 5 Boards and units

### 5.2.8. DSQC 352A, DeviceNet/PROFIBUS-DP gateway

*Continued*

#### Fieldbus Command Types

Following table gives necessary data on the Fieldbus Command Types for DeviceNet communication.

| Fieldbus Command Type | Path (DeviceNet parameter)     | Allowed values | Usage  |
|-----------------------|--------------------------------|----------------|--|
| MasterInputSize       | 6, 20 67 24 01<br>30 02, C6, 1 | 0-8 (words)    | Determines the size of the input data area of the gateway module.<br>The size is expressed in number of words (16 bit groups), which means that the maximum size of input data for one DSQC 352A is 128 bit.<br>By reducing the size, the allocated bandwidth decreases and thus the throughput and performance of the network increase.   |
| MasterOutputSize      | 6, 20 67 24 01<br>30 03, C6, 1 | 0-8 (words)    | Determines the size of the output data area of the gateway module.<br>The size is expressed in number of words (16 bit groups), which means that the maximum size of output data for one DSQC 352A is 128 bit.<br>By reducing the size, the allocated bandwidth decreases and thus the throughput and performance of the network increase. |
| StationAddress        | 6, 20 67 24 01<br>30 04, C6, 1 | 2-126          | Determines the address of the DSQC 352A on the PROFIBUS connection.<br>The value that <code>StationAddress</code> is set to, is the gateway address found by the external master (PLC) connected to the PROFIBUS side of the gateway.  |

*Continues on next page*

#### Additional information

The data areas of the gateway are "byte-consistent", which means that signals within the same byte (groups of 8 bits) are handled as one piece and are guaranteed to belong to the same bus-cycle. Normally this does not cause any problems, but if a signal group has been defined accross the byte boundaries as e.g. a 16 bit group signal this needs to be considered. It is important to make sure that undesired behaviours are avoided in the case when the group signal is updated at exactly the same time as the gateway is beeing polled/scanned by one of the masters.

The values for the Fieldbus Command Types are stored in flash memory of the gateway module. Any change of these values requires a reset (or power cycle) of the gateway module before it actually assumes these new values. By using the standard configuration files for the gateways, the robot controller will automatically issue a reset command to activate the modified configuration.

To configure an external PROFIBUS master (PLC) to communicate with the gateway, a GSD-file is required. The GSD-file for the DSQC 352A is found on the RobotWare CD-ROM in following directory:

```
<CD-drive>:\Utility\fieldbus\PROFIBUS\gsd\abb_0600.gsd
```

## 5 Boards and units

### 5.2.9. DSQC 378A, DeviceNet/CCLink gateway

#### 5.2.9. DSQC 378A, DeviceNet/CCLink gateway

##### Description

The DSQC 378A unit offers an interface between the CCLink bus and the DeviceNet bus as used on the robot system. The unit is regarded as an *intelligent device* by the CCLink PLC.

##### Communication concept

The CCLink can communicate with a number of external devices, depending on the number of stations occupied by each unit. There is a maximum of 64 stations, each capable of up to 32 I/O points and 8 points word data. The units are setup to have between 1 and 4 occupied stations each. The CCLink unit is connected to the CCLink PLC by a twisted pair cable with shield.

The CCLink inputs and outputs are accessible in the robot controller as general inputs and outputs.

Following figure is an outline diagram of the communication concept:

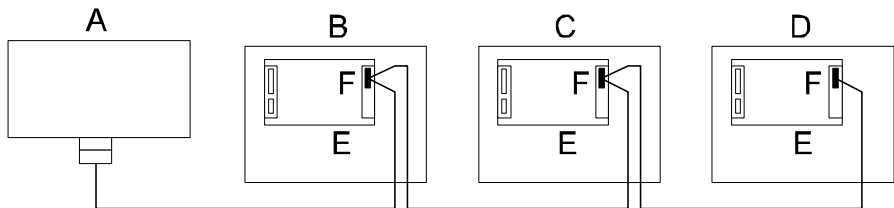

xx040000826

|   |                                 |
|---|---------------------------------|
| A | Master PLC (customer equipment) |
| B | Robot 1 controller              |
| C | Robot 2 controller              |
| D | Robot 3 controller              |
| E | DSQC 378A controller            |
| F | Connector X8 controller         |

**Note!** The CCLink cable must be terminated with termination resistors (110 ohm) in both ends.

*Continues on next page*

**Illustration of DSQC 378A**

The figure below shows the DSQC 378A board:

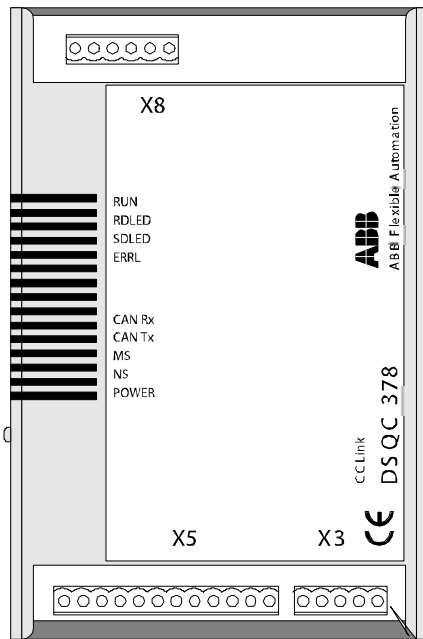

xx0400000825

**Parts**

| Item | Description   |
|------|---|
| X3   | Back-up feed supply<br>See section <a href="#">Connector X3 on page 130</a> for connection tables!      |
| X5   | DeviceNet connector<br>See section <a href="#">Connector X5 on page 131!</a>                            |
| X8   | CCLink network connector<br>See section <a href="#">Connector X8 on page 131</a> for connection tables! |

*Continues on next page*

## 5 Boards and units

### 5.2.9. DSQC 378A, DeviceNet/CCLink gateway

*Continued*

#### Facts, DSQC 378A

This section specifies a number of facts applicable to the DSQC 378A. Unless stated otherwise, the data applies to the standard version.

#### Technical data

|                |   |
|----------------|---|
| SW connections | Support for the following connections: <ul style="list-style-type: none"><li>• Polled</li><li>• Change-Of-State</li><li>• Change-Of-State with acknowledge suppression</li></ul> For descriptions of the different types of I/O connections, see <a href="#">I/O messages - connection types on page 15</a> . |
|----------------|---|

#### Unit setup

The unit must be given an ID address, and setup parameters must be entered into the system.

#### Connector X3



5 1

xx0100000221

The table below shows the connections to connector X3:

| Signal name | X3 pin | Function               |
|-------------|--------|------------------------|
| 0 VDC       | 1      | Supply voltage GND     |
| NC          | 2      | Not connected          |
| GND         | 3      | Ground connection      |
| NC          | 4      | Not connected          |
| + 24 VDC    | 5      | Supply voltage +24 VDC |

*Continues on next page*

Connector X5

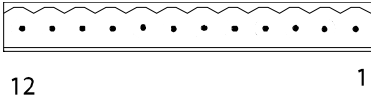

xx0100000244

Connector X5 is a DeviceNet connector specified in section *Setting DeviceNet bus ID on page 62*.

Connector X8

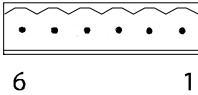

xx0200000265

The table below shows the connections to connector X8:

| Signal name | X8 pin | Function                               |
|-------------|--------|--|
| SLD         | 1      | Shield, connected to power GND/Housing |
| DA          | 2      | Signal line, A                         |
| DG          | 3      | Digital GND, connected to signal GND   |
| DB          | 4      | Signal line, B                         |
| NC          | 5      | Not connected                          |
| FG          | 6      | Power GND, same as SLD                 |

Continues on next page



## 5 Boards and units

### 5.2.9. DSQC 378A, DeviceNet/CCLink gateway

*Continued*

#### Board specific LEDs

The designations refer to LEDs shown in the figure in section *Illustration of DSQC 378A on page 129*.

| Designation          | Color | Description  |
|----------------------|-------|--|
| POWER-24 VDC         | Green | Indicates that a supply voltage is present, and has a level above 12 VDC.<br>If there is no light, check that voltage is present on power module. Check also that power is present in power connector. If it is not, check cables and connectors.<br>If power is applied to unit but unit does not work, replace unit.   |
| RUN (ON: H output)   |       | <b>ON:</b> Receive both refresh and polling signals or just the refresh signal normally, after joining the network.<br>See figure below this table.<br><b>OFF:</b> <ol style="list-style-type: none"><li>1. Before joining the network.</li><li>2. Unable to detect carriers neither for channel 1 or 2.</li><li>3. Time out.</li><li>4. Resetting hardware.</li></ol> |
| RDLED (ON: L output) |       | <b>ON:</b> Detecting the carrier for channel 1 or 2. Check cables and terminator.<br><b>OFF:</b> <ol style="list-style-type: none"><li>1. Unable to detect carriers neither for channel 1 or 2.</li><li>2. Resetting hardware.</li></ol>   |

*Continues on next page*

| Designation          | Color | Description   |
|----------------------|-------|---|
| SDLED (ON: L output) |       | <p><b>ON:</b> During transmission to During transmission + (0.41 ms * 2<sup>(n-1)</sup>)<br/>n = 1-8<br/>Check setup in both robot controller and PLC.</p> <p><b>OFF:</b></p> <ol style="list-style-type: none"> <li>1. Other than listed under ON.</li> <li>2. Resetting hardware.</li> </ol>  |
| ERRL (ON: L output)  |       | <p><b>ON:</b></p> <ol style="list-style-type: none"> <li>1. CRC error. Check setup in both robot controller and PLC.</li> <li>2. Switch setting error during cancellation of reset (0, 65, or greater is set including the number of occupied stations).</li> <li>3. Baud rate switch setting error during cancellation of reset (5 or greater).</li> </ol> <p><b>OFF:</b></p> <ol style="list-style-type: none"> <li>1. Normal communication.</li> <li>2. Resetting hardware.</li> </ol> <p><b>BLINKING:</b> The switch setting has been changed from the setting at the reset cancellation (blinks for 0.4 sec.).</p> |

## 5 Boards and units

### 5.2.9. DSQC 378A, DeviceNet/CCLink gateway

*Continued*

The following figure describes the LED sequences.

**Note!** Read the figure line by line. The Operation column describes the operation status depending on the status of the four LEDs.

○ = On      ◐ = Blinking      ● = Off

| ERRL         | SDLED | RDLED | RUN | Operation   |
|--------------|-------|-------|-----|---|
| ◐            | ◐     | ○     | ○   | Communicating normally, but CRC errors have often been detected due to noise.                     |
| ◐<br>0.4 sec | ◐     | ○     | ○   | The baud rate or station number setting has been changed from the settings at reset cancellation. |
| ◐            | ◐     | ●     | ○   | • (Impossible operation status.)  |
| ◐            | ●     | ○     | ○   | Unable to respond because the received data caused a CRC error.                                   |
| ◐            | ●     | ●     | ○   | • (Impossible operation status.)  |
| ●            | ◐     | ○     | ○   | Normal communication.   |
| ●            | ◐     | ●     | ○   | • (Impossible operation status.)  |
| ●            | ●     | ○     | ○   | No data for the host.   |
| ●            | ●     | ●     | ○   | • (Impossible operation status.)  |
| ◐            | ◐     | ○     | ●   | Responds to polling signal, but the refresh reception caused a CRC error.                         |
| ◐            | ◐     | ●     | ●   | • (Impossible operation status.)  |
| ◐            | ●     | ○     | ●   | Data for the host caused a CRC error.   |
| ◐            | ●     | ●     | ●   | • (Impossible operation status.)  |
| ●            | ◐     | ○     | ●   | • (Impossible operation status.)  |
| ●            | ◐     | ●     | ●   | • (Impossible operation status.)  |
| ●            | ●     | ○     | ●   | Either no data for the host or unable to receive the data for host due to noise.                  |
| ●            | ●     | ●     | ●   | Unable to receive due to wire breakage etc. Power off hardware being set.                         |
| ○            | ●     | ○/●   | ●   | Baud rate and/or station number setting error.  |

en0400000827

#### General LEDs

The significance of the LEDs are specified in section [DeviceNet Bus and I/O board status LED description on page 55](#).

*Continues on next page*

#### Input map

The figure below shows the digital input mapping.

| Input byte | Bit           |            |            |            |            |            |            |            | Bit range                      |
|------------|---------------|------------|------------|------------|------------|------------|------------|------------|--------------------------------|
|            | 7             | 6          | 5          | 4          | 3          | 2          | 1          | 0          |                                |
| 0          | DI 8          | DI 7       | DI 6       | DI 5       | DI 4       | DI 3       | DI 2       | DI 1       | 0-7                            |
| 1          | DI 16         | DI 15      | DI 14      | DI 13      | DI 12      | DI 11      | DI 10      | DI 9       | 8-15                           |
| .          | .             | .          | .          | .          | .          | .          | .          | .          | Depends on OccStat and BasicIO |
| .          | .             | .          | .          | .          | .          | .          | .          | .          |                                |
| .          | .             | .          | .          | .          | .          | .          | .          | .          |                                |
| m-1        | DI (m*8)      | DI (m*8)-1 | DI (m*8)-2 | DI (m*8)-3 | DI (m*8)-4 | DI (m*8)-5 | DI (m*8)-6 | DI (m*8)-7 | Depends on OccStat and BasicIO |
| m          | CCLink Status | N.U.       | N.U.       | N.U.       | N.U.       | N.U.       | N.U.       | N.U.       | Depends on OccStat and BasicIO |

en040000823

|               |  |
|---------------|--|
| m             | The size in bytes (8 bit) that the unit has been configured to, using the fieldbus Command Types <code>OccStat</code> and <code>BasicIO</code> . See table in section <a href="#">Fieldbus Command Types on page 136</a> |
| CCLink Status | The status of the CCLink communication can be monitored using the signal <code>CCLink Status</code> . When <code>CCLink Status</code> is set it indicates that the CCLink communication is O.K.                          |
| N.U.          | Not used. The signal position is reserved for future use and shall not be used.  |

The `CCLink Status` signal is located at the last bit of the last byte of the input area. For example, if `OccStat` is set to 2 and `BasicIO` is set to 0 there are 6 bytes of input data (bit 0-47), and the `CCLink Status` is located in the last bit of the 7th byte i.e. bit 55.

*Continues on next page*

## 5 Boards and units

### 5.2.9. DSQC 378A, DeviceNet/CCLink gateway

*Continued*

#### Output map

The figure below shows the digital output mapping.

| Output byte | Bit         |               |               |               |               |               |               |               | Bit range                       |
|-------------|-------------|---------------|---------------|---------------|---------------|---------------|---------------|---------------|---------------------------------|
|             | 7           | 6             | 5             | 4             | 3             | 2             | 1             | 0             |                                 |
| 0           | DO<br>8     | DO<br>7       | DO<br>6       | DO<br>5       | DO<br>4       | DO<br>3       | DO<br>2       | DO<br>1       | 0-7                             |
| 1           | DO<br>16    | DO<br>15      | DO<br>14      | DO<br>13      | DO<br>12      | DO<br>11      | DO<br>10      | DO<br>9       | 8-15                            |
| .           | .           | .             | .             | .             | .             | .             | .             | .             | Depends on OccStat and BasicIO  |
| .           | .           | .             | .             | .             | .             | .             | .             | .             |                                 |
| .           | .           | .             | .             | .             | .             | .             | .             | .             |                                 |
| m-1         | DO<br>(m*8) | DO<br>(m*8)-1 | DO<br>(m*8)-2 | DO<br>(m*8)-3 | DO<br>(m*8)-4 | DO<br>(m*8)-5 | DO<br>(m*8)-6 | DO<br>(m*8)-7 | Depends on OccStat and Basic IO |

en040000824

|   |  |
|---|--|
| m | The size in bytes (8 bit) that the unit has been configured to, using the Fieldbus Command Types <code>OccStat</code> and <code>BasicIO</code> . See table in section <a href="#">Fieldbus Command Types on page 136</a> . |
|---|--|

#### Fieldbus Command Types

Following table gives necessary data on the Fieldbus Command Types for DeviceNet communication.

| Fieldbus Command Type | Path (DeviceNet parameter)        | Allowed values   | Usage   |
|-----------------------|-----------------------------------|--|---|
| StationNo             | 6, 20 68 24<br>01 30 01, C6,<br>1 | 1-64   | Determines the address of the DSQC 378A on the CCLink connection. |
| BaudRate              | 6, 20 68 24<br>01 30 02, C6,<br>1 | 0-4 according to:<br>0 = 156 kbps<br>1 = 625 kbps<br>2 = 2.5 kbps<br>3 = 5 Mbps<br>4 = 10 Mbps | Determines the communication speed on the CCLink bus.             |

*Continues on next page*

| Fieldbus Command Type | Path (DeviceNet parameter)  | Allowed values   | Usage   |
|-----------------------|-----------------------------|--|---|
| OccStat               | 6, 20 68 24 01 30 03, C6, 1 | 1-4 according to:<br>1 = 1 occupied station<br>2 = 2 occupied stations<br>3 = 3 occupied stations<br>4 = 4 occupied stations | Occupied stations. Determines the size of the input and output data areas of the CCLink module. The size, expressed in bits and bytes, also depends on the value of BasicIO. See table in section <a href="#">Size of input/output data areas on page 137</a> .   |
| BasicIO               | 6, 20 68 24 01 30 04, C6, 1 | 0-1 according to:<br>0 = Bit I/O only<br>1 = Bit I/O and word I/O  | Determines the type of I/O data to be exchanged with the CCLink master. This also affects the size of the input and output data areas of the CCLink module. The size, expressed in bits and bytes, also depends on the value of OccStat. See table in section <a href="#">Size of input/output data areas on page 137</a> . |

#### Size of input/output data areas

The size of the input/output data areas expressed in bits and bytes are determined by the values of the Fieldbus Command Types OccStat and BasicIO according to following table:

| Value of OccStat | No. of bits when BasicIO = 0 | No. of bytes when BasicIO = 0 | No. of bits when BasicIO = 1 | No. of bytes when BasicIO = 1 |
|------------------|------------------------------|-------------------------------|------------------------------|-------------------------------|
| 1                | 16                           | 2                             | 80                           | 10                            |
| 2                | 48                           | 6                             | 176                          | 22                            |
| 3                | 80                           | 10                            | 272                          | 34                            |
| 4                | 112                          | 14                            | 368                          | 46                            |

*Continues on next page*

## 5 Boards and units

---

### 5.2.9. DSQC 378A, DeviceNet/CCLink gateway

*Continued*

#### Additional information

The data areas of the gateway are "byte-consistent", which means that signals within the same byte (group of 8 bits) are handled as one piece and are guaranteed to belong to the same bus-cycle. Normally this does not cause any problems, but if a signal group has been defined across the byte boundaries as e.g. a 16 bit group signal this needs to be considered. It is important to make sure that undesired behaviours are avoided in the case when the group signal is updated at exactly the same time as the gateway is being polled/scanned by one of the masters.

The values for the Fieldbus Command Types are stored in flash memory of the gateway module. Any change of these values requires a reset (or power cycle) of the gateway module before it actually assumes these new values. By using the standard configuration files for the gateways, the robot controller will automatically issue a reset command to activate the modified configuration.

#### 5.2.10. DSQC 377A, Queue tracking unit

---

##### Description

The encoder unit DSQC 377A provides connection for one encoder and one digital input (synchronization switch), and includes queue tracking functions.

##### Usage

The encoder unit is normally used for installation on a conveyor to enable the robot programs to synchronize to the motion (position) of the conveyor (conveyor tracking).

The digital input is used for synchronization switch (also called sync signal), which means conveyor synchronization point.

*Continues on next page*



## 5 Boards and units

### 5.2.10. DSQC 377A, Queue tracking unit

*Continued*

#### Illustration of DSQC 377A

The figure below shows the DSQC 377A board:

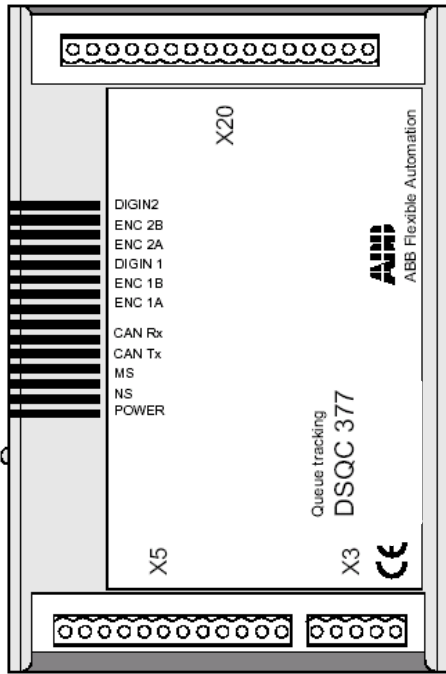

xx0400000751

#### Parts

| Item | Description   |
|------|---|
| X3   | Back-up feed supply<br>See section <a href="#">Connector X3 on page 143</a> for connection tables!  |
| X5   | DeviceNet connector<br>See section <a href="#">Connector X5 on page 143</a> !                       |
| X20  | Conveyor connection<br>See section <a href="#">Connector X20 on page 144</a> for connection tables! |

*Continues on next page*

---

#### Facts, DSQC 377A

This section specifies a number of facts applicable to the DSQC 377A. Unless stated otherwise, the data applies to the standard version.

#### Technical data

|                       |  |
|-----------------------|--|
| No. of encoder inputs | 1  |
| No. of digital inputs | 1 (24 VDC)   |
| Supply voltage        | 24 VDC   |
| Supply source         | 24 V I/O or external supply  |
| SW connections        | Support for the polled connection.<br>For descriptions of the different types of I/O connections, see <a href="#">I/O messages - connection types on page 15</a> . |

Also see *Product specification, IRC5 with FlexPendant*.

*Continues on next page*

## 5 Boards and units

### 5.2.10. DSQC 377A, Queue tracking unit

*Continued*

#### Encoder connections

The wiring diagram in the figure below shows how to connect the encoder and sync signal switch to the encoder unit. As can be seen from the illustration, the encoder is supplied with 24 VDC and 0 V. The encoder has two channels. The main unit uses quadrature decoding to compute position and direction information.

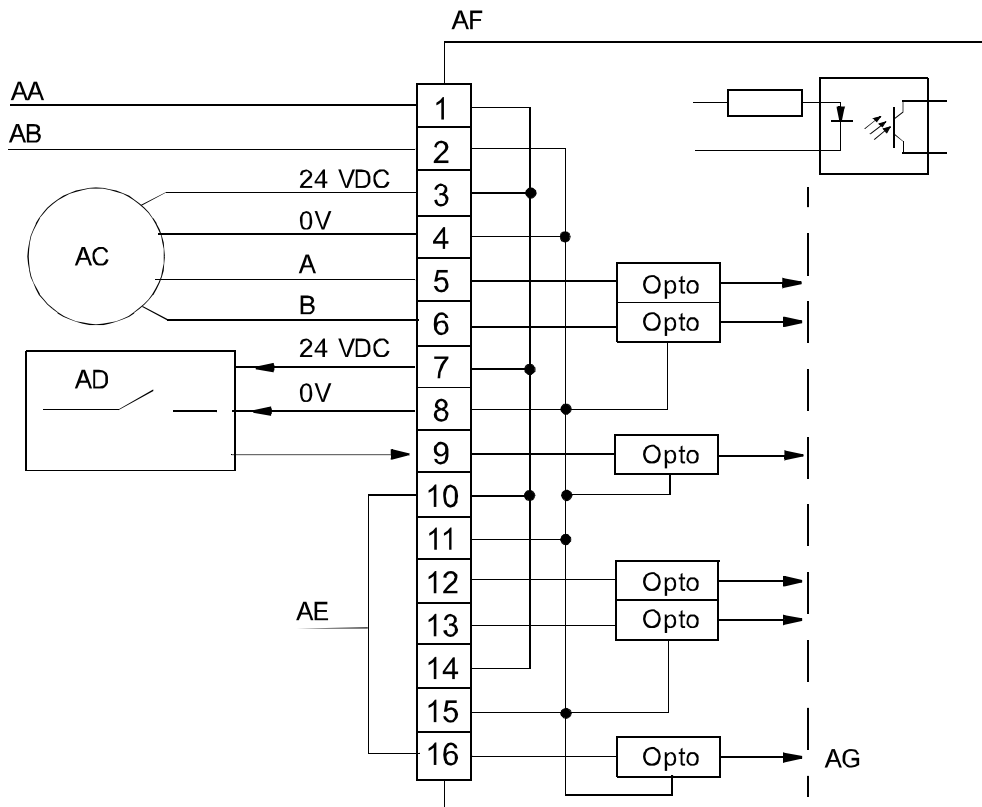

xx010000234

|    |                             |
|----|-----------------------------|
| AA | 24 V I/O or external supply |
| AB | 0 V I/O or external supply  |
| AC | Encoder                     |
| AD | Sync switch                 |
| AE | 10-16 not used              |

*Continues on next page*

|    |                        |
|----|------------------------|
| AF | Encoder interface unit |
| AG | Galvanic isolation     |

#### Connector X3

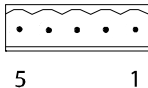

Connector1-5

The table below shows the connections to connector X3:

| Signal name | X3 pin | Function                |
|-------------|--------|-------------------------|
| 0 VDC       | 1      | Supply voltage GND      |
| NC          | 2      | Not connected           |
| GND         | 3      | Ground connection       |
| NC          | 4      | Not connected           |
| + 24 VDC    | 5      | Supply voltage + 24 VDC |

#### Connector X5

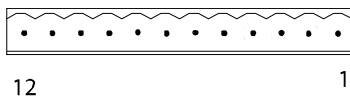

xx0100000244

Connector X5 is a DeviceNet connector specified in section [Setting DeviceNet bus ID on page 62](#).

*Continues on next page*

## 5 Boards and units

### 5.2.10. DSQC 377A, Queue tracking unit

*Continued*

#### Connector X20

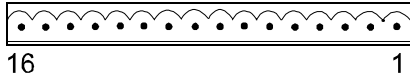

xx0100000235

X20 is the encoder and digital input connector.

The table below shows the connections to connector X20:

| Signal name              | X20 pin |
|--------------------------|---------|
| 24 VDC supply            | 1       |
| 0 V                      | 2       |
| Encoder 1 - 24VDC        | 3       |
| Encoder 1 - 0V           | 4       |
| Encoder 1 - Phase A      | 5       |
| Encoder 1 - Phase B      | 6       |
| Digital input 1 - 24 VDC | 7       |
| Digital input 1 - 0 V    | 8       |
| Digital input 1 - Signal | 9       |
| Not used                 | 10      |
| Not used                 | 11      |
| Not used                 | 12      |
| Not used                 | 13      |
| Not used                 | 14      |
| Not used                 | 15      |
| Not used                 | 16      |

*Continues on next page*

#### Board specific LEDs

The table below shows the significance of the LEDs on the board. For location of the LEDs see *Illustration of DSQC 377A on page 140*.

| Designation   | Color     | Description   |
|---------------|-----------|---|
| POWER, 24 VDC | Green     | <p>Indicates that a supply voltage is present, and has a level above 12 VDC.</p> <p>If there is no light, check that voltage is present on power unit and in connector X20. If not, check cables and connectors.</p> <p>If power is applied to the unit but it does not work, replace the unit.</p>   |
| NS/MS         | Green/red | <p>Network and module status LEDs. See section <a href="#">DeviceNet Bus and I/O board status LED description on page 55</a>.</p>   |
| CAN Tx/CAN Rx | Green/red | <p>See section <a href="#">DeviceNet Bus and I/O board status LED description on page 55</a>.</p>   |
| ENC 1A/1B     | Green     | <p>Indicates phase 1 and 2 from encoder. Flashes at each Encoder pulse. At frequencies higher than a few Hz, flashing can no longer be observed (light will appear weaker).</p> <p>If there is no light, there is an error due to one or more of the following reasons:</p> <ul style="list-style-type: none"> <li>Faulty power supply for input circuit (internal or external).</li> <li>Defective input circuit on board.</li> <li>Short circuit or broken wire in external wiring or connectors.</li> <li>Internal error in unit.</li> </ul> <p>Constant light indicates constant high level on input and vice versa.</p> <p>No light on one LED indicates fault in one encoder phase.</p> |

*Continues on next page*

## 5 Boards and units

---

### 5.2.10. DSQC 377A, Queue tracking unit

*Continued*

| <b>Designation</b> | <b>Color</b> | <b>Description</b>  |
|--------------------|--------------|---|
| DIGIN1             | Green        | Lit when digital input is active.<br>The input is used for external start signal/conveyor synchronization point.<br>If there is no light, there is an error due to one or more of the following reasons: <ul style="list-style-type: none"><li>• Faulty power supply for input circuit (internal or external).</li><li>• Faulty limit switch, photocell etc.</li><li>• Short circuit or broken wire in external wiring or connectors.</li><li>• Defective input circuit on board.</li></ul> |
| ENC 2A/2B          |              | Not used.   |
| DIGIN2             |              | Not used.   |

*Continues on next page*

Input map

The figure below shows the input mapping.

**Note!** Pay attention to the order of the bits for the analog signals.

| Input byte | Bit         |            |                  |               |                |                |              |            | Bit range |
|------------|-------------|------------|------------------|---------------|----------------|----------------|--------------|------------|-----------|
|            | 7           | 6          | 5                | 4             | 3              | 2              | 1            | 0          |           |
| 0          | Position    |            |                  |               |                |                |              |            | 0-31      |
| 1          |             |            |                  |               |                |                |              |            |           |
| 2          |             |            |                  |               |                |                |              |            |           |
| 3          |             |            |                  |               |                |                |              |            |           |
| 4          | Speed       |            |                  |               |                |                |              |            | 32-63     |
| 5          |             |            |                  |               |                |                |              |            |           |
| 6          |             |            |                  |               |                |                |              |            |           |
| 7          |             |            |                  |               |                |                |              |            |           |
| 8          | ObjectsInQ  |            |                  |               |                |                |              |            | 64-71     |
| 9          | CntFromEnc1 |            |                  |               |                |                |              |            | 72-87     |
| 10         |             |            |                  |               |                |                |              |            |           |
| 11         | CntFromEnc2 |            |                  |               |                |                |              |            | 88-103    |
| 12         |             |            |                  |               |                |                |              |            |           |
| 13         | N.U.        | EncA Fault | Encoder Selected | NewObj Strobe | Pass Stw       | Ready          | Null Speed   | Connected  | 104-111   |
| 14         | N.U.        | N.U.       | N.U.             | N.U.          | PowerUp Status | ScaleEnc Pulse | DirOf Travel | Simulating | 112-119   |
| 15         | TimeStamp   |            |                  |               |                |                |              |            | 120-151   |
| 16         |             |            |                  |               |                |                |              |            |           |
| 17         |             |            |                  |               |                |                |              |            |           |
| 18         |             |            |                  |               |                |                |              |            |           |

en040000816

*Continues on next page*



## 5 Boards and units

### 5.2.10. DSQC 377A, Queue tracking unit

*Continued*

#### **Note!**

The signals *CntFromEnc1*, *CntFromEnc2*, and *ScaleEncPulse* are dependent on the signal *PosInJobQ* (bit 42 in the output map). DSQC377-mode is obtained by setting the output signal to 1, and DSQC354-mode is obtained by setting the output signal to 0.

Generally *PosInJobQ* concerns only the queue tracking mode. All signals on the 377 are available even in DSQC354-mode (*c1PosInJobQ*=0). The only thing *c1PosInJobQ* disables, is that the object position is not sent to the main controller.

Following table specifies the input signals.

| Signal name  | Type | Bit    | Description   |
|--------------|------|--------|---|
| Position     | AI   | 0-31   | Position in meters of the first object in the queue.<br>Accuracy: 0.1 mm  |
| Speed        | AI   | 32-63  | Speed of the conveyor in m/s.<br>Resolution: 10 µm/s  |
| ObjectsInQ   | GI   | 64-71  | Number of objects in queue (0-255).<br>Objects that have entered the queue (passed the sync switch) but have not left the queue (have become connected or gone outside the start window). |
| CntFromEnc1  | GI   | 72-87  | Counter value from encoder to controller (Low Word).<br>The bit group is valid for DSQC377-mode, i.e. when <i>PosInJobQ</i> is set to 1.  |
| CntFromEnc2  | GI   | 88-103 | Counter value from encoder to controller (High Word).<br>The bit group is valid for DSQC377-mode, i.e. when <i>PosInJobQ</i> is set to 1.   |
| Connected    | DI   | 104    | Set when an object is being tracked.  |
| NullSpeed    | DI   | 105    | Set when the conveyor is stopped.   |
| Ready        | DI   | 106    | Internal handshake signal (toggled).  |
| PassStw      | DI   | 107    | Set when an object has gone outside the start window or has fallen off the conveyor.  |
| NewObjStrobe | DI   | 108    | New position from the encoder node to enter the job queue.<br>The bit is valid for DSQC377-mode, i.e. when <i>PosInJobQ</i> is set to 1.  |

*Continues on next page*

| Signal name   | Type | Bit     | Description  |
|---------------|------|---------|--|
| EncSelected   | DI   | 109     | Indicates which encoder is active.<br>0 = EncA (must be 0)<br>The bit is valid for DSQC377-mode, i.e. when <i>PosInJobQ</i> is set to 1.   |
| EncAFault     | DI   | 110     | Encoder A is faulty.<br>The bit is valid for DSQC377-mode, i.e. when <i>PosInJobQ</i> is set to 1.   |
| N.U.          |      | 111     | Not used.  |
| Simulating    | DI   | 112     | Module is in simulated mode, i.e. <i>Speed</i> and <i>Position</i> are simulated rather than taken from the actual encoder.<br>The bit is valid for DSQC377-mode, i.e. when <i>PosInJobQ</i> is set to 1.    |
| DirOfTravel   | DI   | 113     | Indicates the direction of the conveyor.<br>0 = Backward<br>1 = Forward  |
| ScaleEncPulse | DI   | 114     | The encoder pulse scaled down by the factor given by the command <i>ScalingFactor</i> .  |
| PowerUpStatus | DI   | 115     | Indicates how the last shutdown was made.<br>0 = Abnormal<br>1 = Normal  |
| N.U.          |      | 116-119 | Not used.  |
| TimeStamp     | GI   | 120-151 | Holds the time when following signals were last sampled: <ul style="list-style-type: none"> <li>• <i>Position</i></li> <li>• <i>Speed</i></li> <li>• <i>Connected</i></li> <li>• <i>NullSpeed</i></li> </ul> |

## 5 Boards and units

### 5.2.10. DSQC 377A, Queue tracking unit

*Continued*

#### Output map

The figure below shows the output signals mapping.

| Output byte | Bit       |      |              |            |             |            |           |              | Bit range |       |
|-------------|-----------|------|--------------|------------|-------------|------------|-----------|--------------|-----------|-------|
|             | 7         | 6    | 5            | 4          | 3           | 2          | 1         | 0            |           |       |
| 0           | Sim Mode  | N.U. | Soft SyncSig | Enc Select | RemAll PObj | Rem1 PObj  | DropW Obj | WaitW Obj    | 0-7       |       |
| 1           | CntToEnc1 |      |              |            |             |            |           |              | LSB       | 8-23  |
| 2           |           |      |              |            |             |            |           |              |           |       |
| 3           | CntToEnc2 |      |              |            |             |            |           |              | LSB       | 24-39 |
| 4           |           |      |              |            |             |            |           |              |           |       |
| 5           | N.U.      | N.U. | N.U.         | N.U.       | N.U.        | PosIn JobQ | Force Job | CntTo EncStr | 43-47     |       |

en040000817

#### Note!

The signals *CntToEnc1*, *CntToEnc2*, and *CntToEncStr* are dependent on the signal *PosInJobQ* (bit 42 in the output map). DSQC377-mode is obtained by setting the signal to 1, and DSQC354-mode is obtained by setting the signal to 0.

Generally *PosInJobQ* concerns only the queue tracking mode. All signals on the 377 are available even in DSQC-354 mode (*c1PosInJobQ*=0). The only thing *c1PosInJobQ* disables, is that the object position is not sent to the main controller.

Following table specifies the output signals.

| Signal name | Type | Bit | Description  |
|-------------|------|-----|--|
| WaitWObj    | DO   | 0   | Set when the robot is waiting for an object to enter the start window.                     |
| DropWObj    | DO   | 1   | Drop and disconnect the currently tracked object. The object is removed from the queue.    |
| Rem1PObj    | DO   | 2   | Remove first pending object from the queue. (If an object is connected it is not removed.) |

*Continues on next page*

| Signal name | Type | Bit   | Description   |
|-------------|------|-------|---|
| RemAllPObj  | DO   | 3     | Remove all pending objects in the queue. (If an object is connected it is not removed.)   |
| EncSelect   | DO   | 4     | Select encoder:<br>0=EncA (must be 0)<br>1=EncB, not used   |
| SoftSyncSig | DO   | 5     | Soft sync-signal<br>This signal can be used instead of a physical signal connected to Digital input 1 of the module.  |
| N.U.        |      | 6     | Not used.   |
| SimMode     | DO   | 7     | If set this signal set the module in simulation mode (simulate Position and Speed instead of using the encoder values).<br>The bit is valid for DSQC377-mode, i.e. when <i>PosInJobQ</i> is set to 1. |
| CntToEnc1   | GO   | 8-23  | Counter value from controller to encoder (Low Word).<br>The bit group is valid for DSQC377-mode, i.e. when <i>PosInJobQ</i> is set to 1.  |
| CntToEnc2   | GO   | 24-39 | Counter value from controller to encoder (High Word).<br>The bit group is valid for DSQC377-mode, i.e. when <i>PosInJobQ</i> is set to 1.   |
| CntToEncStr | DO   | 40    | Indication to module that the "CntToEncX" signals contain valid values.<br>The bit is valid for DSQC377-mode, i.e. when <i>PosInJobQ</i> is set to 1.   |
| ForceJob    | DO   | 41    | Run this job even if checkpoint fails (always set/reset together with the CntToEncStr signal).<br>The bit is valid for DSQC377-mode, i.e. when <i>PosInJobQ</i> is set to 1.                          |
| PosInJobQ   | DO   | 42    | Set if the module shall send encoder values to the controller instead of handling the queue itself.<br>0=Queue tracking disabled (DSQC354-mode)<br>1=Queue tracking enabled                           |
| N.U.        |      | 43-47 | Not used.   |

## 5 Boards and units

---

### 5.2.10. DSQC 377A, Queue tracking unit

*Continued*

#### Additional information

For detailed information on using the DSQC 377A in an application refer to *Application manual - Motion coordination and supervision*, see *References on page 12*.

**D**

DeviceNet generic unit type 40  
DSQC 327A 65  
DSQC 327A, connector X1 67  
DSQC 327A, connector X2 68  
DSQC 327A, connector X3 69  
DSQC 327A, connector X4 70  
DSQC 327A, connector X5 70  
DSQC 327A, connector X6 71  
DSQC 328A 74  
DSQC 328A, connector X1 76  
DSQC 328A, connector X2 77  
DSQC 328A, connector X3 78  
DSQC 328A, connector X4 79  
DSQC 328A, connector X5 79  
DSQC 332A 81  
DSQC 332A, connector X1 85  
DSQC 332A, connector X2 86  
DSQC 332A, connector X3 87  
DSQC 332A, connector X4 88  
DSQC 332A, connector X5 89  
DSQC 350A 100  
DSQC 350A, connector X3 102  
DSQC 350A, connector X5 102  
DSQC 350A, connector X8 103  
DSQC 350A, connector X9 103  
DSQC 351A 109  
DSQC 351A, connector X20 113  
DSQC 351A, connector X21 114  
DSQC 351A, connector X3 112  
DSQC 351A, connector X5 112  
DSQC 352A 119  
DSQC 352A, connector X20 122  
DSQC 352A, connector X3 121  
DSQC 352A, connector X5 122  
DSQC 355A 90  
DSQC 355A, connector X3 92  
DSQC 355A, connector X5 92  
DSQC 355A, connector X7 93  
DSQC 355A, connector X8 94  
DSQC 377A 139  
DSQC 377A, connector X20 144  
DSQC 377A, connector X3 143  
DSQC 377A, connector X5 143

DSQC 378A 128

DSQC 378A, connector X3 130

DSQC 378A, connector X5 131

DSQC 378A, connector X8 131

**S**

system parameter, Connection 1 Interval 51

system parameter, Connection 1 Output Size 52

system parameter, Connection 1 Type 51

system parameter, Connection1 Input Size 52

system parameter, Device Type 49

system parameter, DeviceNet Address 48

system parameter, DeviceNet Communication Speed 47

system parameter, DeviceNet Master Address 47

system parameter, Explicit Messaging 50

system parameter, Major Revision 49

system parameter, Minor Revision 50

system parameter, Path 53

system parameter, Product Code 49

system parameter, Production Inhibit Time 50

system parameter, Service 53

system parameter, Vendor ID 49

**T**

topic I/O, Bus 37, 47

topic I/O, Fieldbus Command Type 53

topic I/O, Unit 37, 48

topic I/O, Unit Type 37, 49



ABB Automation Technologies AB  
Robotics  
S-721 68 VÄSTERÅS  
SWEDEN  
Telephone: +46 (0) 21 344000  
Telefax: +46 (0) 21 132592