



WRIST CAMERA

VISION MADE FOR UNIVERSAL ROBOTS

Original Notice

© 2021 Robotiq Inc.

Robotiq Wrist Camera
for Universal Robots



Instruction Manual

LEAN 
ROBOTICS
robotiq.com | leanrobotics.org

Revisions	4
1. General Presentation	8
1.1. Vision components	8
2. Safety	12
2.1. Warning	13
3. Installation	15
3.1. Scope of Delivery	15
3.2. Required Tools and Equipment	17
3.3. Environmental and Operating Conditions	18
3.4. Mechanical Installation	18
3.5. Electrical Setup	21
4. Software	23
4.1. Installation, Uninstallation and Updates	23
4.2. Snapshot Position	27
4.3. Object Teaching	35
4.4. Teach Object Wizard	37
4.5. Cam Locate node	88
4.6. Scan Code node	104
4.7. Using the Scan code Node	106
4.8. Find and Apply Visual Offset nodes and Defining tags	108
4.9. Save Image node	117
5. Specifications	119
5.1. Mechanical Specifications	120
5.2. Electrical and Optical Specifications	122
5.3. Vision System Specifications	123
6. Maintenance	127
7. Spare Parts, Kits and Accessories	128
8. Troubleshooting	129
9. Warranty and Patent	130
10. Declarations and Certificates	132
10.1. Original Declaration of Incorporation	132



10.2. Ingress Protection Certificate	133
11. Contact	134



Revisions

2021-05-21

- Update of the Installation section.

2021-04-06

- New 5-m high flex cable for the Robotiq Wrist Camera.
- Update of the Installation section.
- Update of the Software section.
- Update of the Cam Locate node section.
- Update of the Find and Apply Visual Offset node section.
- Update of the Specifications, Spare parts and Declaration & Certificates sections.

2020-07-28

- Find and Apply Visual Offset nodes and Defining Tags section: updates
- Snapshot Position section: updates
- Object Teaching section: add of the Import CAD model and updates

2019-10-29

- Modified appearance of text boxes.
- Added dynamic cross-references to sections of the Instruction Manual.
- Section "Required Tools and Equipment"
 - Modified electrical ratings shown in Table 1-1: Robotiq Wrist Camera and gripper power supply requirements
 - Updated recommended optional equipment
- Subsection " Snapshot Position " :
 - Rewrote subsection with a more detailed workflow
 - Added screenshots and printing specifications for the calibration board
- Section "Cam Locate Node" :
 - Renamed subsection " Settings" to "Camera Locate Settings"
 - Added typical use tips for options under the "Camera Locate Settings" window
 - Added " Autopick" subsection
- Section " Scan Code Node " :
 - Added subsection "Guidelines on Reading Codes"
 - Added subsection " Strings Data Stored in CSV files"



- Section " Intended Use " : since barcodes and 2D codes is now supported by the Wrist Camera, URCap, removed a sentence that mentioned it was not.
- Section "Object Teaching" : removed all mentions of the play button and question mark button which were used to access contextual help contents. This contextual help has since been removed from the Wrist Camera URCap.

2019-10-24

- Fixed numbering error in Table of Contents.
- Streamlined instructions in many instances, with lighter formatting.

2019-10-17

- Renamed section " Programming with the Camera Locate Node " to " Cam Locate Node " .
- Added sections:
 - Save Image Node
 - Scan Code Node
 - Find Visual Offset and Apply Visual Offset Nodes, and Defining Tags
- Added subsections:
 - In " Cam Locate Node "
 - In " Snapshot Position "
- Added two SKU to section " Spare Parts, Kits and Accessories "
 - ACC-TAG-1BAG5
 - ACC-TAG-5BAG5 (partners only)

2019-05-08

Updated section 5. Gripper Clearance Validation feature added.

2019-03-07

- Updated section 5 and all pertaining subsections; major changes to the Camera settings. Align-to-axis and Align over features added.

2018-09-10

- Updated section 3, 5 and 6 according to the PolyScope version of the user (CB-Series vs. e-Series).
- Updated section 5 and all pertaining subsections; major changes to the Teach object wizard (color validation layer masks, multiple object detection, e-Series support).

2018-05-01

- Updated section 5 and all pertaining subsections; major changes to the Teach object wizard

2018-03-26

- Updated Section 3.6.2 for Update and uninstall



2017-06-07

- Updated Section 3.6 for URCap package installation procedure
- Updated Section 4.2 for calibration process
- Updated Sections 5.2, 5.2.1, 5.2.2, 5.2.3 for new and improved teaching methods.
- Added Section 6.2 to use advanced programming with the vision system.
- Updated technical specifications (Section 7.3).
- Updated calibration board for UR5 and UR10 robots (Section 4)

2016-11-16

- Updated specifications (section 6)
- Updated installations instructions (section 4)
- Added Troubleshooting instructions (section 9.1)

2016-08-26

First release



Copyright

© 2016-2021 Robotiq Inc. All rights reserved.

This manual and the product it describes are protected by the Copyright Act of Canada, by laws of other countries, and by international treaties, and therefore may not be reproduced in whole or in part, whether for sale or not, without prior written consent from Robotiq. Under copyright law, copying includes translation into another language or format.

Information provided by Robotiq in this document is believed to be accurate and reliable. However, no responsibility is assumed by Robotiq for its use. There may be some differences between the manual and the product if the product has been modified after the edition date.

The information contained in this document is subject to change without notice.



1. General Presentation

The terms "Camera" and "Wrist Camera" used in the following manual all refer to the RobotiqWrist Camera, while the terms "Vision" and "Vision System" used in the following manual all refer to the RobotiqWrist Camera Vision System for Universal Robots.

The Vision System uses the RobotiqWrist Camera and the Camera Locate software on Universal Robots to provide you with a simple object teaching interface.

The interface allows to set up the Vision system so it can recognize object locations and orientations automatically. It locates one object at a time on a predefined workplane, gets the object position (x, y) and orientation along the z-axis, and allows to operate the robot according to the object location. The Wrist Camera is designed for industrial applications in combination with Robotiq adaptive grippers.

Info

This manual uses the metric system. Unless otherwise specified, **all dimensions are in millimeters.**

Info

The following section presents the key features of the Camera and must not be considered as appropriate to the operation of

the Camera. Each feature is detailed in the appropriate section.

1.1. Vision components

The figure below describes the various components of the Robotiq Vision system for Universal Robots. This system will use the Robotiq Wrist Camera, used with any of these mentioned Universal Robots versions (UR3, UR5, UR10, UR16). The system is compatible with the CB3.1 controller or later, as well as any e-Series releases. For a list of provided components with your RobotiqWrist Camera kit, see the **Scope of Delivery** section.

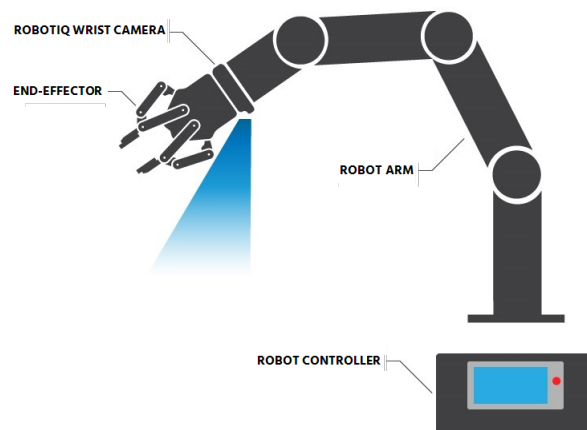

Fig. 1-1: Robotiq Wrist Camera Vision system hardware



Info	
Robotiq Wrist Camera	Automatic 5Mpx camera fitted with LED and made for collaborative robots, either independently or with an end-effector.
End-Effector	Tool incorporated to a robot arm via its tool flange.
Robot arm	Any collaborative robot.
Robot Controller	Computer that controls the robot, its end-effector and/or third party devices.

1.1.1. Calibration, Snapshot position and Workspace

The figure below illustrates the various terms used in the following manual to describe the Vision System's Snapshot Position and workspace. The first step, when installing your camera on the robot, is to perform a camera calibration using the provided Calibration board.

This calibration process is simple and very powerful. After taking the required poses, it determines three (3) important things:

1. Optical parameters of your camera;
2. Camera position on the robot's wrist;
3. Calibration board (Workplane) position regarding the robot space.

Any camera installation and uninstallation from the robot must be followed by a new calibration to ensure an optimum and repeatable performance. When Teaching a new model, the object location process will always start at the snapshot position. That position will determine the field of view of the Wrist Camera i.e. the workspace. Consult the **Snapshot Position** section for more details.

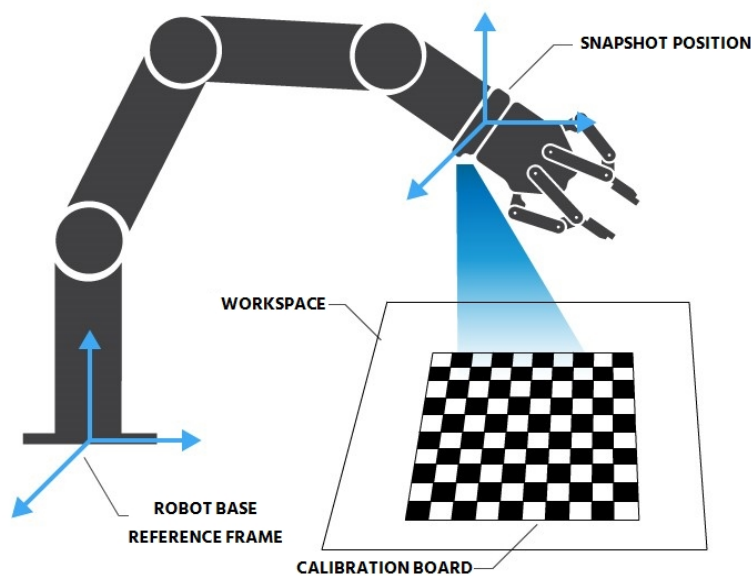

Fig. 1-2: Robotiq Vision System snapshot position and workplane concepts



Info	
Snapshot Position	Robot pose used to take snapshots with the Wrist Camera.
Work Plane	Area of interest for the Vision System. Fits the field of view of the Wrist Camera.
Object	Object to locate using the Vision System.
Calibration board	Grid provided with the Wrist Camera. Used in the calibration process of the snapshot position.

1.1.2. Object Location

To locate objects, the Vision System uses the Cam Locate node. The figure below represents the process.

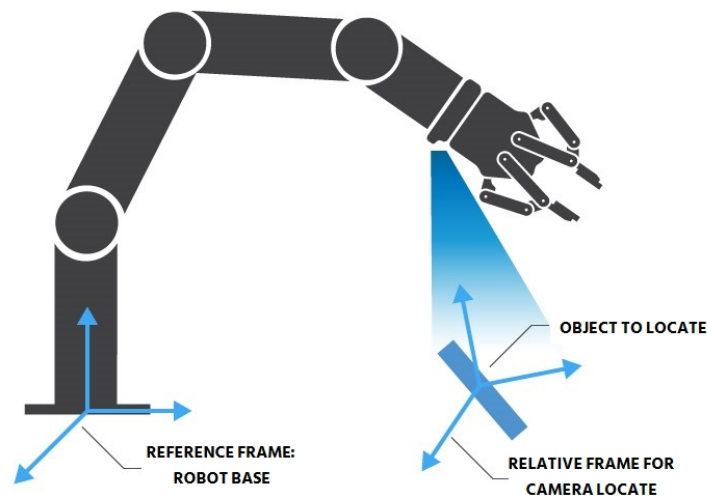

Fig. 1-3: Representation of the object location process

Info	
Object to locate	Object to locate using coordinates x , y , and R_z (rotation).
Camera locate relative frame	Reference frame, as updated by the Vision System, used to locate an object.
Robot base reference frame	Frame coordinates defined as $[0,0,0]$.



1.1.3. Wrist Camera

The hardware of the Vision system is the Robotiq Wrist Camera.

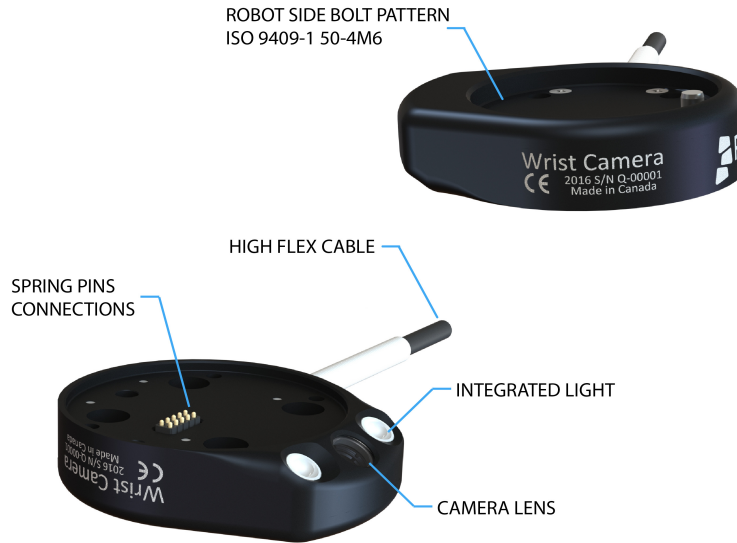

Fig. 1-4: Main features of the Wrist Camera

Hardware	Specifications
CMOS image sensor with liquid lens	<ul style="list-style-type: none"> Resolution: 0.3 to 5Mpx Frame rate: 2 to 30 FPS Focus: 70mm to ∞
6 LED	<ul style="list-style-type: none"> Diffuse white light Automatic control
5-m high flex cable	<ul style="list-style-type: none"> USB 2.0 24 VDC power
Tool flange: ISO 9409-1:2004 4 X M6 \varnothing 50mm bolt pattern	<ul style="list-style-type: none"> Wrist Camera is mounted on the tool flange Grippers are mounted on the Wrist Camera

Info

The Robotiq Wrist Camera provides a direct mounting interface for grippers, including a mechanical interface, 24V power and gripper/robot communication capabilities.



2. Safety

Warning

The operator must have read and understood all of the instructions in the following manual before operating the Robotiq Wrist Camera.

Caution

The term "operator" refers to anyone responsible for any of the following operations on the Robotiq Wrist Camera:

- Installation
- Control
- Maintenance
- Inspection
- Calibration
- Programming
- Decommissioning

This manual covers the various components of the Robotiq Wrist Camera and the general operations regarding the whole life-cycle of the product, from installation to operation and decommissioning.

The drawings and photos in this manual are representative examples. However, discrepancies may be observed between the visual supports and the actual product.



2.1. Warning

Caution

Any use of the Wrist Camera in non-compliance with these warnings is deemed inappropriate and may cause injury or damage.

Warning

The Wrist Camera Vision System used in human-robot collaboration must not be considered a complete safety measure, additional dedicated safety device(s) must be considered. Vision System failure can occur and result in danger for workers or machinery if not properly secured. See local or international safety measure for human-robot collaboration.

Warning

- Secured the Wrist Camera before operating the robot.
- Do not install or operate a Wrist Camera that is damaged or lacking parts.
- Only supply direct current to the Wrist Camera.
- Make sure all cords are secured at both the Wrist Camera and the robot levels.
- Always respect the recommended keying for electrical connections.
- Before running a program, make sure that neither obstacles nor people are in the robot path.
- All local safety measures and/or laws on robot operation must be applied to the Vision System.
- Avoid looking straight at the LED when they are turned on, as this may cause dazzlement.
- Any use of the Vision System in noncompliance with these warnings is inappropriate and may cause injury or damage.

2.1.1. Risk assessment and intended use

The Vision System is designed to locate objects laying flat on the defined workspace. The system can identify and locate multiple kind of objects, each object will require its own object teaching process as explained in the **Object Teaching** section . The Vision system gets the object's position (x, y) and orientation along the z axis. It allows to operate the robot according to the object location.

Tip

The **Snapshot Position** section will give you advice on what workspace should be used or avoided. **Object Teaching** section will give you advice on what objects can be located or not, including recommendations on using backgrounds.



Caution

The Vision System is not intended for metrology applications.

Note

Always comply with local and/or national laws, regulations and directives on automation safety and general machine safety.

The unit may be used only within the range of its technical specifications. Any other use of the product is deemed improper and unintended use. Robotiq will not be liable for any damages resulting from any improper or unintended use.



3. Installation

The following subsections will guide you through the installation and general setup of your Robotiq Wrist Camera.

Warning

Before installing:

- Read and understand the safety instructions related to the Vision System.
- Verify your package according to the scope of delivery and your order.
- Make sure to have the required parts, equipment and tools listed in Scope of delivery.

Warning

When installing:

- Meet the recommended environmental conditions.
- Do not operate the Vision System, or even turn on the power supply, before the device is firmly anchored and the machine area is cleared.

3.1. Scope of Delivery

Info

The following kits include the new 5-m high flex cable that comes with the Robotiq Wrist Camera. If you have the older 10-m high flex cable, please consult the last version of this instructions manual available in the Archives section of our [support website](#), for more information.

3.1.1. RWC5-UR-KIT

Includes the Wrist Camera and required hardware.

- Robotiq Wrist Camera with 5-m high flex cable
- Pattern Tool plate for ISO 9409-1-50-4-M6 (not included and not required if purchased as part of a combo)
- USB stick
- USB software license dongle
- 4-port USB hub
- Calibration board
- Colored background for object teaching



- Hardware kit to mount the Wrist Camera to Universal Robots.
- Wrist Camera Tags for Visual Offset (5)

3.1.2. CUR-AGC-085-RWC5 or CUR-AGC-140-RWC5

Includes a 2-Finger Adaptive Gripper and a Wrist Camera.

- Wrist Camera Kit for Universal Robots includes:
 - Robotiq Wrist Camera with 5-m high flex cable
 - USB stick
 - USB software license dongle
 - 4-port USB hub
 - Calibration board
 - Colored background for object teaching
 - Hardware to mount the Wrist Camera to robots.
 - Wrist Camera Tags for Visual Offset (5)
- Gripper parts:
 - Basic Gripper unit (85 or 140) AGC-GRP-002 or -140 (depending on selected combo)
 - Screws to mount gripper on Wrist Camera

3.1.3. CUR-HND-RWC5

- Wrist Camera Kit for Universal Robots includes:
 - Robotiq Wrist Camera with 5-m high flex cable
 - USB stick
 - USB software license dongle
 - 4-port USB hub
 - Calibration board
 - Colored background for object teaching
 - Hardware to mount the Wrist Camera to robots
 - Wrist Camera Tags for Visual Offset (5)
- Gripper parts:
 - Hand-E Gripper unit
 - Hand-E fingertip starting kit
 - Screws to mount gripper on Wrist Camera



3.2. Required Tools and Equipment

- The following tools are required to install the Wrist Camera:
 - 2 mm slotted screwdriver (not provided) to perform terminal block connections when wiring.
 - 4 mm hex key to mount the Wrist Camera on a Universal Robots model.
- The following parts are required for setup:
 - A Universal Robots UR3, UR5, UR10 or UR16 model, along with its controller

Warning

Only compatible with controller version CB3.1 and later.

Tip

Make sure you have the latest Polyscope version installed in order to install the URCaps.

- Power supply if not using a Universal Robots controller supply (see below);
- Fuse, see information below.

The Wrist Camera needs to be supplied by a DC voltage source. This power supply is not included with the Wrist Camera Kit for Universal Robots. Required power supply must match the Robotiq device. The following table shows the specifications with regards to the power supply required to operate the Wrist Camera and the optional Robotiq gripper.

SPECIFICATION	VALUE
Output voltage	24 V DC \pm 10%
Output current	2 A
Over current	Recommended power supply with internal protection, otherwise fusing is required. 4 A fuse at 25°C [77°F] ¹

Table 3-1: Robotiq Wrist Camera and gripper power supply requirements.

Info

¹Suggested fuse is a: Phoenix Contact # 0916606, 4A Thermal Breaker. Use AWG #20 wiring.



Warning

If your power supply exceeds the specified regulation, over-voltage protection is required.

Robotiq recommends using this power supply:

- For the 2A output current: TDK-Lambda DPP Series, 50W Single Output DIN Rail Mount Power Supply: **DPP50-24**.

3.3. Environmental and Operating Conditions

The Wrist Camera is designed for industrial applications. Always respect the following specified operating environmental conditions:

CONDITION	VALUE
Minimum storage	-30°C [-22°F]
Maximum storage	70°C [158°F]
Minimum operating temperature	0°C [32°F]
Maximum operating temperature	50°C [122°F]
Humidity (non-condensing)	Non-condensing.
IP Rating	IP67
Others	<p>Lenses must be free from dust, soot and water.</p> <p>Environment must be free from powerful electromagnetic interference.</p> <p>Environment must be free from corrosive or explosive liquids or gases.</p>

Table 3-2: Environmental and operating conditions for the Wrist Camera.

3.4. Mechanical Installation

3.4.1. Mounting the Wrist Camera with an end-effector on Universal Robots

1. Place the Wrist Camera on the robot arm. Align the wrist camera's dowel pin with tool flange.
2. Place the tool plate on the Wrist Camera. Align the tool plate dowel pin with the Wrist Camera.



3. Mount end-effector on robot arm, using M6 screws that pass through the tool plate and the Wrist Camera.
4. Attach cable along robot arm.

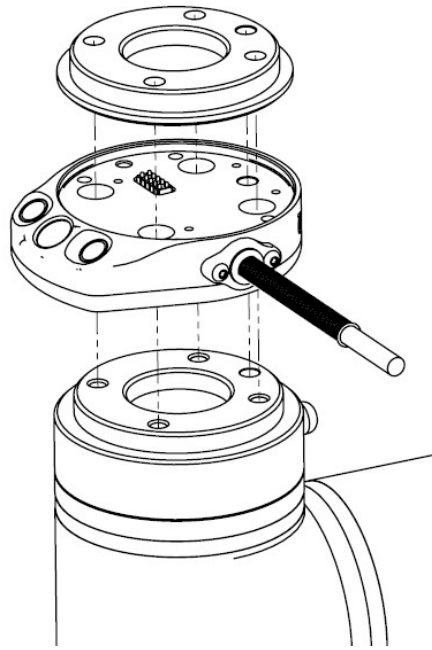

Fig. 3-1: Mounting the Wrist Camera kit on Universal Robots

Info

The end-effector is secured directly in the tool flange of the robot arm. Both the Wrist Camera and the tool plate are fitted with clearance holes for this assembly. M6 screws to mount an end-effector on the Wrist Camera are not provided. Use M6 screws of appropriate length to secure end-effector on robot arm.

Caution

When mounting only a Wrist Camera on a robot, the spring pins used to connect to grippers are exposed. Handle them carefully.



Warning

Wrist Camera must be oriented properly.

Do not offset the Wrist Camera from the Tool Center Point on the X and Y axes, or around the Z axis.

3.4.2. Mounting the Wrist Camera with a Gripper on Universal Robots

To mount a Wrist Camera and a Robotiq Adaptive Gripper on a Universal Robots machine, follow these instructions, and refer to the figure below:

1. Place the Wrist Camera on the robot arm. Align the Wrist Camera dowel pin with tool flange.
2. Mount the Wrist Camera on tool flange using the provided screws and lockwashers.
3. Mount the gripper on the Wrist Camera using the provided screws and lockwashers.
4. Attach cable along the robot arm.

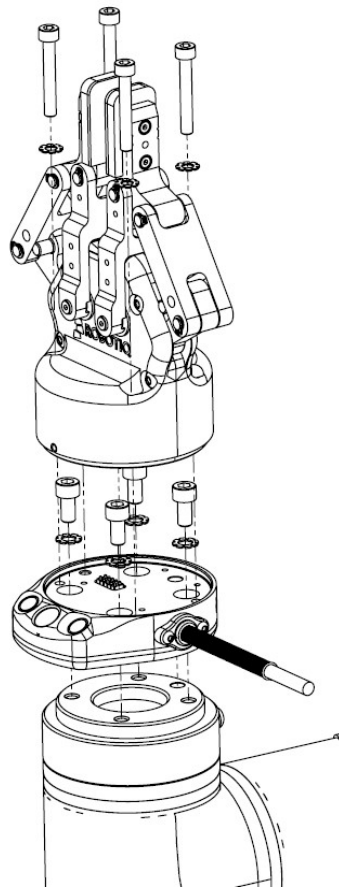

Fig. 3-2: Mounting both a Wrist Camera and a 2-Finger Adaptive Robot Gripper on a Universal Robots robot.



3.5. Electrical Setup

3.5.1. Pinout Interface

The Wrist Camera interfaces with an end-effector (e.g. Robotiq Grippers) via a 10-spring pin connector located on its outer surface.

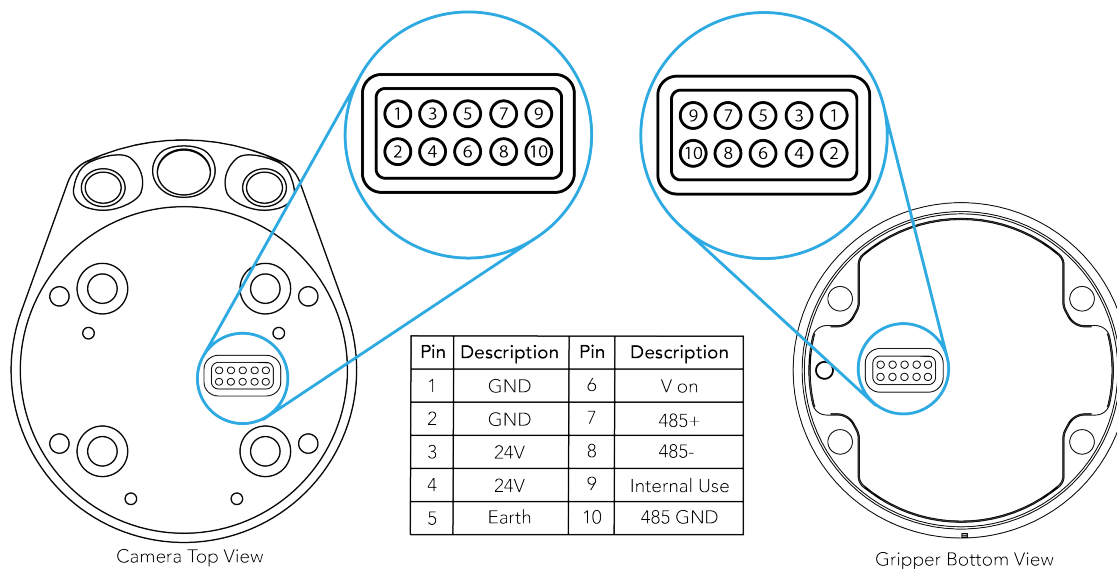

3.5.2. Power Supply

Caution

If mounting a 2-Finger Adaptive Gripper or a Hand-E Gripper on the Wrist Camera, the latter acts as a gripper coupling. Therefore, only the Wrist Camera device cable is required to provide power and communication to both itself and the gripper. Wiring setups are identical whether you use the Wrist Camera alone, or with an End-Effector.

Power and communication are established with the Wrist Camera via the 5-m high flex cable. It provides 24V power supply to the Wrist Camera and enables USB 2.0 communication with the Universal Robots controller. Follow the instructions to wire into the Universal Robots controller :

1. Turn off the robot controller.
2. Connect the 5-m high flex cable to the robot controller. Use any available 24 V and 0V slots.
 - Connect the red wire (24V).
 - Connect the black wire (0V).

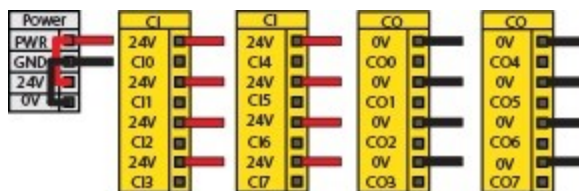

Fig. 3-3: Power supply wiring on CB3.1 Universal Robots controller



3. Connect the 4-port USB hub (ACC-USB-4-HUB) to the robot controller.
4. Connect the Wrist Camera USB cable to the 4-port USB hub.
5. Connect the USB license dongle (ACC-USB-DONGLE) to the 4-port USB hub.

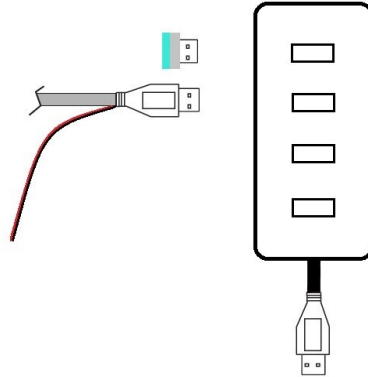

Fig. 3-4: Connecting to the 4-port USB hub

Info

Wrist Camera grounding is done via the robot ground. The Wrist Camera screws act as ground connectors when properly screwed with lock washers.

3.5.3. Cable Management

Warning

Use proper cabling management. Remember to leave enough mobile cable to allow for robot movement along all axes without pulling out connectors. Always protect the controller side of the cable connection with a strain relief cable clamp.



4. Software

Make sure the Wrist Camera is properly mounted on the robot arm and that all electrical wiring are correctly done (see **Mechanical Installation** section and **Electrical Setup** section).

Warning

Do not disconnect the USB stick or the USB license dongle from the robot controller, even after the installation has been completed.

Tip

Before using your Universal Robots, adjust the center of mass and payload from the Installation tab.

4.1. Installation, Uninstallation and Updates

4.1.1. Installing the URCap

Make sure the Wrist Camera is properly mounted to the robot arm (see **Mechanical Installation** section) and that all electrical wiring is correctly done (see **Electrical Setup** section). Make sure that your PolyScope version is up-to-date and that your Universal Robots controller is compatible with the Wrist Camera's URCap package.

Tip

For details on updating your URCap, see **Update and Uninstall** section

1. Go to support.robotiq.com.
2. Click Select Product > Wrist Camera > Universal Robots > Software > Wrist Camera Software > DOWNLOAD ZIP. This downloads the latest `UCC-X.X.X` compressed file.
3. Decompress the content of the latest `UCC-X.X.X` compressed file on the provided USB stick.
4. Place the `.urcap` file and the Vision System folder on the root of the USB drive.

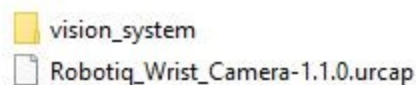

Fig. 4-1: Save these files at the root of the USB stick

5. With the robot controller ON, connect the USB stick containing the latest URCap and Vision System to the 4-port USB hub.



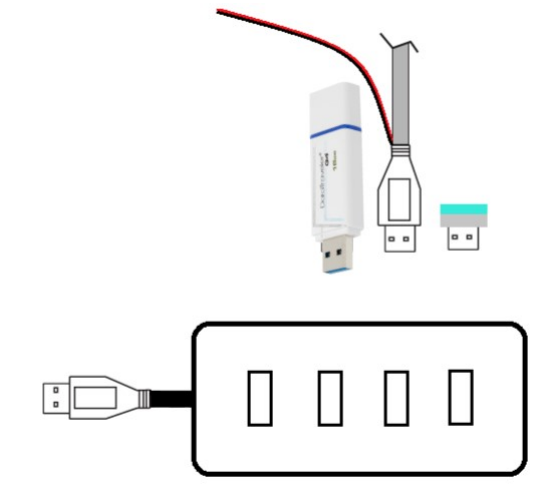

Fig. 4-2: Connecting to the 4-port USB hub.

For CB-Series

1. Tap **Setup Robot** > **URCaps Setup** > **+**, and select `Robotiq_Wrist_Camera-X.X.X.urcap` from the USB stick.
2. Tap **Restart**, and wait for Polyscope to reboot.
3. Tap **Program Robot** > **Installation** > **Camera** > **Dashboard** tab.
4. Check status of the Vision System.

For e-Series

1. Tap **☰** > **Settings** > **System** > **URCaps** > **+**, and select `Robotiq_Wrist_Camera-X.X.X.urcap` from the USB stick.
2. Tap **Restart**, and wait for Polyscope to reboot.
3. Tap **Installation** > **URCaps** > **Camera** > **Dashboard**.
4. Check status of the Vision System.

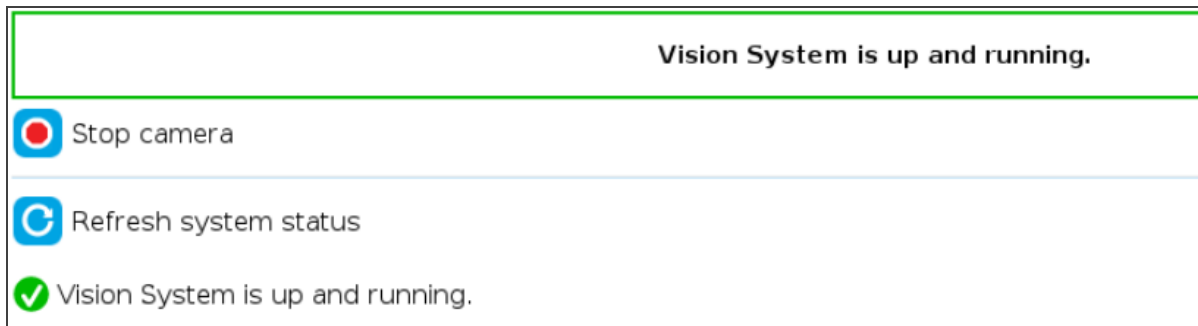

Fig. 4-3: The Camera dashboard indicates the Vision system has been correctly installed.

1. Tap **Install**. The Vision System installation starts.
2. If the firmware has to be updated, tap **Upgrade Camera firmware**. For details, see **Update and Uninstall** section



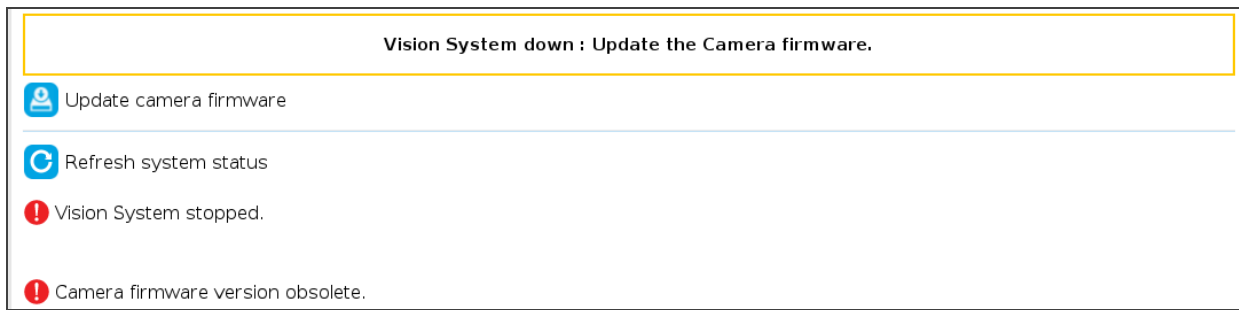

Fig. 4-4: The Camera tab indicates you must update the Wrist Camera firmware.

1. Wait for the Vision System to start.
2. The installation is completed.
3. In order to use another USB drive on the controller, reboot the robot controller.

Warning

Do not disconnect the USB stick or the USB license dongle from the robot controller, even after the installation has been completed.

Tip

The Dashboard tab contains helpful information for troubleshooting the Vision System.

Testing the Installation

After the installation has been completed, follow these instructions to check that the Vision System works as expected.

For CB-Series:

1. From a robot program, go to Installation tab >Camera> Dashboard.
2. Check system status. Make sure the Vision System is running.
3. Go to the Camera tab. The output image will appear.

For e-Series:

1. Tap Installation> URCaps > Camera > Dashboard.
2. Check the system status. Make sure the Vision System is running.
3. Go to the Camera tab. The output image will display.

Tip

Before using your Universal Robots, adjust the center of mass and payload from the Installation tab. For details, see section Mechanical Specifications.





4.1.2. Update and Uninstall

Warning



Updating the Wrist Camera software, unplugging the USB storage device and/or switching USB ports must **always** be done while the robot is initialized and running.

Version 1.1 and later

For CB-Series:



1. From a robot program, go to the Installation tab > Camera > Dashboard > Stop camera > Uninstall.
2. Remove the USB stick containing the URCap and Vision Server from the 4-port USB hub.
3. Tap **Setup Robot**> **URCaps Setup**.
4. In the Active URCaps text box, select the Camera URCap.
5. The Camera URCap is highlighted.
6. Tap  to uninstall the URCap.
7. Tap  to complete the uninstall process. The robot controller reboots.
8. Connect to a PC the USB stick containing the URCap and Vision Server.
9. Format USB stick in FAT32 format.
10. See **Software** section to install the latest software.

For e-Series:

1. Tap the **Installation** tab > **URCaps** > **Camera** > **Dashboard** > **Stop camera** > **Uninstall**.
2. Remove the USB stick.
3. Tap  > **SettingsSystem** > **URCaps**.
4. In the Active URCaps textbox, select the Camera URCap.
5. The Camera URCap is highlighted.
6. Tap  to uninstall the URCap.
7. Tap  to complete the uninstall process. The robot controller reboots.
8. Connect to a PC the USB stick containing the URCap and Vision Server.
9. Format USB stick in FAT32 format.
10. See **Software** section to install the latest software.



Version 1.1 and earlier

1. Copy the following file : `urmagic_uninstall.sh` to a blank USB stick.
2. From a robot program, go to the Installation tab > Camera > Camera > Stop Camera.
3. With the controller on, insert the USB stick containing the `urmagic` file into the Teach Pendant. The uninstallation procedure starts automatically.
4. Once uninstallation is complete, remove the USB stick containing the `urmagic` file.
5. Remove the USB stick containing the Vision Server.
6. Go to **Setup Robot > URCaps Setup**.
7. In the Active URCaps text box, tap the Camera URCap.
8. The Camera URCap is highlighted.
9. Tap  to uninstall the URCap.
10. Tap  to complete the uninstall process. The robot controller reboots.
11. Connect to a PC the USB stick containing the URCap and Vision Server.
12. Format USB stick in FAT32 format.
13. See **Software** section to install the latest software.

4.2. Snapshot Position

Prior to teaching objects with the Cam Locate URCap node , the operator must define a Snapshot position using the Snapshot Position wizard. For more details on the concepts of Snapshot position, Work plane and Calibration board, see **General Presentation** section. Read the following instructions to create a Snapshot Position.

4.2.1. Launching the Calibration and Snapshot Position Wizard

Go to the **Installation tab > URCaps > Camera > Snapshot** and tap .

When calibrating, three calibration methods are available.

Calibration Method	Definition	Purpose
New Snapshot Position	Using existing camera calibration and work plane.	For objects on the same work plane.
New Work Plane & Position	Using existing camera calibration.	For objects on a different work plane.
Full Calibration	New camera calibration, work plane and position.	Before first use of the camera.



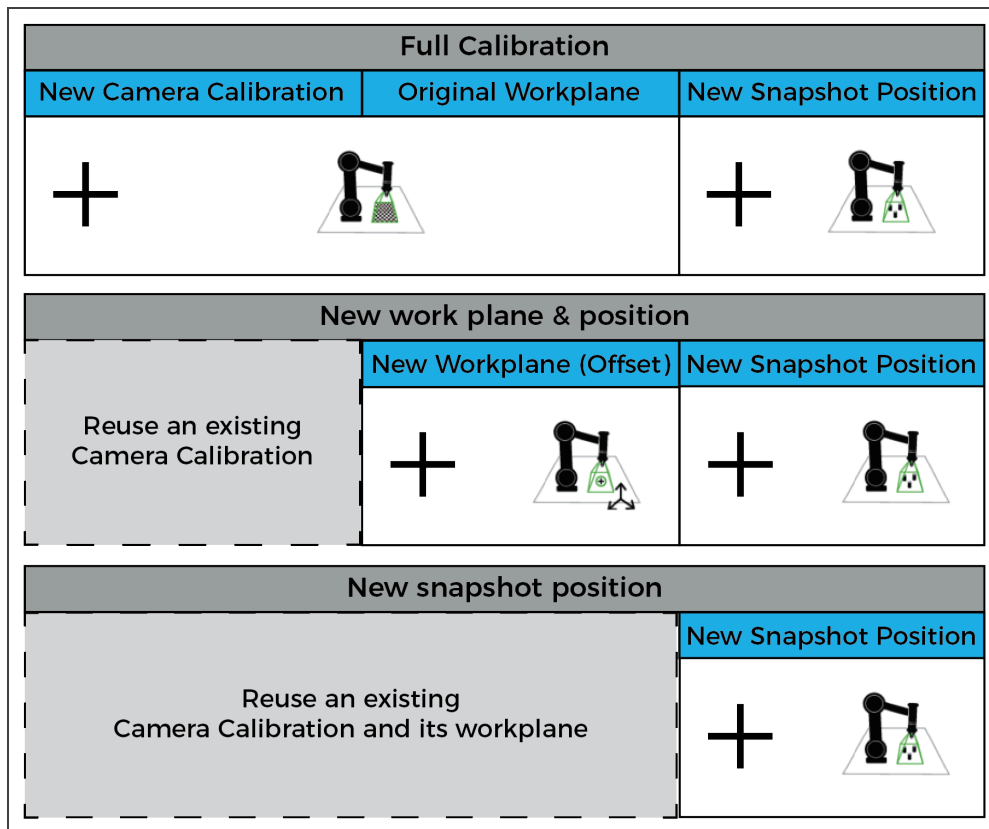

Fig. 4-5: Calibration methods summary

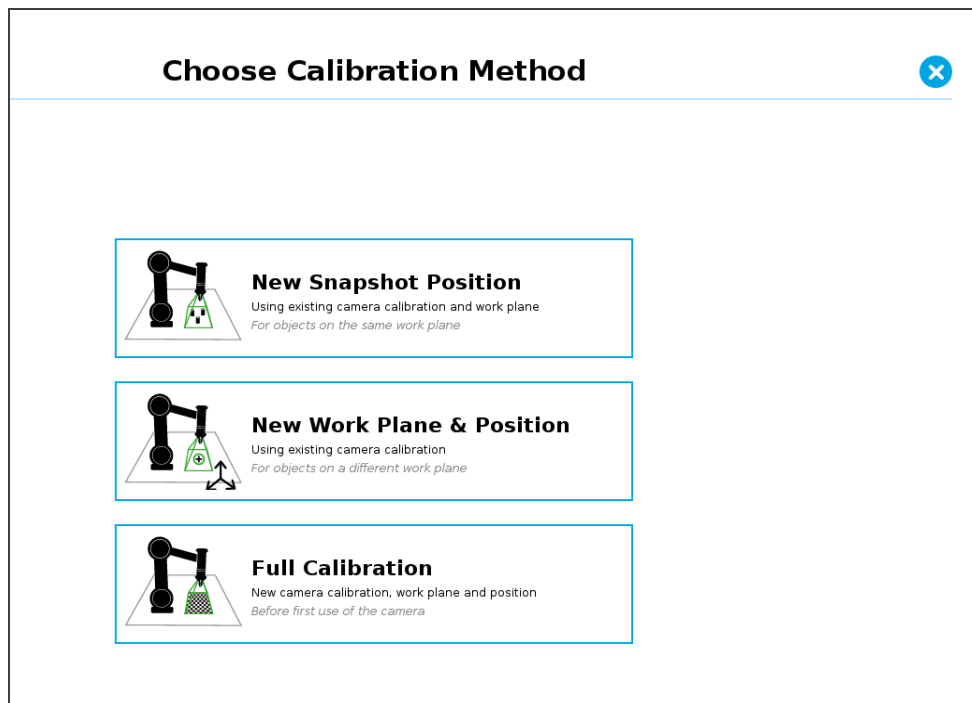

Fig. 4-6: Three calibration methods.

Caution

You first need to perform a Full Calibration. Afterwards, you will be allowed to select any calibration method.



Full calibration

The full calibration method creates a new calibration which contains the camera settings, an original workplane, as well as a snapshot position. It must be done when the camera is first installed on the robot.

New Work Plane & Position

The New Workplane and Position method can be used once a full calibration has been done. It is used to create a new workplane from an existing calibration, without having to do all the calibration process again. It creates a new calibration using the camera settings of a previous calibration. It then creates a new workplane and snapshot position associated.

New Snapshot Position

The New Snapshot position creates a new position from an existing calibration. It uses the camera settings and workplane from a previously defined calibration and simply saves a new position from which it can take a picture.

4.2.2. Full Calibration Method

1. Place the calibration board (ACC-CALIB-BOARD) on the Wrist Camera work plane. Select the appropriate side for your Universal Robots model (see figures below).

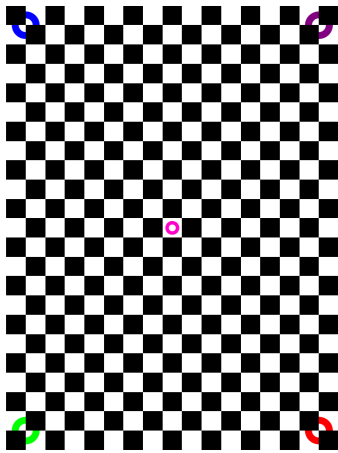

Fig. 4-7: Calibration board for UR5, UR10 and UR16 Universal Robots models



Fig. 4-8: Calibration board for UR3 Universal Robots models.

Info

Color dots are not used during the calibration process. They are handy to test the color validation of a circle if using the parametric teach method.

Info

Calibration boards can be downloaded from support.robotiq.com. Select Wrist Camera > Accessories > Calibration Boards. From the drop down list, choose either UR3 or UR5, UR10, UR16 > DOWNLOAD PDF.



Tip

To print a calibration board, follow these recommendations.

- The official Robotiq two-sided calibration board is 357 mm x 278mm. Print as "Ledger/Tabloid" or "A3" formats.
- Use matte paper.
- The calibration board can be printed with colors, gray scale or black and white.
- Do not scale the image.
- After printing, use a ruler to measure the 100 mm line located at the bottom of the page. If your measure is not exactly 100 mm, the printed document cannot be used as a calibration board.

2. The "Define Camera Calibration" window is displayed. Tap Calibrate.

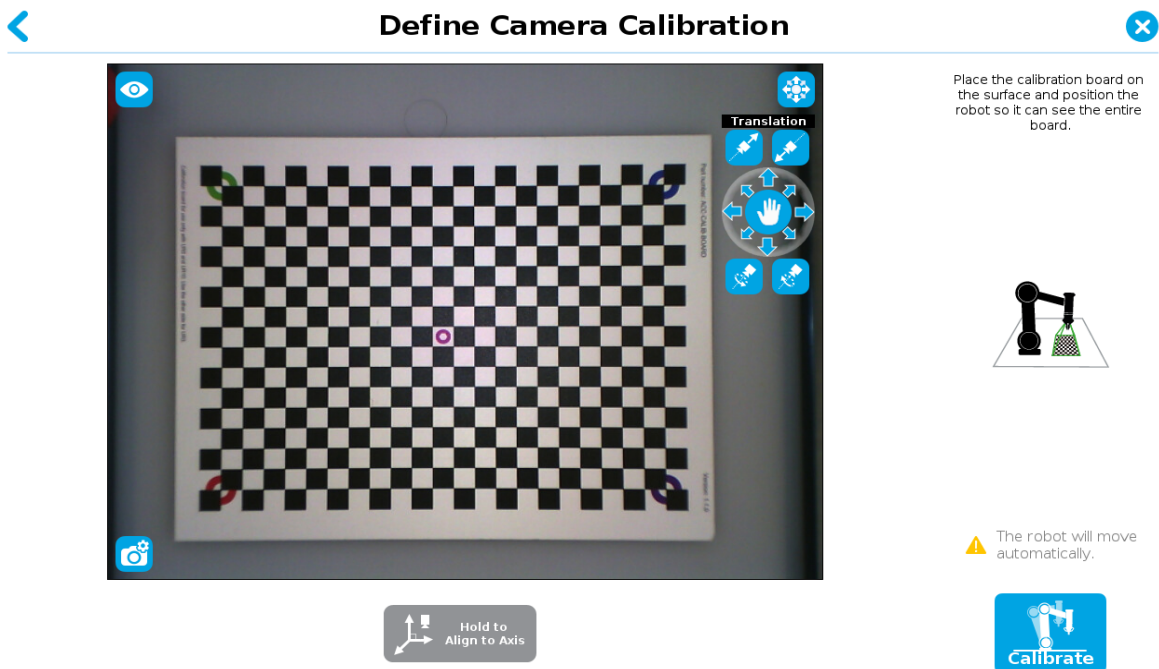
**Caution**

Move your robot so that the Wrist Camera can see the whole calibration board.





Tip

- The button Hold to Align to Axis reorientates the Wrist Camera to make it parallel to an axis of the robot base.
- The joystick can be used to easily move the Wrist Camera.

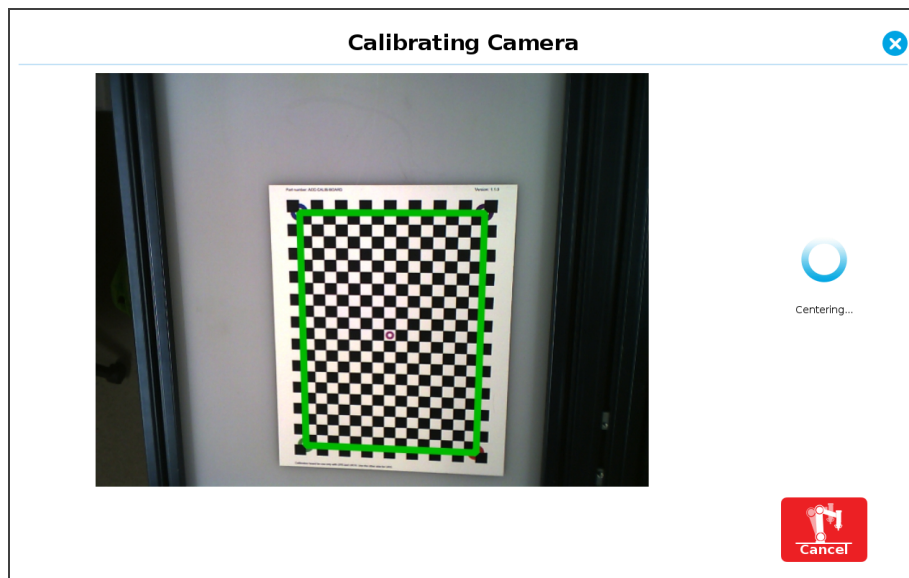
3. The "Calibrating Camera" window is displayed, and the calibration process starts. Your robot moves around the calibration board, and the Vision System will take 27 pictures of the calibration board from different poses during 7-10 minutes. Then, 9 more pictures are taken for validating.



4. The "Verify Camera Calibration" window is displayed. Tap Accept to go to the next step, or tap Re-calibrate to redo the calibration process. You can see all pictures taken during the calibration process by scrolling through them with  and .

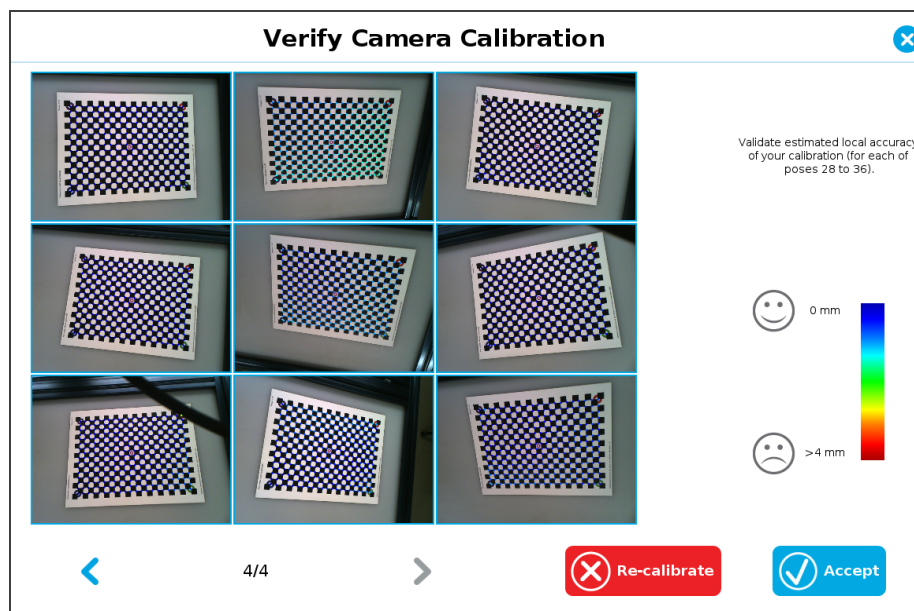

The wizard shows nine validation poses. Check the accuracy of validation poses:

- Dark blue: local accuracy of +/-0mm.
- Dark red: local accuracy of +/-4mm and over.

If the accuracy is larger than +/- 4mm, you are told that you should recalibrate. Tap Accept to complete the calibration process.

5. The "**Define Snapshot Position**" window is displayed.

- The snapshot position represents the position and orientation of the Wrist Camera when it takes a picture. To realign the Wrist Camera, tap the **Hold to Align Over** button. It is typically easier to teach and detect objects when the Wrist Camera is aligned with the workplane.
- Toggle the grid display by tapping **Show Grid** or **Hide Grid**. Objects to be located must completely fill at least one grid square, as smaller objects are difficult to detect. You can use the joystick on the camera interface to move the camera.
- If a previous calibration already exists it is possible to import the position from another calibration. This option copies the relative position between the camera and the workplane from a different calibration and applies it to the current calibration.

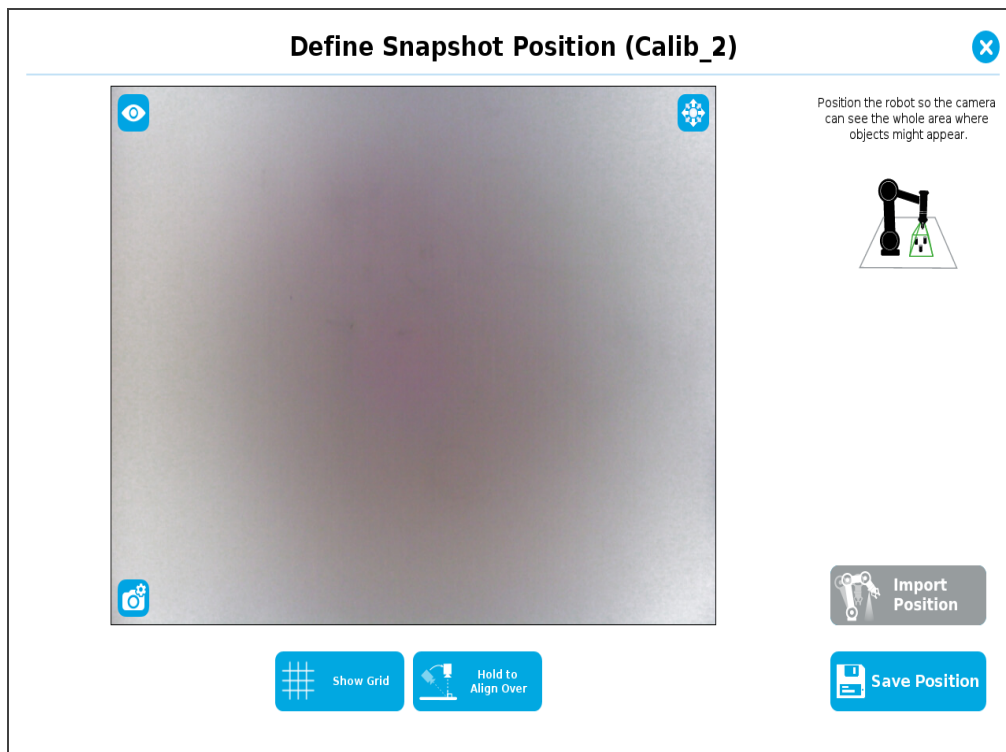

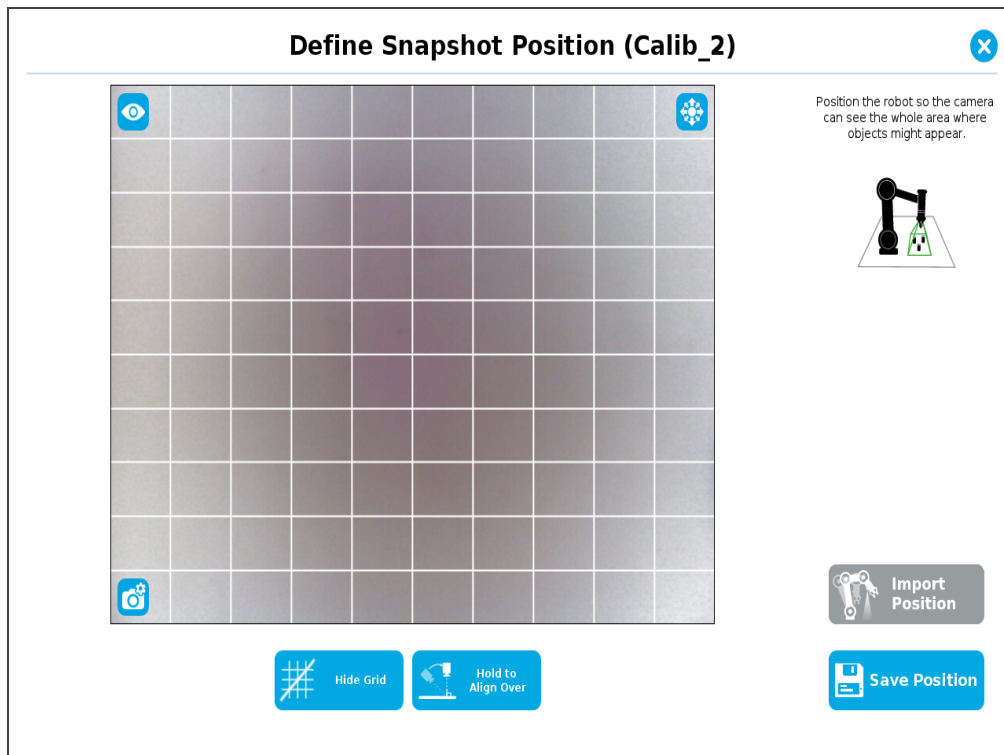

- iv. Once the calibration has been accepted, the Snapshot position appears under the **Snapshot** tab with the same name.

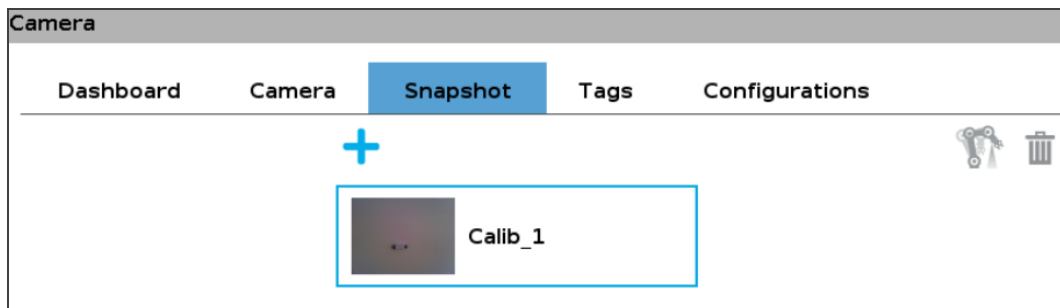

- v. To permanently save the created Snapshot position, tap Load/Save from the Installation tab, and save the **Installation** file.

- vi. To remove a Snapshot position, from the Snapshot tab, select its thumbnail, then tap  .

- vii. To move the camera to a specific Snapshot position, from the Snapshot tab, select its thumbnail, then tap  .

Info

- You can teach as many snapshot positions as required.
- The Snapshot position represents the coordinates (x, y, z) and orientation (Rx, Ry, Rz) of the Wrist Camera.
- A single Snapshot position can be used to teach different objects.



4.2.3. New Work Plane & Position Calibration Method

Once you have done at least one full calibration, you can use the **New Work Plane and Position** method. This method is used to create a new workplane where the camera can detect parts and a new snapshot position associated with this workplane. It uses the camera settings of an existing calibration.

1. Tap **New Work Plane & Position**.
2. Choose which calibration you want to start from.
3. Place the calibration board on the workplane. It must be fully visible by the camera.
4. Tap the camera button to detect the board and create a new workplane.
5. A new snapshot position needs to be defined. You can either move the camera manually (or by using the joystick) or use the **Import Position** button.
6. If the button **Import Position** is used, select the calibration from which you want to import the position.
7. Tap **Save Position** to save this new snapshot position.

Info

The **Import Position** option copies the relative position between the camera and the workplane from a different calibration and applies it to the current calibration. The camera will be moved to the same position but this time relative to the workplane that was created at step 4.

4.2.4. New Snapshot Position Calibration Method

Once you have done at least one full calibration, you can use the **New Snapshot Position** method. This method can be used to modify the position of the camera while using the same work plane and camera settings of an existing calibration.

1. Tap **New Snapshot Position**.
2. Choose which calibration you want to start from.
3. A new snapshot position needs to be defined. You can either move the camera manually (or by using the joystick) or use the **Import Position** button.
4. If the button **Import Position** is used, select the calibration from which you want to import the position.
5. Tap **Save Position** to save this new snapshot position.

Info

The **Import Position** button imports the relative position of the camera in relation to the chosen calibration workplane. It will transpose it to the workplane of the first calibration selected in the beginning of the procedure.



4.2.5. Guidelines on Snapshot Position

During the Snapshot position process, ambient light must be of approximately 500 lux. At run-time, this condition is not required. Snapshot position used for teaching objects may be different than the one used in production. However, camera angles and distances should be similar.

For example, conveyor areas are often hard to reach, causing object scanning issues. You can use a convenient area for object model teaching that will allow easy scanning. It is always possible to modify the final light and threshold adjustments at the runtime area. Set as True the variable `ignore_snapshot_position`.

For best results when choosing your Snapshot position, follow these recommendations:

- Work plane
 - Mostly uniform color
 - Flat
 - Contrasts your part. For details, see **Vision System Specifications** section.
- Distance to work plane
 - Your Snapshot position determines the field of view of the Wrist Camera, and thus, the work plane.
 - For details on field of view and parts size, see **Vision System Specifications** section.
 - Moving closer to the work plane reduces workspace, but makes it easier to locate smaller objects.
 - Moving away from the work plane increases workspace and widens the area where objects can be detected, but makes it more difficult to locate smaller objects.
- Wrist Camera viewing angle
 - Wrist Camera should be perpendicular to work plane.
 - Select a Snapshot position giving an overhead view of the object to locate, and setting a Snapshot position to locate objects from the side.

4.3. Object Teaching

Once the Snapshot position is defined, the operator can use the Cam Locate node within a Universal Robots program to teach an object to locate.

Requirements

- You must have completed the installation steps..
- Have in hand a few samples of the object to teach or its CAD file.



Info

- One Cam Locate node is used per model taught .
- Object teaching is linked to a Snapshot position. Changing this position will require you to reteach the object.
- The background used when teaching objects should provide a high contrast. You can use the yellow/pink background provided with the Wrist Camera. For details, see **Snapshot Position** section.

Info

During the object teaching, the ambient light must be approximately 500 lux, and stable. At runtime, this condition is not required.

The following must be considered when going through the object teaching process :

4.3.1. For a reliable localization

- Object is quasi-flat, respecting a maximum ratio of 1:1 between its height and its smallest dimension; see section **Vision System Specifications** for more details.
- Top surface is mostly flat.
- Object has a distinctive shape (highly contrasts the background, is asymmetrical) and distinctive features (e.g. holes, drawings, contrasting colors).
- Object has a matte finish.
- Object is not translucent.

Tip

When teaching reflective objects, turn off LED to avoid bright, contrasting spots.

4.3.2. Choosing the appropriate background

- Workplane around the object must be planar, mostly uniform and clear of any other objects.
 - At runtime, workspace conditions can change. The object detection threshold can be used to adjust detection settings according to those conditions; refer to the **Detection thresholds and scores** section for details.
- The background around the object must be a uniform, continuous shape in a single color.

Caution

For the Vision System, white, gray and black are all gradients of gray. Avoid using a black background to teach metal objects. The model would be a pale gray object on a dark gray background, and would therefore result in errors.

The Machine edge view feature shows edges seen by the Vision System in grayscale format. See **Teach Object Wizard** section for more details. See section **Vision System Specifications** for specifications on color contrast.



Tip

Runtime tips:

- Use a simple, uniform background.
- Your work plane should contain as few objects and object types as possible. This will decrease cycle time.
- Ambient light should be diffuse.
- Avoid high contrast light spots on your background. Light spots make object detection slower, and cause errors.

4.4. Teach Object Wizard

To insert a Cam Locate node in the robot program, follow these instructions.

CB-Series models

1. Start a new program or open yours, then go to the **Program** tab.
2. Tap the **Structure** tab > URCaps > Cam Locate.

e-Series models

1. From the ribbon, tap **New** icon to create a robot program, or **Open** to load a program.
2. Select **Program**.
3. From the left Navigation pane, tap **URCaps**.
4. Tap **Cam Locate**.

4.4.1. Launching the Teach Object Wizard

Info

Snapshot position must be defined prior to launch in the object teaching wizard. For details, see **Snapshot Position** section.

The Teach object wizard will guide you through the process of teaching the required object. To launch the wizard, tap the **Cam Locate** node > **Command** > **Teach object**.





Fig. 4-9: The CB-Series Teach object wizard.

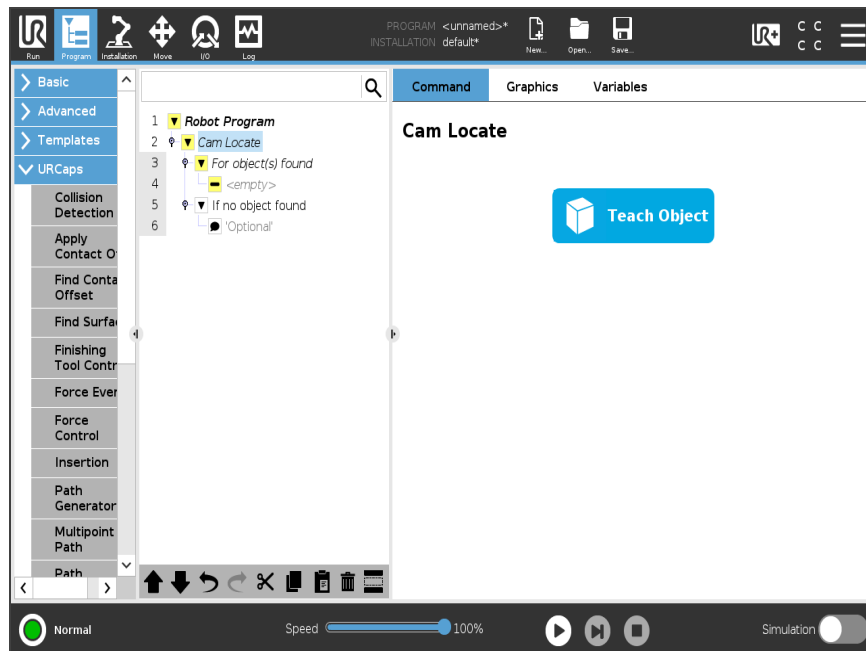

Fig. 4-10: e-Series Teach Object Cam Locate



Selecting a Calibration

Tap the **Calibration** you want to use.

Info

If the robot is not at the Snapshot position, you will be prompted to move to it. Tap and hold the **Move** button to do so.

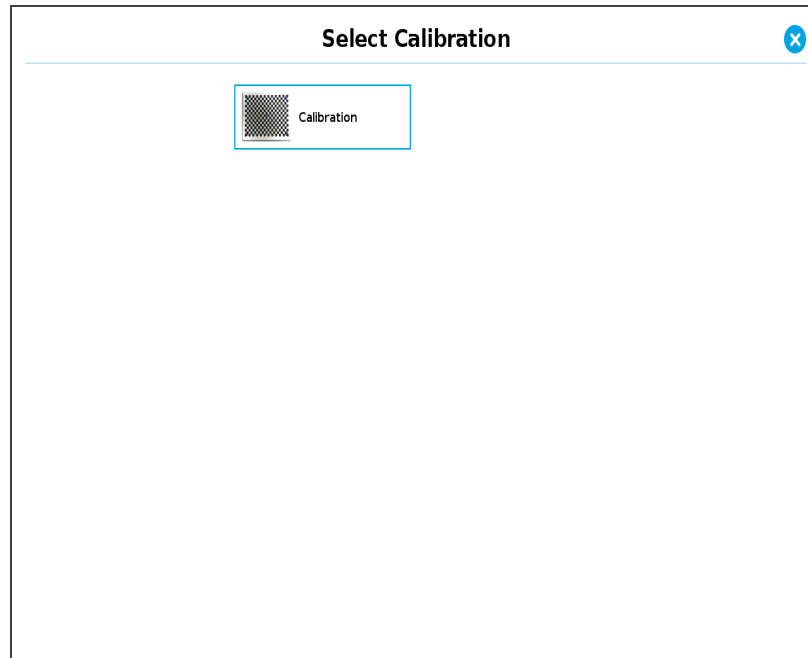

Fig. 4-11: "Select Calibration" step.

4.4.2. Selecting the Teach Method

- **Automatic method:** builds a model based on photos and a scan of the object. Best for complex and irregular shapes. Use this method if the object orientation has to be detected with one of its features.
- **Parametric method:** builds a model based on parameters of a basic 2D shape (circle, ring, square or rectangle). This method is faster and allows the vision system to recognize and locate with high robustness objects that have few distinctive features such as raw material blanks. Usually gives better results than the Automatic Method for simple objects that are highly reflective.
- **CAD Import Method:** for objects with complex or irregular shapes that are more difficult or physically impossible to scan.



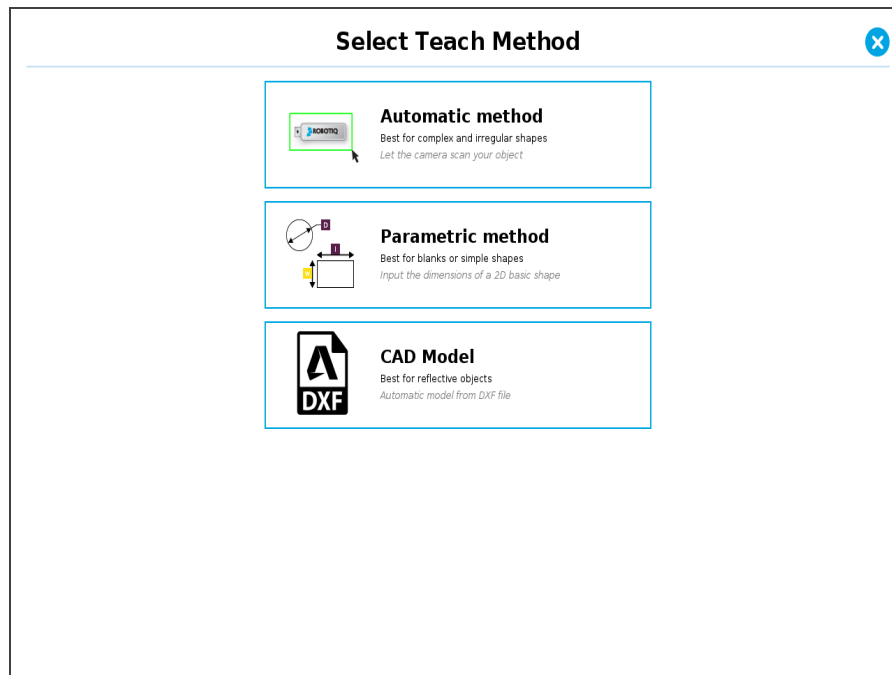

Fig. 4-12: Select the required method to teach an object.

4.4.3. Automatic Method











Caution

A Snapshot position must be defined to launch the object teaching wizard. If no Snapshot position has been defined, see **Snapshot Position** section

Selecting a Model

Prior to selecting a model, the user will place a background on the workplane and then position the object on the background. By default, the **Select Model** step displays the object to teach, automatically selected by the software, meaning a green selection rectangle overlaps the shape of the object.



	Magic Wand tool
	Tap and drag tool
	Zoom in button
	Zoom out button
	Accept model button for finalizing the model selection step
	Camera settings button
	Standard view button
	Machine edge view button
	Machine color view button
	Intensity view button

Automatic Area Selection

The object is selected since the **Magic Wand** tool is enabled by default. The Magic Wand feature allows to locate objects on the background without user intervention.



Info

For the automatic area selection feature to function properly, the user has to employ a uniform background, and a single object with well defined edges.

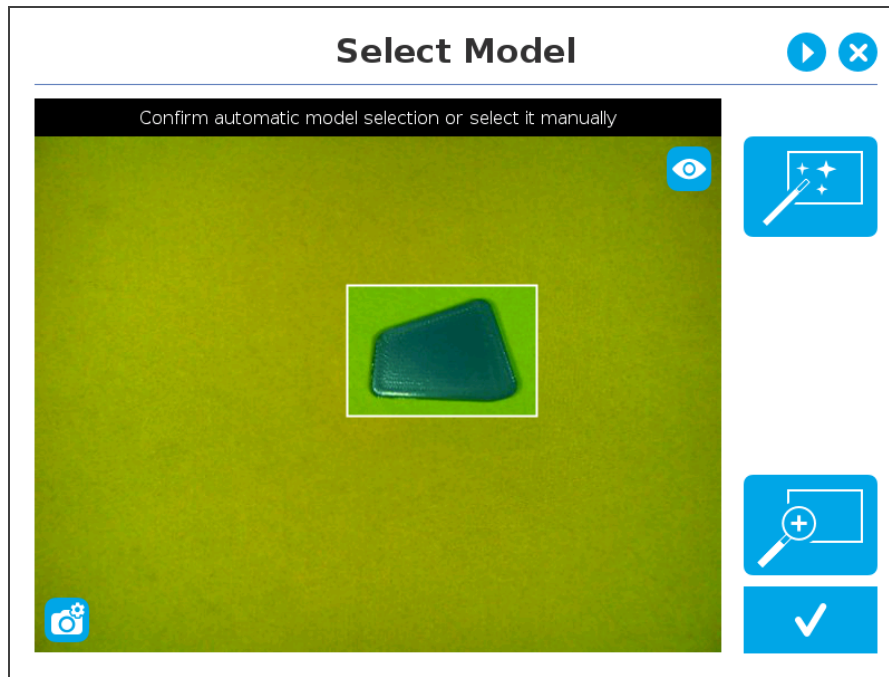

Fig. 4-13: Select Model step with object automatically selected by the Magic Wand tool.

Info

Centering an object in the field of view often provides the best edges detection.

Tip

Tapping  toggles to **Manual** area selection mode.

Tap  of the camera feed window to display all the views. Select the **Machine view** button to visualize edges detections and to optimize part location, depending on lighting setup.



Manual Area Selection

Select an area by tapping the screen and dragging your finger over the object in the selection area.

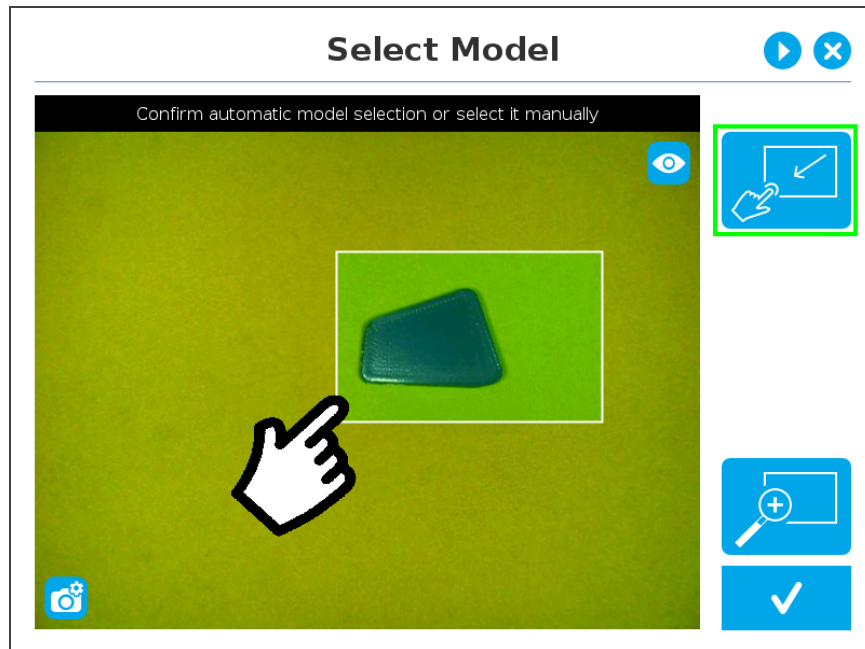

Fig. 4-14: Select Model step with Manual area selection feature

Tip

The manual area selection is useful for careful inspection of specific features using the zoom function.

The manual area selection can also be used for partial custom object selection (i.e. for selecting standalone features or components of an object).

Tapping the **Manual selection** button in the right pane toggles back to the "Automatic area selection" mode.

Camera Viewing Modes

The following viewing modes are available for the Wrist Camera:

- Standard view
- Machine Edge view
- Machine Color view
- Intensity view

Tip

Tap  of the camera feed window to display all the views.



Standard View

When in standard view mode, the camera feed displays a reasonably faithful image based on what is normally perceived by the human eye (colored object on colored background).

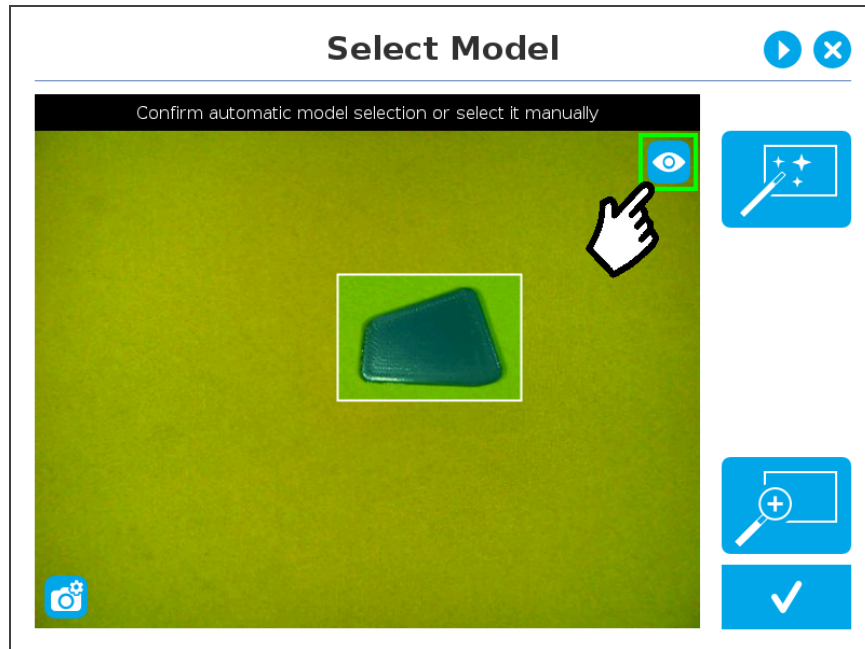

Fig. 4-15: Select Model step with standard view enabled

Machine Edge View

The machine view makes no discrimination between colors; it rather highlights the contour of the selected object.

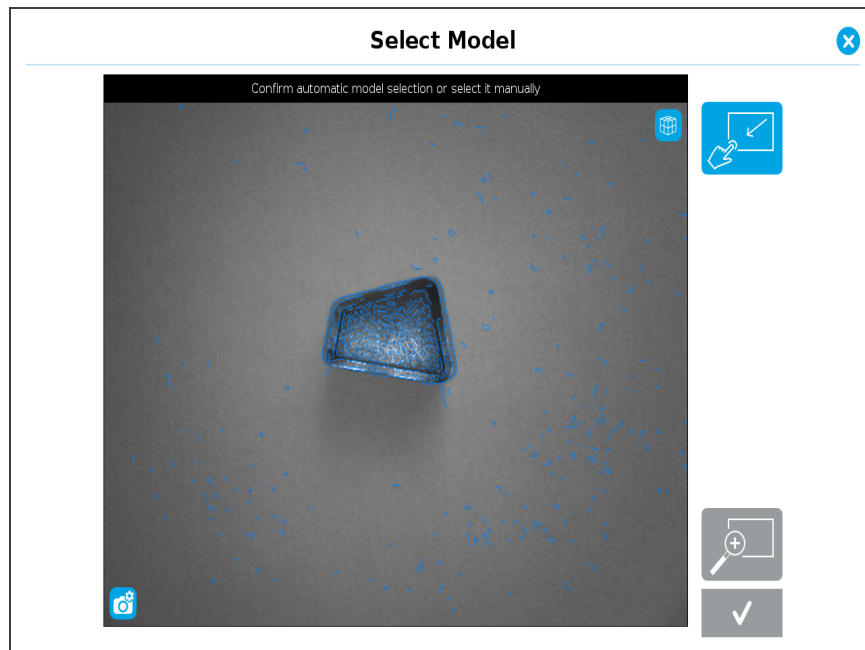

Fig. 4-16: Select Model step with Machine edge view enabled



Tip

The Machine edge view is a convenient tool that can be used to better understand the quality of the image and the object contrast, and to improve adjustments made to the selection.

Machine Color View

The Machine color view displays the elementary colors perceived by the vision system.

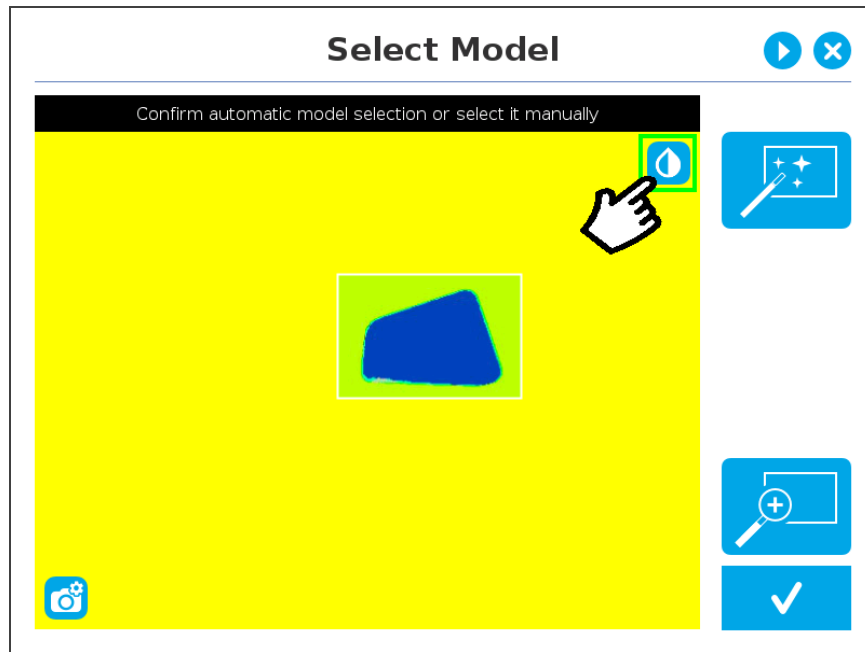

Fig. 4-17: "Select Model" step with Machine color view enabled.

Tip

The Machine color view helps to understand the color signature and scale used by the system.



Intensity view

The intensity view displays the quality of illumination and uniformity of the vision system.

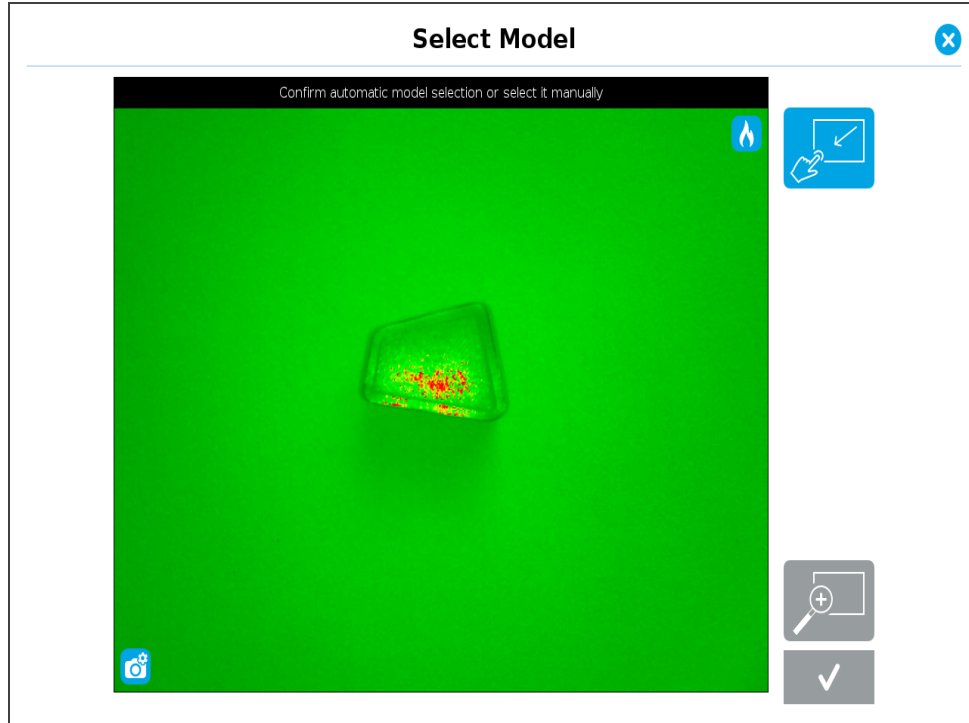











Fig. 4-18: "Select Model" step with Intensity view enabled

Camera Settings

To access advanced settings, tap  in the bottom left corner of the camera feed.

	Camera LEDs setting; see Software section for more details.
	Camera Exposure setting; see Software section for more details.
	Camera Focus setting; see Software section for more details.
	Camera White Balance setting; see White Balance section for more details.
	Camera Automatic exposure mode



	Camera Manual exposure mode
	Automatic LED mode
	Manual LED mode
	OFF LED mode
	Automatic focus mode
	Manual focus mode
	White Balance Automatic mode
	White Balance Manual mode
	Plus button increases a value.
	Minus button decreases a value.
	Reset button; the setting is reinitialized. Please refer to the specific setting section for more details



Camera LED

In addition to the **Auto** and **Off** settings, the **Manual mode** provides a Camera LED's intensity adjustment. The touch-sensitive slider can be used to select the right intensity more easily.

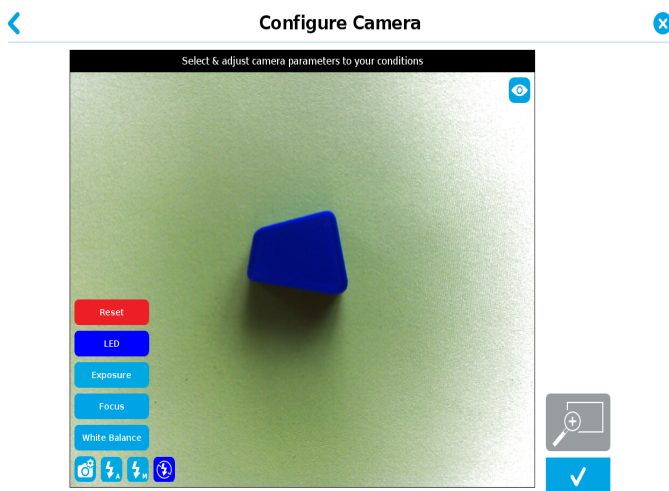
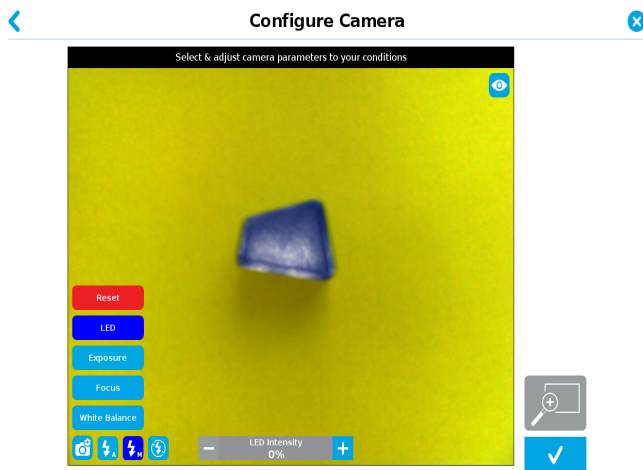
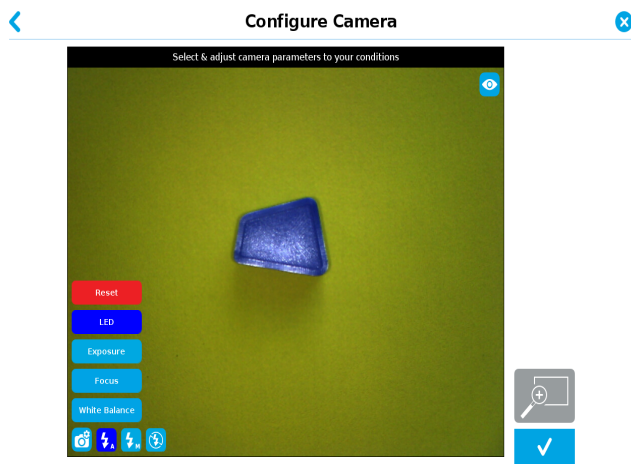

Fig. 4-19: Select Model step with LED option enabled; (a) Auto, (b) Manual, and (c) OFF



Tip

When turned ON, LED sometimes highlight undesirable features or create reflections that can mask desired features of the image. It is recommended to try multiple settings, including the ON/OFF mode, when teaching the object in order to select the most conclusive result.

Warning

The flash and focus settings selected will be used at run time unless changes are made at the **Configure Model** step at the end of the teaching process.

Please refer to the **Configure the model** section for more details.

Exposure

The exposure value (EV) can be changed using the slider to obtain the desired contrast and to avoid reflexions.

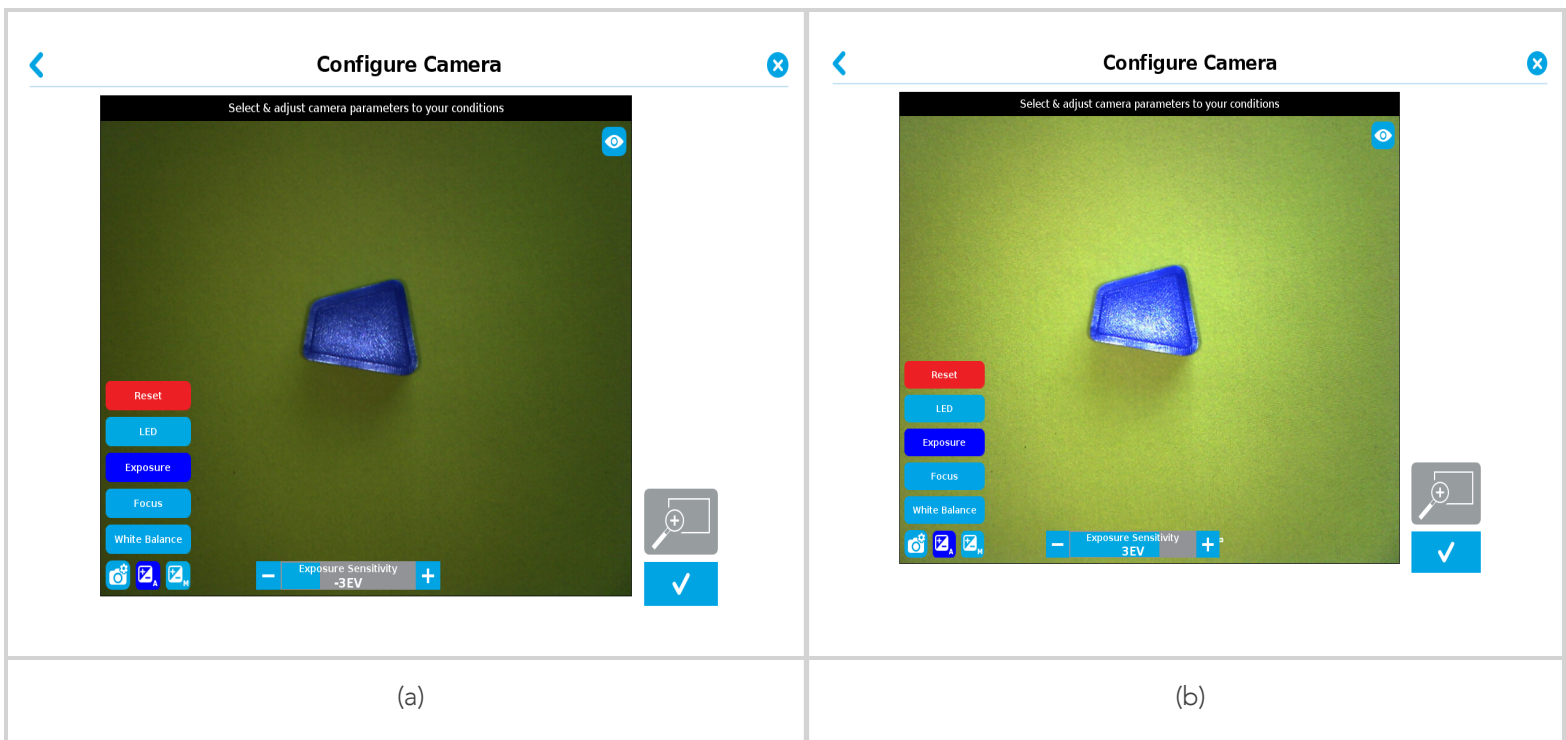

Fig. 4-20: Select Model step with Exposure option enabled; (a) -3EV and (b) 3EV

For more control, the **Manual mode** allows the user to directly modify the exposure or the gain and keep them fixed. A **Reset** button is also available in the **Manual mode**. This function enables to adjust the manual settings according to the last automatic exposure value. If the **Manual mode** is selected, the exposure time (μs) and the gain can be modified independently. The exposure time is the duration (in microsecond) of the sensor's light exposure. On the other hand, the gain represents the electrical amplification of the analog signal from the camera sensor. It converts the analog signal to a digital signal. It should be noted that the amplification of the signal also increases the ambient noise.



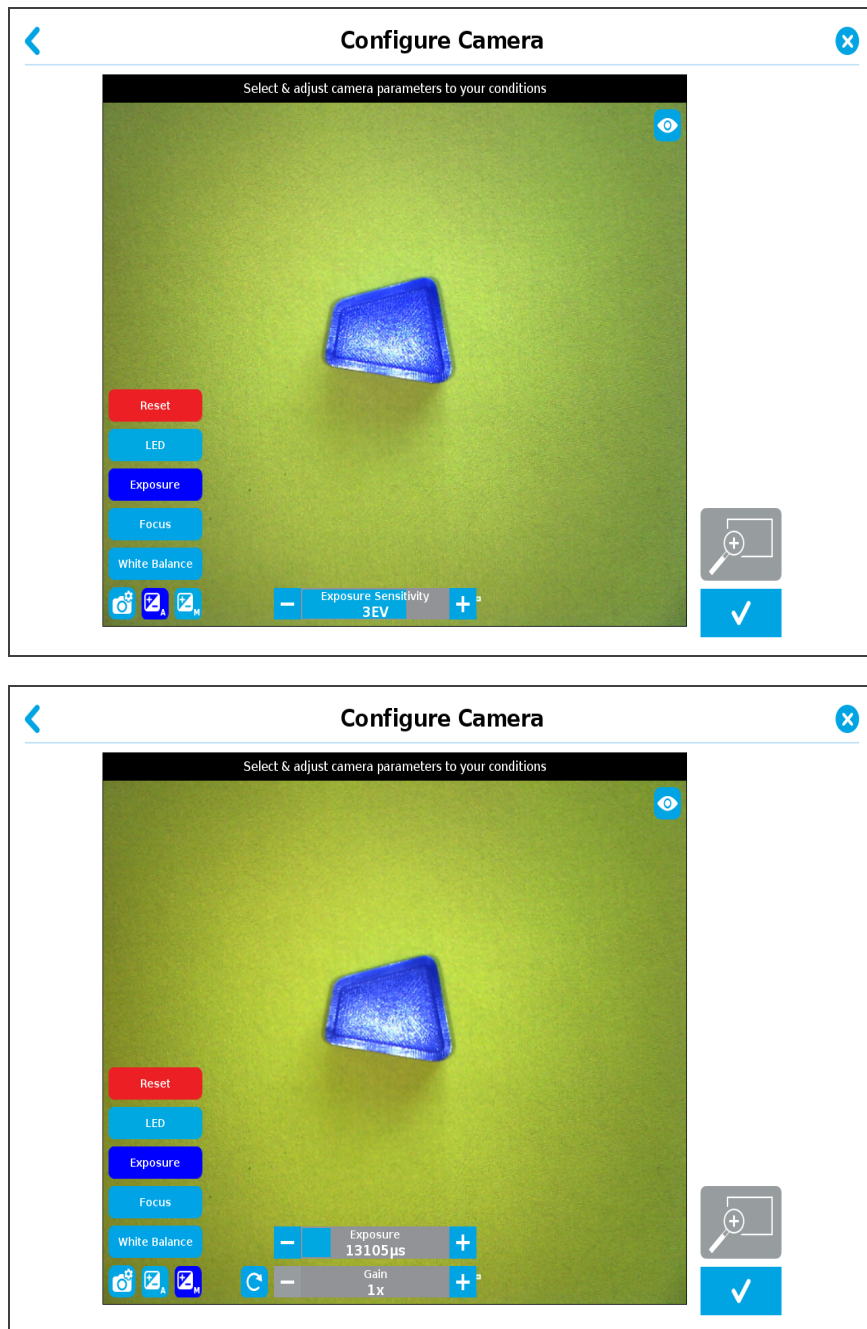

Fig. 4-21: Select Model step with Exposure option enabled (Automatic and Manual modes enabled)

It is possible to reduce or eliminate camera image flicker (also seen as vertical moving bands) by matching camera exposure time with illumination frequency. See the following table to match exposure time and current frequency (50/60Hz).



Exposure time (ms)		
Category	50 Hz	60 Hz
Short Exposure	10.0	8.333
	20.0	16.667
Medium Exposure	30.0	25.0
	40.0	33.333
Long Exposure	50.0	41.667
	60.0	50.0
	N/A	58.333

Table 4-1: Suggested Exposure time versus Current Frequency (Hz).

Tip

To improve image quality, it is recommended to increase exposure time before increasing gain.

Info

The exposure value (EV) represents a combination of exposure time and digital gain. Simply put, increase EV to make images brighter.

Focus

Info

Focus features can be used to sharpen or diminish the contrast between the object and the background, and adjust the depth of field. The settings will be captured at runtime except if changes are made to the model during the **Configure Model** step. See **Configure the model** section for more details.



Automatic Focus

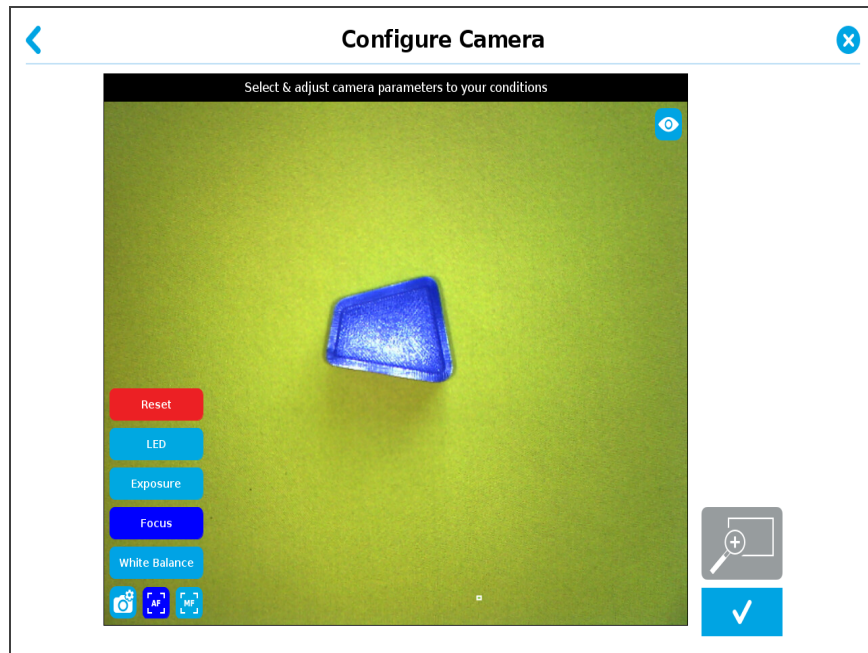

Fig. 4-22: Select Model step with automatic focus option enabled.

To some extent, the automatic focus feature detects sharpness in the overall image. If the image is blurry, the autofocus system will adjust the focus until sharpness and/or contrast is achieved. This type of automatic focus requires enough contrast between the object and the background for it to render an appropriate image.

Manual Focus

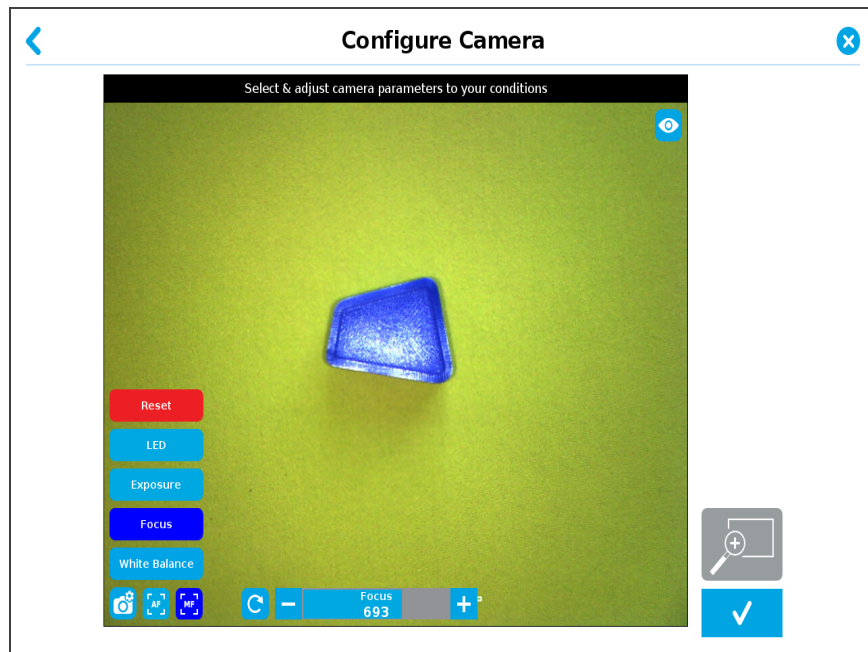

Fig. 4-23: Select Model step with manual focus option enabled

By clicking on the manual button, the **Manual focus** feature adjusts the depth of field at the focus point.

By clicking on the **Retake** button, the system refreshes the focus to the optimal result.



Tip

The Focus adjustment slider is touch-sensitive. The position touched on the the slider area will determine the desired value. For finest possible adjustment, the +/- buttons can be used.

White Balance

White Balance is a parameter to get appropriate colors and better-defined shades of grey. It is always in Automatic but manual setting can be done by clicking on the Manual button. In this mode, three sliders, each representing a different color (red, green, blue) are available to adjust the level of their own color.

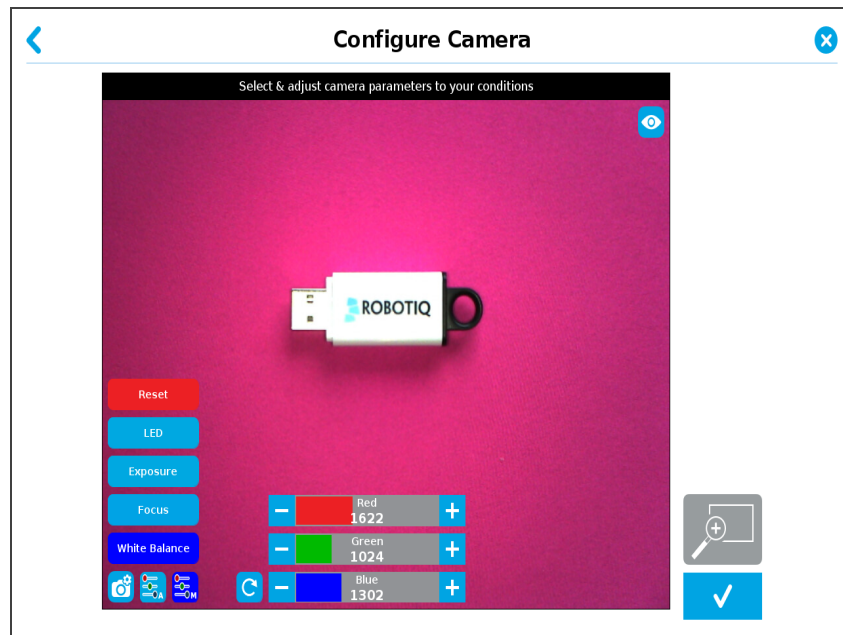

Fig. 4-24: Select Model step with White Balance option enabled (Manual mode enabled)

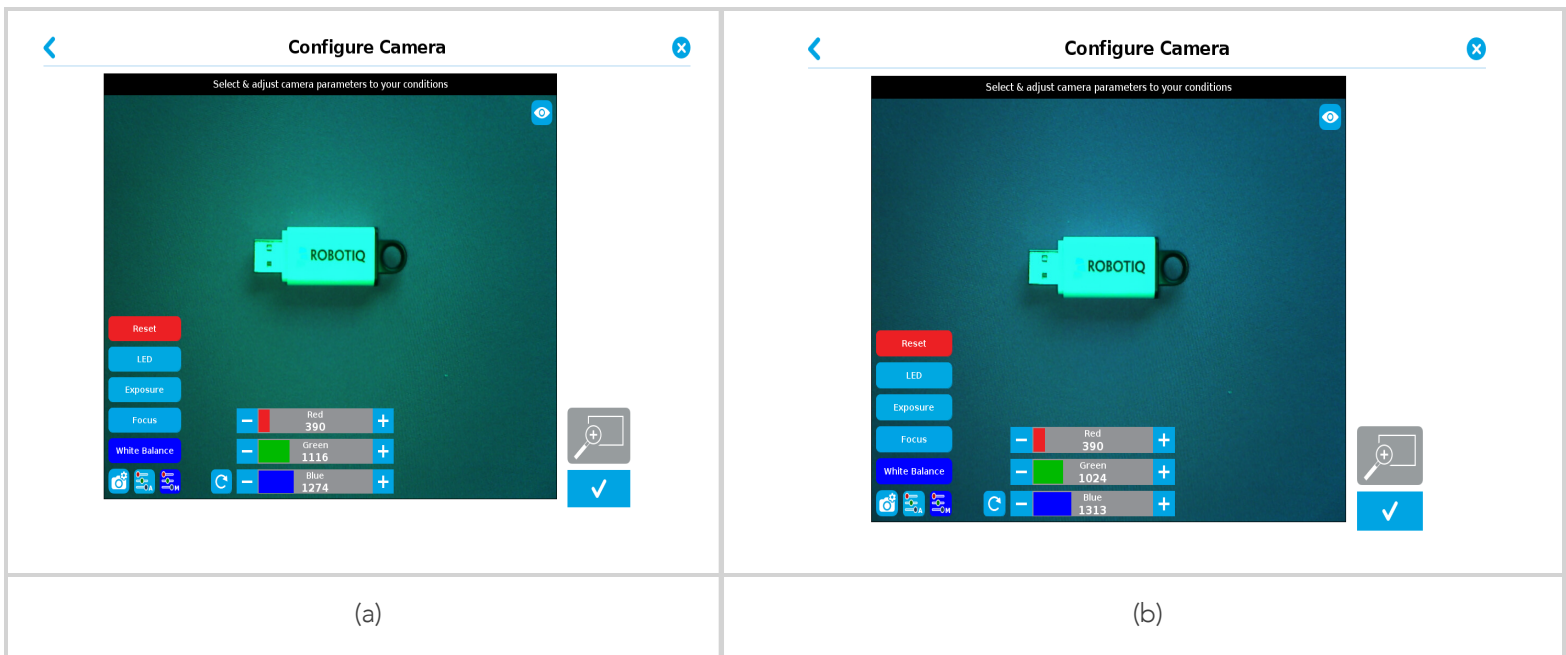

Fig. 4-25: White Balance configured with (a) less red color and more green (b) less red only



Tip

When teaching metallic objects, using the pink mat will increase the contrast between the part and the background. Reduce the red channel and increase the green one to optimize the contrast of a shiny metallic object. Use the Machine View to adjust these parameters.

Zoom

The zoom-in/zoom-out tool is used to toggle between a high-level view and a more explicit view of the selection area (and object).

Zooming In

Fig. 4-26: Select Model step with Zoom in button highlighted

In order to zoom in on the selection area, the user has to tap the magnifier with a plus symbol in the lower right corner of the teach pendant interface.

Once zoomed in, the user can perform focus adjustments to improve the recognition of edges in the model.

Info

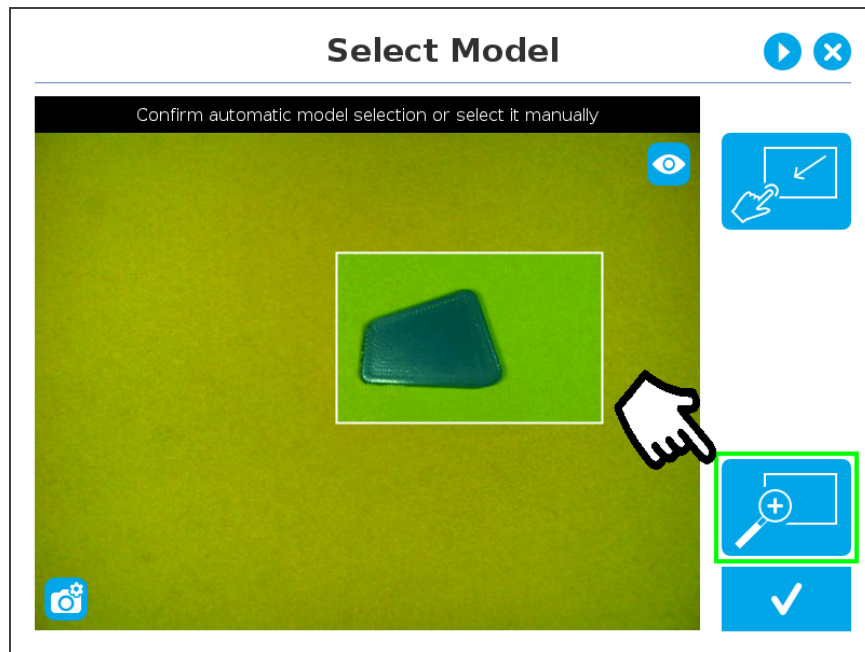
Note that when zoomed in, the user can neither change the area selection mode nor accept the model selected (the buttons are greyed out). The zoom in feature is therefore solely used for inspecting the model in details and for adjusting the depth of field via the manual focus settings.



Zooming out

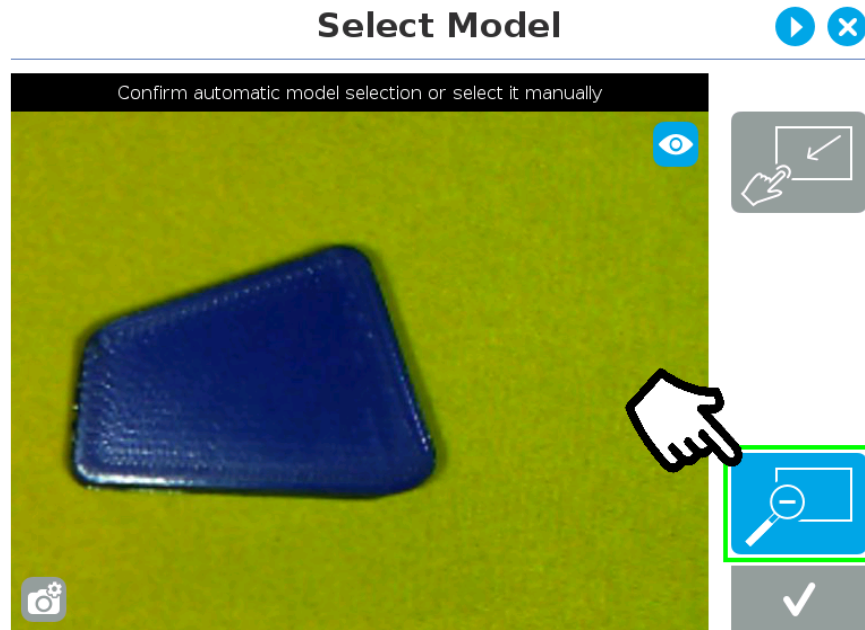



Fig. 4-27: Select Model step with Zoom out button highlighted

In order to zoom out from the selection area, the user has to tap the magnifier with a minus symbol in the lower right corner of the teach pendant interface.

Accepting the model

To accept the model, and proceed to the next step of the wizard, tap .

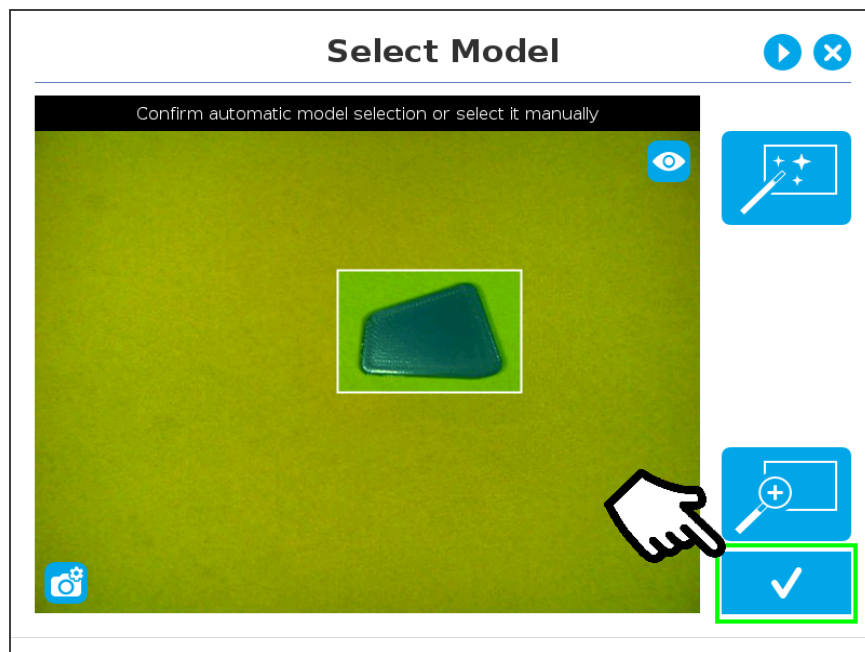



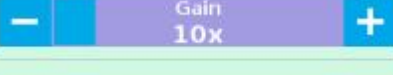













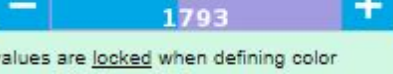



Fig. 4-28: Select Model step with Accept button highlighted









Summary of Camera Settings

Parameters		Adjustment		Range
Exposure		Sensitivity		-7...0...+7 
		Time		0...66,604 μ s 
		Sensor Gain		1x ... 63x 
		Manual Trigger		Uses active Auto Sensitivity Setting
Focus		Automatic		
		Manual		0...1023 
		Manual Trigger		
LED		Automatic		
		Off		
		Manual		0...100% 0%: min. val. 
White Balance		Automatic		
			Manual: Red, Green & Blue (RGB)	0...4095 3x   
			Manual Trigger	



Editing the Model

After accepting a model, the camera automatically zooms in on selected object . Tools are available.

	<p>Outline only selection mode; please refer to the Software section for more details.</p>
	<p>Outline & surface selection model please refer to the Software section for more details.</p>
	<p>Rectangle selection around object please refer to the Software section for more details.</p>
	<p>Marker tool; please refer to the Software section for more details.</p>
	<p>Eraser tool; please refer to the Software section for more details.</p>
	<p>Rectangle+ (add area) tool; please refer to the Software section for more details.</p>
	<p>Accept model button; please refer to the Accepting the model section for more details.</p>
	<p>Delete selection area button; please refer to the Accepting the model section for more details.</p>



Info

For details on toggling color/machine view while editing a model, see **Software** section

Quick Selection Modes

Tap the arrow to the left of the quick selection tool to expand the selection modes menu.

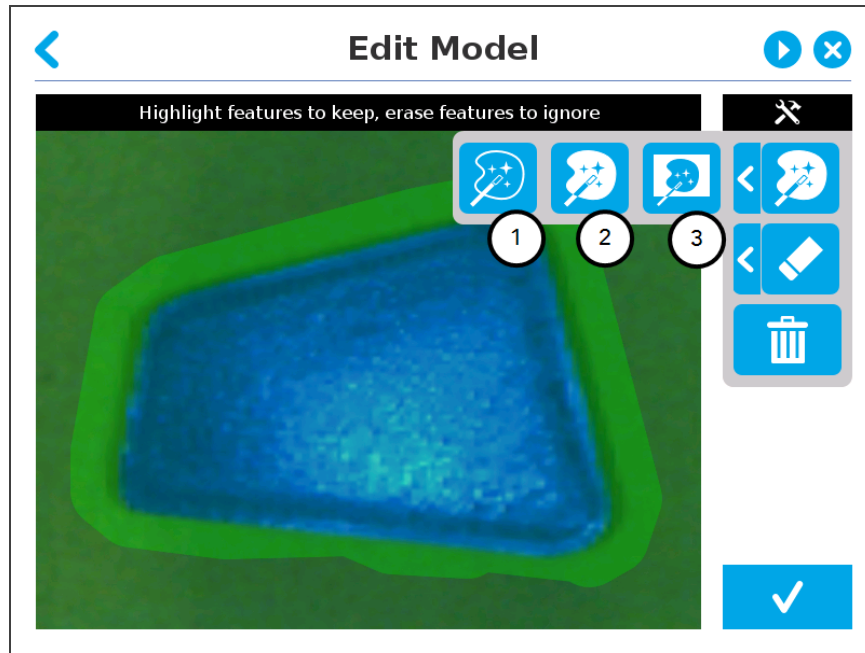

Fig. 4-29: Edit Model step with quick selection modes expanded.

1. Outline only

The Outline only selection tool is used to highlight the contour of the object. The selection area bleeds off the edge of the object to capture the background color. The **Outline only** selection tool is not available for an object that has been selected manually at the "Select Model" step. This prevents users from selecting the partial contour of an object, which could lead to faulty contrasts and edge detection.

2. Outline & surface

The Outline & surface selection tool is used to highlight the contour and upper surface of the object. Tap the middle button. This tool is selected by default when the user accepts a model selected automatically during the Select Model step. The selection area bleeds off the edge of the object to capture the background color. The **Outline & surface** selection tool is not available for an object that has been selected manually at the "Select Model" step. This prevents users from selecting the partial outline and/or surface of an object, which could lead to faulty contrasts and edge detection.

3. Rectangle around object

The Rectangle around object selection tool generates a rectangular selection area surrounding the object. The **Rectangle around object** selection tool is automatically selected when the object has been manually selected at the "Select Model" step.



Tools

Tap the arrow to the left of the tools button to expand the tools menu.

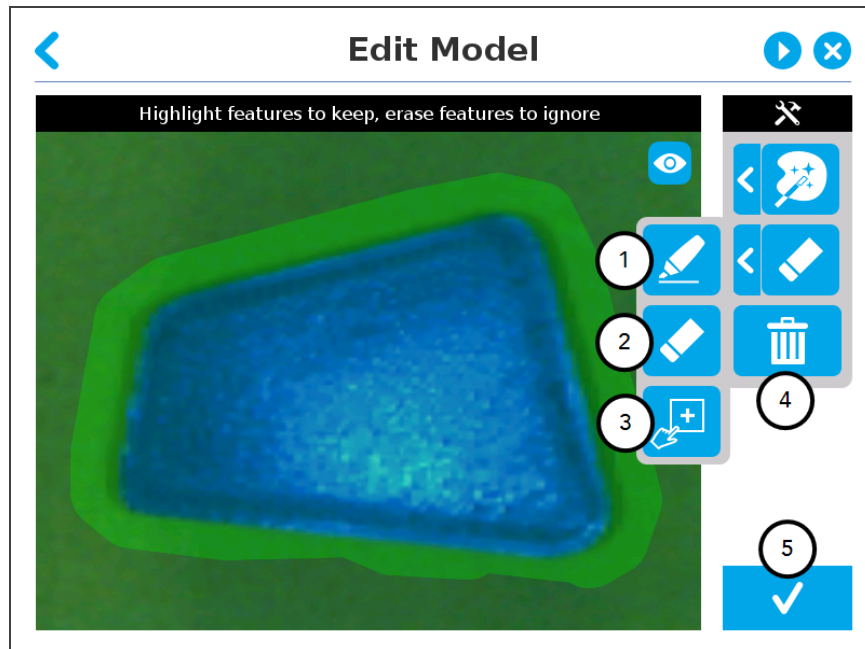

Fig. 4-30: Edit Model step with tools menu expanded

1. Marker

The marker tool can be used to highlight features and edges to **include and keep** in the selection area.

Slide your finger or pointing device on the desired area(s) on the teach pendant. A green **object layer mask** will be applied to the highlighted portion of the model.

2. Eraser

The eraser tool can be used to ignore features and edges in the selection area.

Slide your finger or pointing device on the undesired area(s) on the teach pendant. The object layer mask will be replaced by the background layer mask.

3. Rectangle+ (add area)

The rectangle+ (add area) tool can be used to quickly highlight desired areas.

Tap and drag your finger or pointing device to draw rectangular shapes that will highlight presently available features.

Deleting the Selection Area

4. Garbage can

Tap  to clear the object layer mask, thus deleting the selection area.



Accepting the model

5. Check mark

When the view of the model is satisfactory and you wish to carry on with the teaching wizard steps, tap the button with the check mark in the lower right corner of the teach pendant interface.

Caution

Tap  to take a picture of the model that will act as the first step in the next phase of the teaching process: "Refine Model".

Refining the Model

The "Refine Model" step prompts the user to take photos of the model in four different orientations. The purpose of this step is to remove shade effects associated with the edges of the object in order to refine the model.

Info

The first photo is automatically generated at the end of the Edit Model step.

Tap the camera icon to take a photo between each step. An error will pop up if the object has not been rotated.



Refine Model

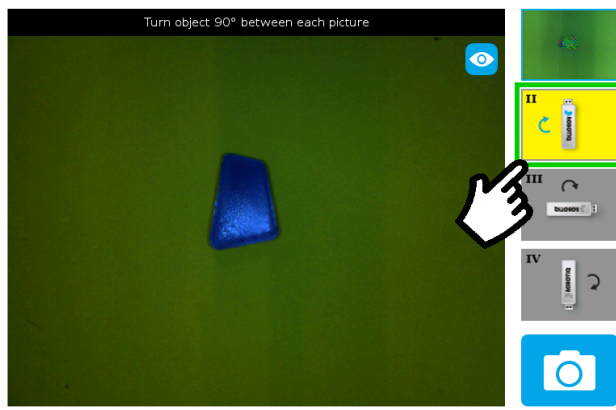

1. The user is prompted to turn the object 90 degrees clockwise. Note that the first picture is already taken, in the upper right corner.

Refine Model

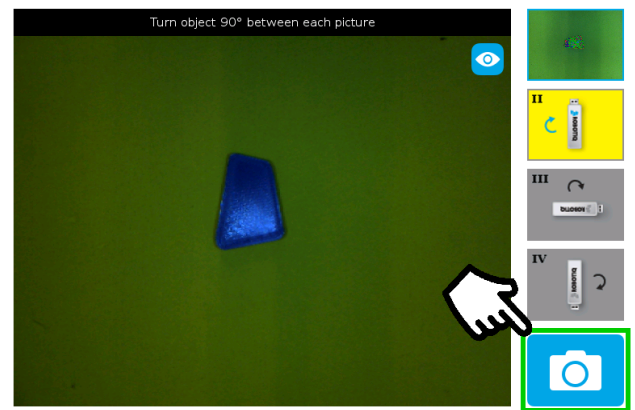

2. The user is prompted to take the second picture of the object.

Refine Model

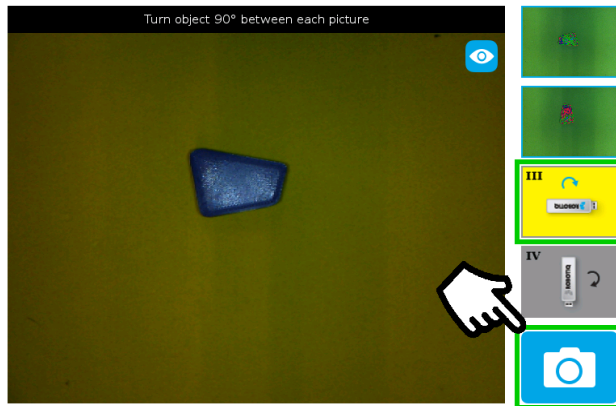

3. Object turned another 90 degrees clockwise. The user is prompted to take the third picture.

Refine Model

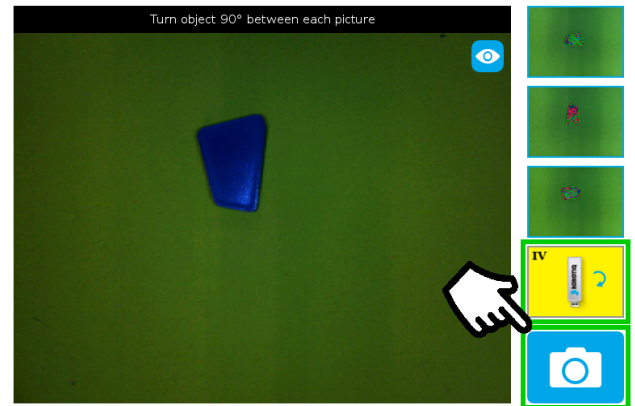

4. Object turned another 90 degrees clockwise. The user is prompted to take the fourth picture.

Tip

For best results, keep the object centered between rotations.

Tap on any snapshot taken in the object teaching wizard to enlarge it.



Validating the Model

The Validate Model step starts after the fourth picture is taken at the end of the Refine Model step.

Info

If the object is properly detected, it will display green and red outlines.
If the object has not been recognized, please refer to the **Software** section for instructions.

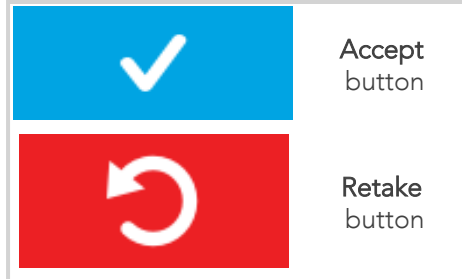

The Validate Model step is used to verify the contour selection of the model. If satisfactory, the user can accept the model by pressing the **Accept** button, or go through the Refine Model step again by tapping the **Retake** button.

Check the following:

- Object contours and detected features are outlined in green
- Features from the model that cannot be located on the object in the field of view of the camera are outlined in red.

Scanning the Model

Warning

Scanning is an automatic process; the robot will move in order to perform calibration. Make sure the robot work space is

clear. Tap  to stop the process. The operator should watch the robot at all times and have the emergency stop button at hand.



Scan button used to start the scanning process



Cancel button used to abort the scanning process while it is running



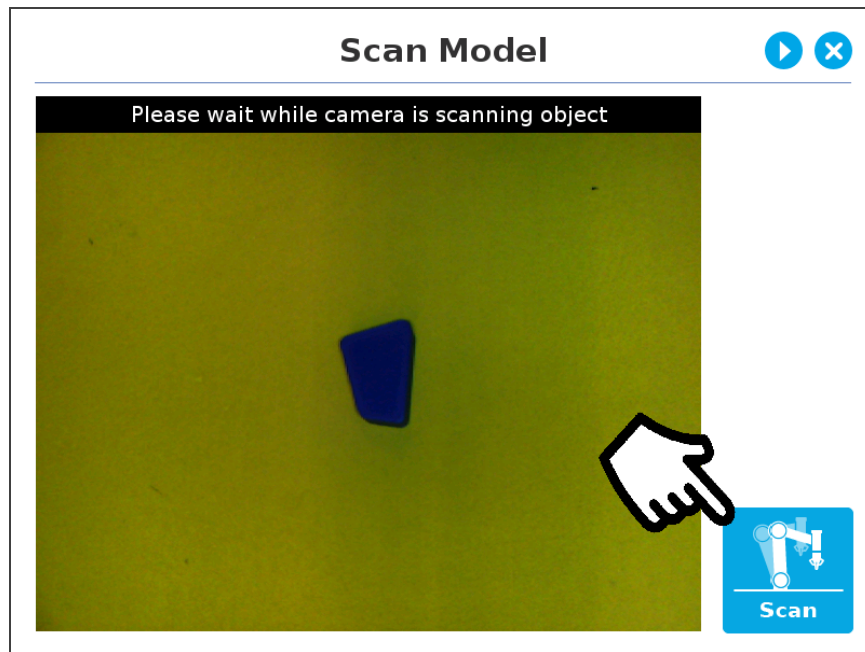

Fig. 4-31: Scan Model step with Scan button highlighted

The Vision System scans the object by taking 9 pictures.

When the process is completed, the wizard will bring up the **Configure Model** step. Please refer to the **Configure the model** section for more information.

Accepting the model

When the view of the model selected is satisfactory and you wish to carry on with the teaching wizard steps, tap the button with the **check mark** in the lower right corner of the teach pendant interface.

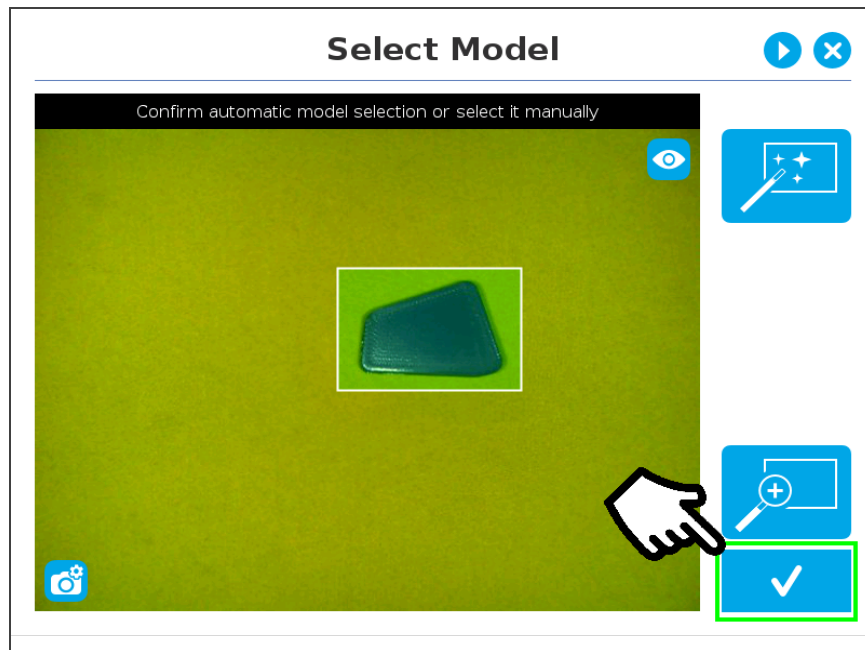

Fig. 4-32: Select Model step with Accept button highlighted



4.4.4. Parametric Method

When teaching a simple geometry object, it is recommended to use the **Parametric method**. It builds a model based on parameters of a basic 2D shape (circle, ring, square or rectangle). This method allows the vision system to recognize and locate with high robustness objects that have few distinctive features such as raw material blanks. It usually gives best results than the **Automatic method** for simple geometry and highly reflective objects.

Choose the geometry that corresponds to the object to detect and define its parameters:

- Circle
- Ring
- Rectangle
- Square

When using the Parametric method to teach an object, the Autopick functionality can accelerate building programs that use pick instructions. Autopick is only available to the Parametric method. For details, see section **Autopick**.

Info

Height (h) is the distance between work plane and a 2D shape. It considers and compensates the thickness of the provided Calibration board (~ 3mm) used to calibrate the work plane.

Caution

If you have calibrated the work plane using a printed paper Calibration Board , add 3mm to height .



Define button used to confirm the dimensions of the object.



Circle

Enter the circle diameter (D) and the height (h) at which the circle is located. Tap the **Define** button.

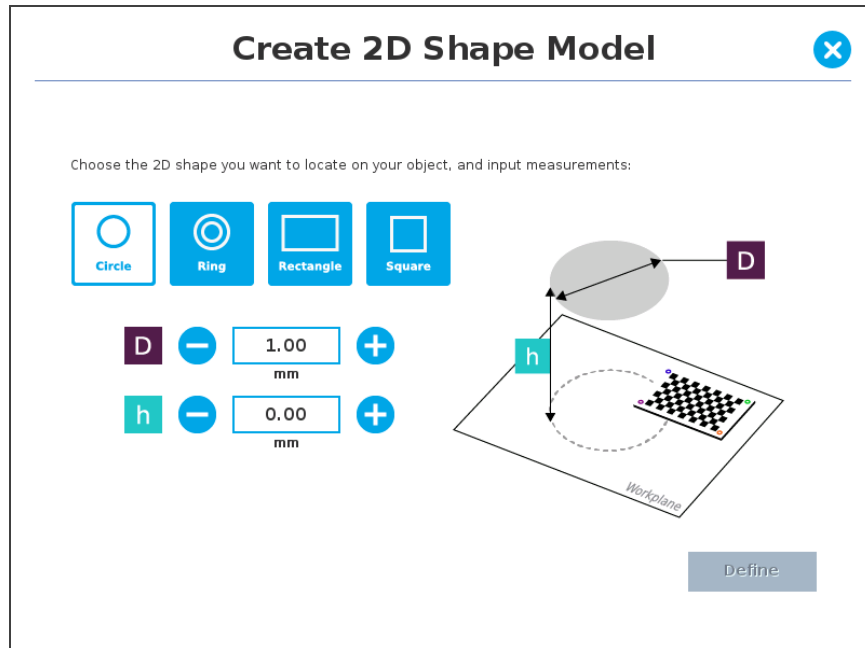

Fig. 4-33: Definition of a circle 2D shape.

Ring

Enter the ring outer diameter (D), inner diameter (d) and the height (h) at which the ring is located. Tap the **Define** button.

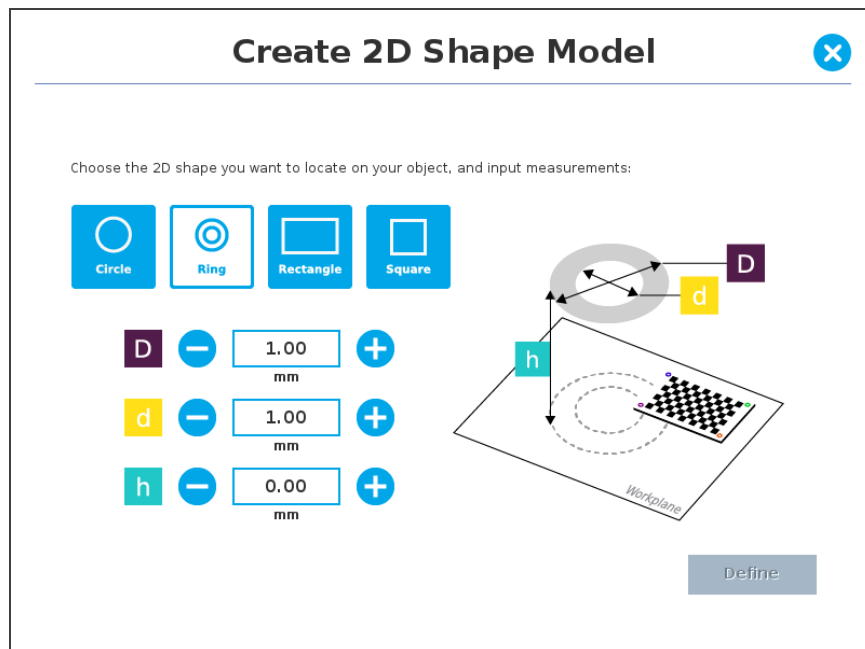

Fig. 4-34: Definition of a ring 2D shape.



Rectangle

Enter the rectangle length (l), width (w) and the height (h) at which the rectangle is located. Tap the **Define** button.

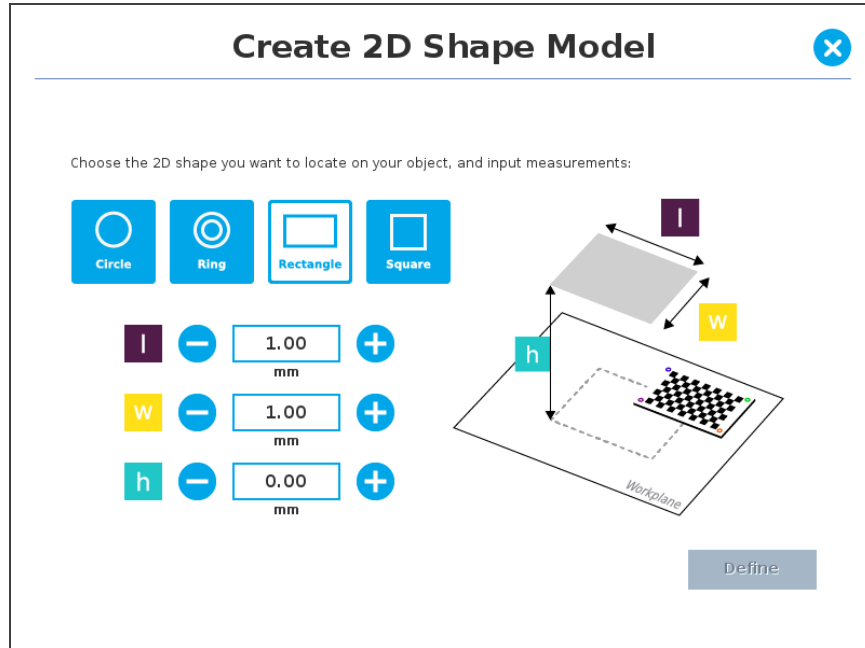

Fig. 4-35: Definition of a rectangle 2D shape.

Square

Enter the square length (l) and the height (h) at which the square is located.

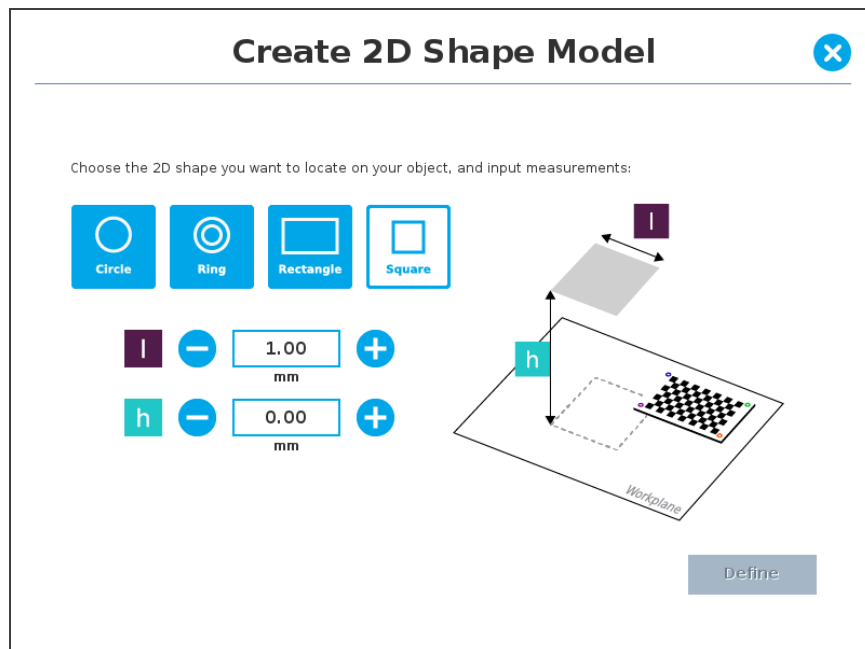

Fig. 4-36: Definition of a square 2D shape.

When the process is done, the wizard will switch to the Configure Model step. Please refer to the **Configure the model** section for more details.



4.4.5. CAD model method

1. Import the CAD model file.

Caution

Make sure that the imported file is in the DXF-R12 format.

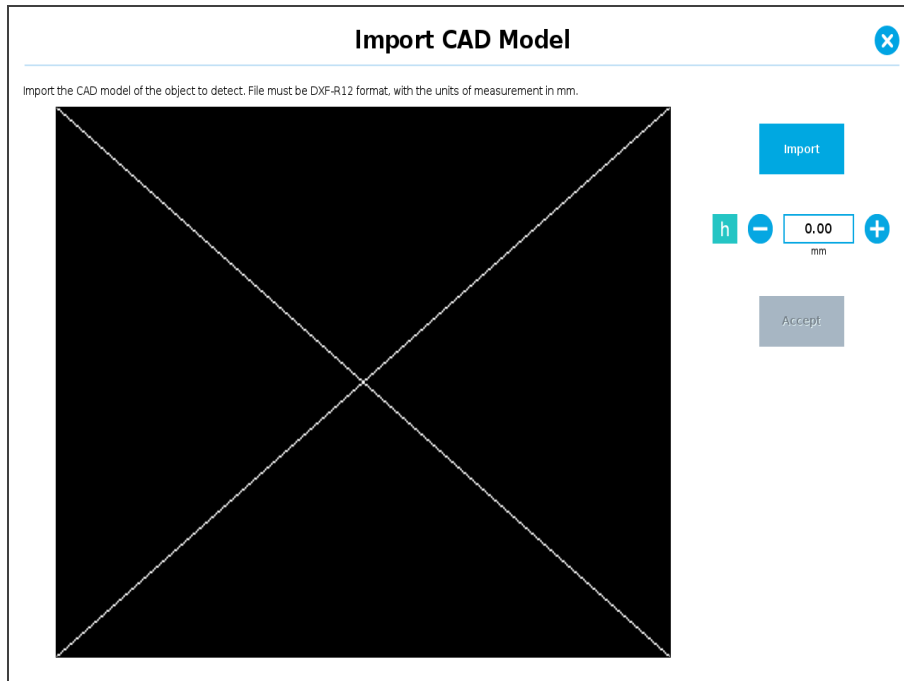

2. Click the **Import** button and select the DXF-R12 file.

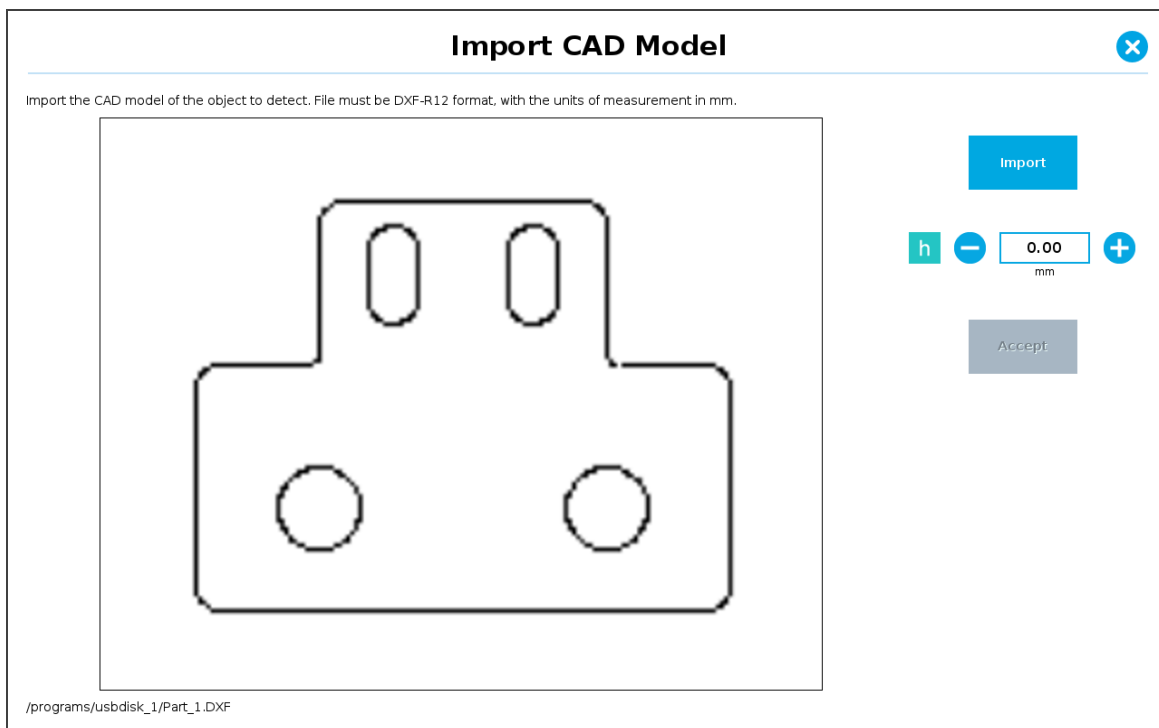

Fig. 4-37: CAD model imported



- Once the file is imported, make sure to adjust the height.

Tip

The height measure must be in mm.

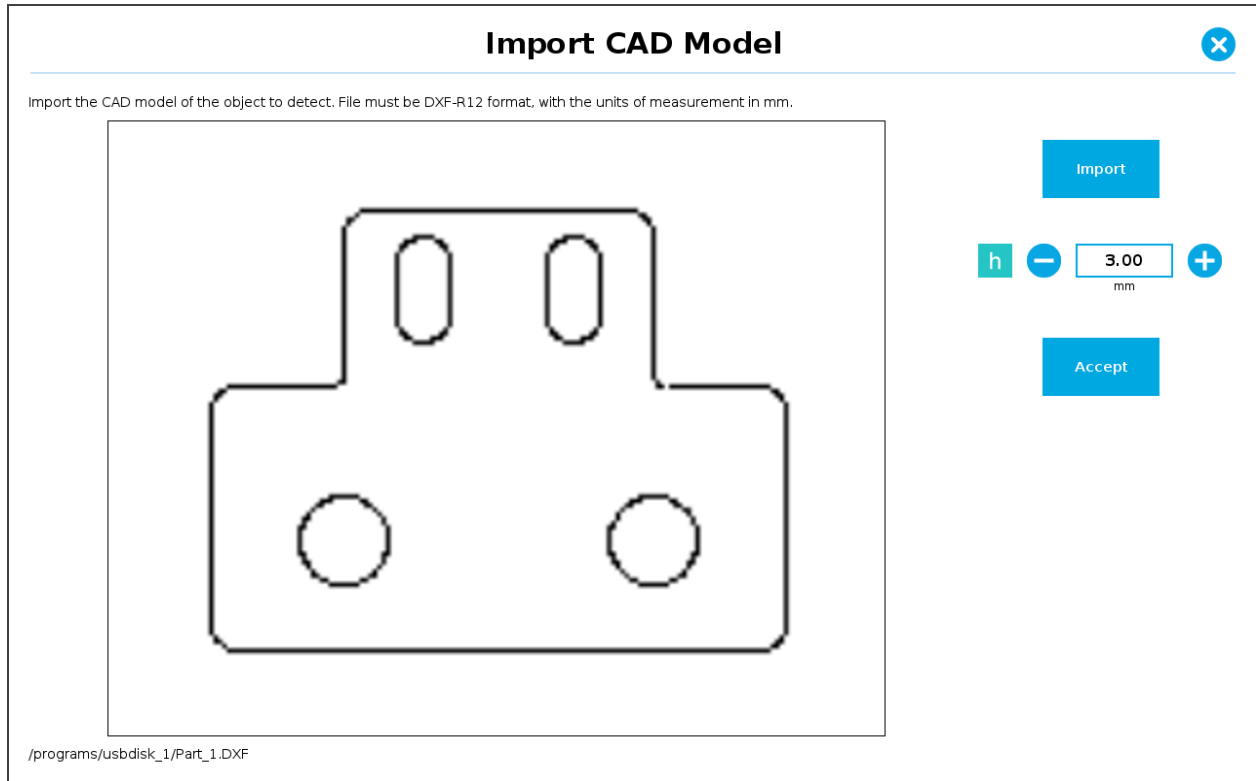













Fig. 4-38: CAD model imported with its added height



When the process is done, the wizard will switch to the **Configure Model** step. Please refer to the **Configure the model** section below for more details.



4.4.6. Configure the model

	Test locating object button; the Vision System will search for the object in the field of view of the Wrist Camera.
	Back button; after testing an object's location, tap to return to the output image of the camera.
	Color validation button; tap to open the color validation menu. A color palette button with a red cross mark indicates that the color validation mode is not defined yet or disabled.
	A color palette button with a green check mark indicates that color validation was defined and is active. Please refer to the Color Validation section for more details.
	Gripper Clearance Validation button; tap to open the Gripper Clearance Validation menu. A gripper button with a red cross mark indicates that the color validation mode has not been defined or has been disabled.
	A gripper button with a green check mark indicates that color validation was defined and is active. Please refer to the Gripper Clearance Validation section for more details.
	Multiple Object Detection button; tap to open the multi-object detection menu and set the maximum number of objects to detect.
	
	Detection Threshold button; tap to expand the detection threshold menu. Please refer to the Detection thresholds and scores section for more details.
	Minus button; tap to lower the value.
	Plus button; tap to increase the value.



	<p>Camera settings button; please refer to the Camera settings section for more details.</p>
	<p>Score value box; display section in which the detection score appears after testing the object location.</p>
	<p>Object location button; when an object is found, tap this button to view its position relative to the robot base.</p>
	<p>Set reference position button; tap to save the object's position for programming linear move (MoveL) relative to the object's location. Please refer to the Save location section for more details.</p>
	<p>Save & finish button; tap to save the detection threshold, the reference position and finish the wizard.</p>
	<p>Test/Modify button; accessible via the Command tab of the Program Robot interface in Polyscope, once the object teaching wizard is completed.</p> <p>Tap to access the Test and Modify wizard. It allows the user to modify the detection threshold and the saved object position.</p>
	<p>Set position button; accessible via the Command tab of the Program Robot interface in Polyscope, once the Teach object wizard is completed.</p> <p>Tap to re-define a new reference position for the programming linear move (MoveL) relative to the object's location.</p>
	<p>Snapshot position button; accessible via the Command tab of the Program Robot interface in Polyscope, once the Teach object wizard is completed.</p> <p>Press and hold the Move button to move the camera directly to the Snapshot position .</p> <p>When grayed out, it indicates that the camera is at the Snapshot position.</p>
	<p>Ignore snapshot position button; accessible via the Command tab of the Program Robot interface in Polyscope, once the Teach object wizard is completed.</p> <p>When selecting Test/Edit CamLocate node under the Command tab, if Camera is not at Snapshot Position, you either Move there OR stay and Ignore snapshot position.</p>
	<p>Reset button; accessible via the Command tab of the Program Robot interface in PolyScope, once the Teach object wizard is completed. Tap to reset the whole process of the object teaching wizard.</p>

Detecting Multiple Objects

From the "Configure Model" window, tap  (4).

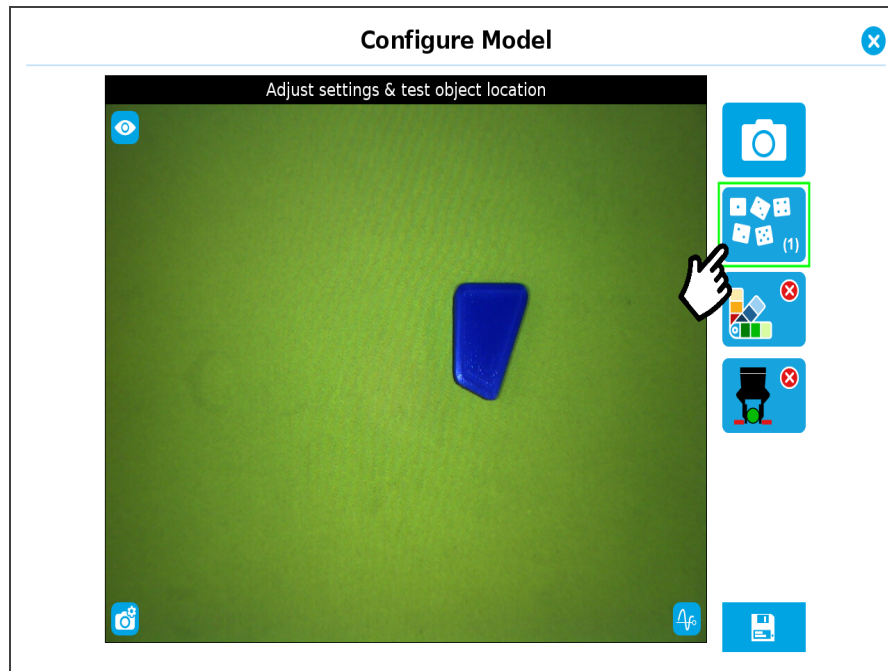

Fig. 4-39: Configure Model with multi-object button highlighted.

Once in the multi-object menu, tap the plus (+) symbol to increase the maximum number of objects to detect, or tap the minus (-) symbol to reduce that number.

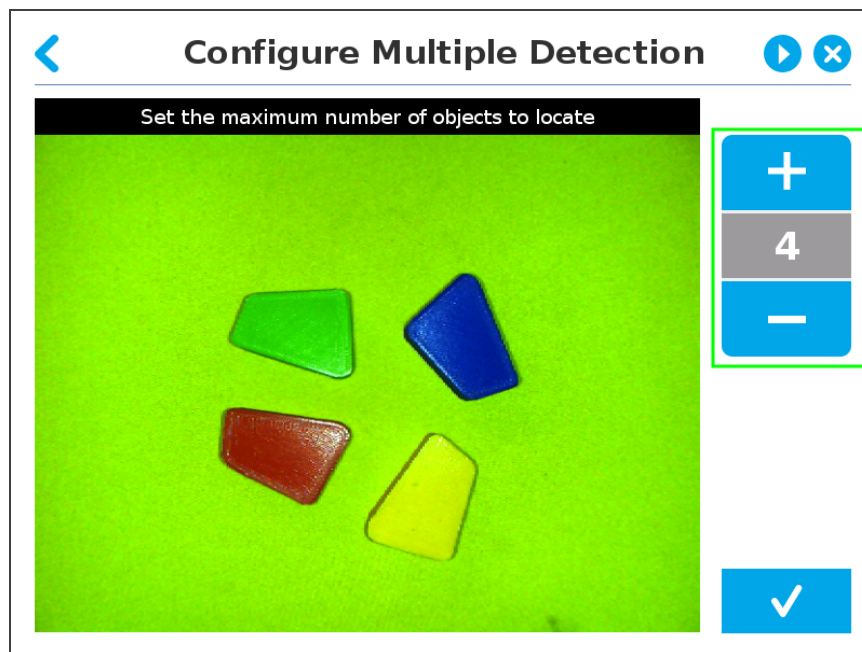

Fig. 4-40: Configure Multiple Detection menu.



Color Validation

Color validation adds reliability to the Cam Locate functionality.

Whereas editing the model allows to select, configure and save the shape, outline and area of the model, the color validation allows the system to save the color signature of objects or features.

Warning

Color validation is not intended for discriminating between two colors in the same Cam Locate node, no matter what the purpose is. However, this action can be performed and programmed with two or more Cam Locate nodes in the same program tree.

Color validation is not intended for eliminating all colors but one in a Cam Locate node, no matter what the purpose is.

Automatic and CAD model methods

1. Tap the color validation button to access the color validation menu.

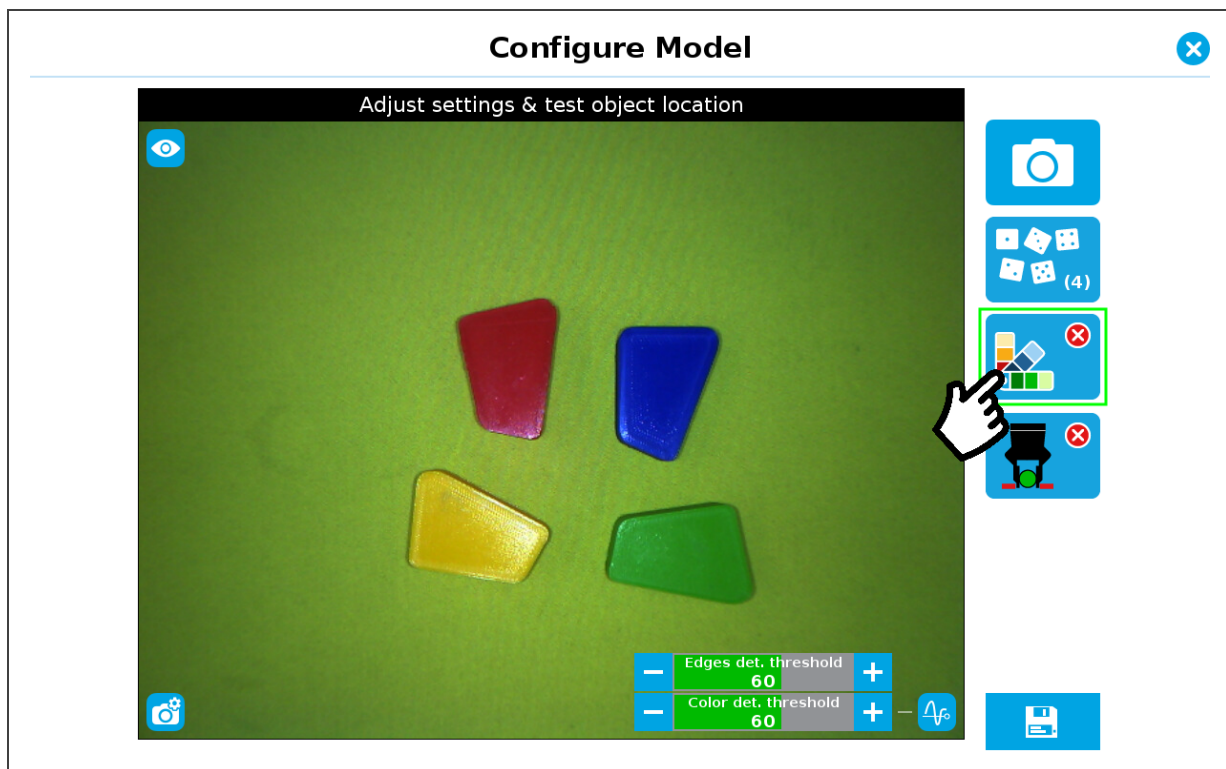

Fig. 4-41: Configure Model with color validation button highlighted.



- Turn on color validation by tapping the red button on the right side of the screen.

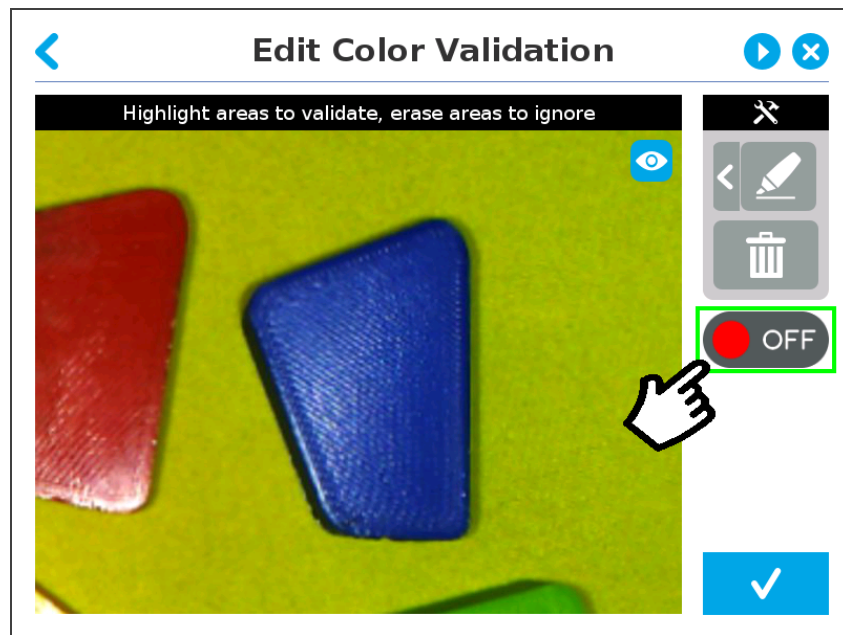

Fig. 4-42: Configure Model Color model with ON/OFF button highlighted

Color sampling tools

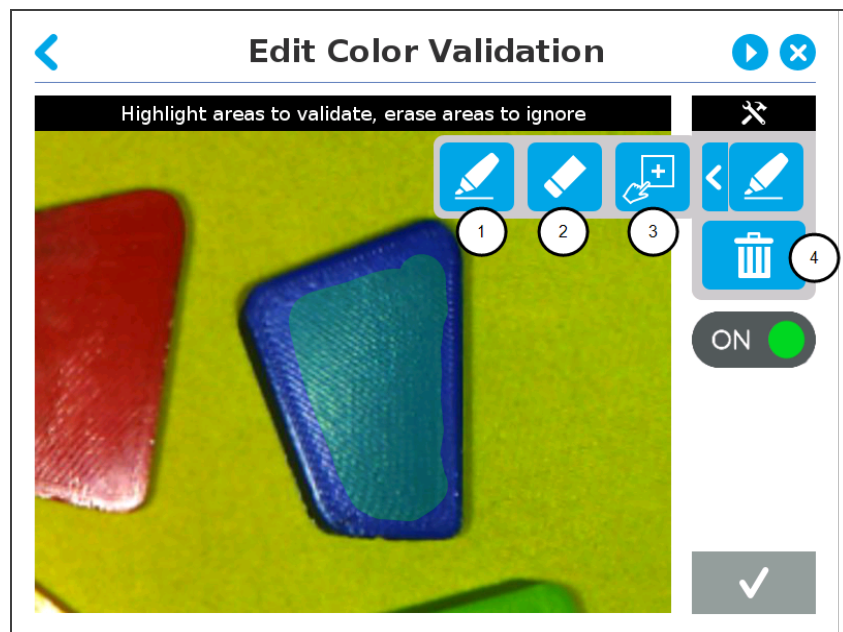

Fig. 4-43: Edit Color Validation with color sampling tools expanded

1. Marker

The marker tool can be used to highlight features and edges to **include and keep** in the color sampling area.

Slide your finger or pointing device on the desired area(s) on the teach pendant. A green layer mask will be applied to the highlighted portion of the model.

2. Eraser

The eraser tool can be used to ignore features and edges in the color sampling area.



Slide your finger or pointing device on the undesired area(s) on the teach pendant.

3. Rectangle+ (add area)

The rectangle+ (add area) tool can be used to quickly highlight desired areas for color sampling.

Tap and drag your finger or pointing device to draw rectangular shapes that will highlight available features.

4. Garbage can

Tapping the garbage can icon will clear the object layer mask, thus deleting the selection area.

Info

The validation routine of the camera is performed in two steps:

1. Contour (edge) validation, with its own detection score
2. Color validation (if applicable), with its own detection score

Tip

Using the color validation helps to avoid false detections in your background.



Fig. 4-44: Examples of Edges Score for (a) a blue part (b) a red part.



Parametric method

1. Tap the color validation button to access the color validation menu.

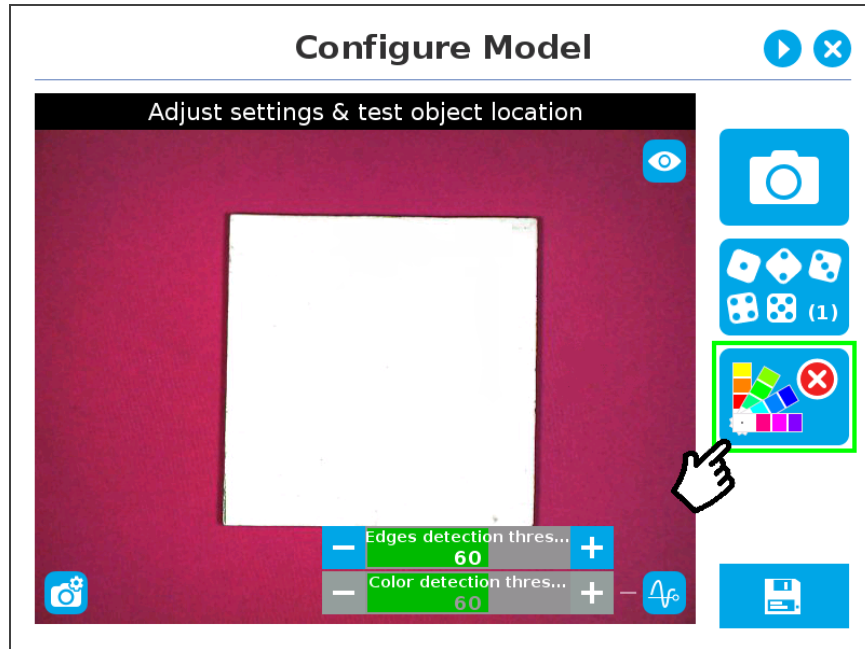

Fig. 4-45: Configure Model Step (Parametric method) with color validation button highlighted.

2. Turn on color validation by tapping the red button on the right side of the screen.

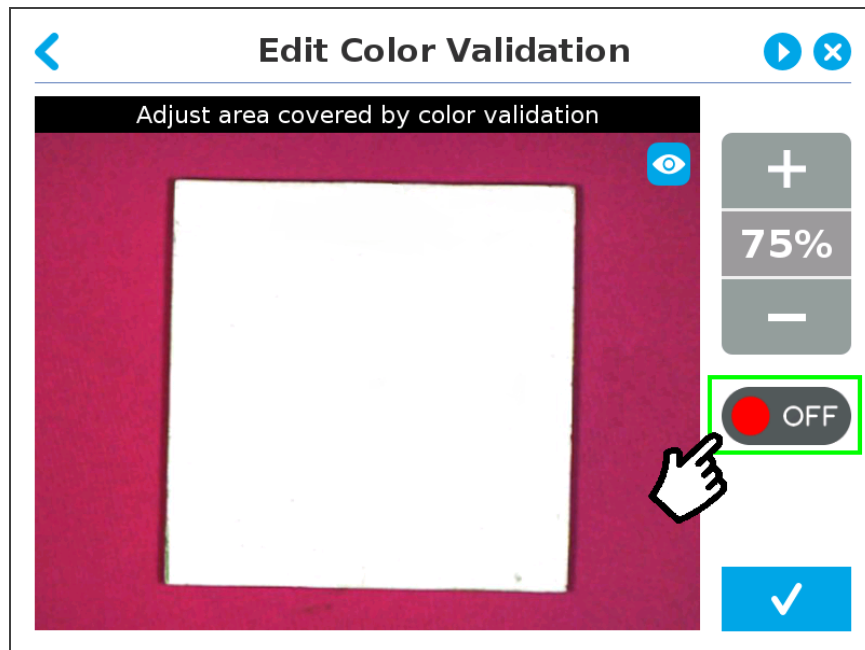

Fig. 4-46: Edit Color Validation menu (Parametric method) with ON/OFF toggle button highlighted.

Color sampling tool

In the parametric method, given the inherent symmetry of the objects located by the system, color validation is supported via an expendable/shrinkable color selection zone, on part with the contour of the object to be located.

Tap the plus icon to expand the color selection zone, and tap the minus button to shrink the selection zone.



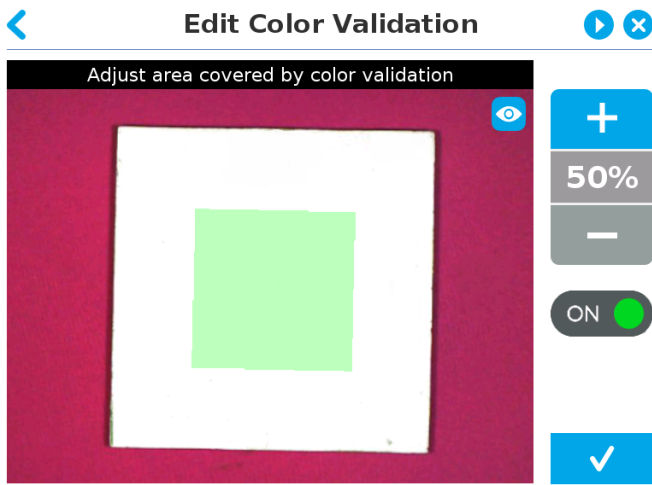

Color selection zone (50% of object size)

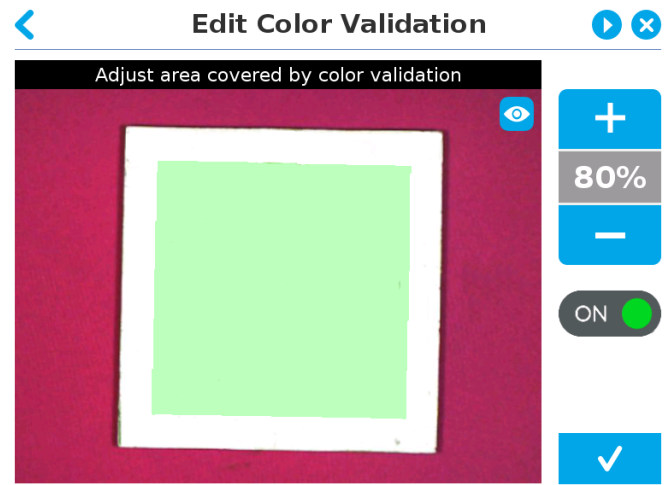

Color selection zone (80% of object size)

Fig. 4-47: Color selection zone (a) 50% of object size (b) 80% of object size

Caution

The size of the color selection zone ranges from 50% of the object size to 150% of the object size.

Detection thresholds and scores

At the Configure model step, the user can tap the Detection threshold button in the lower right corner to expand the detection threshold settings.

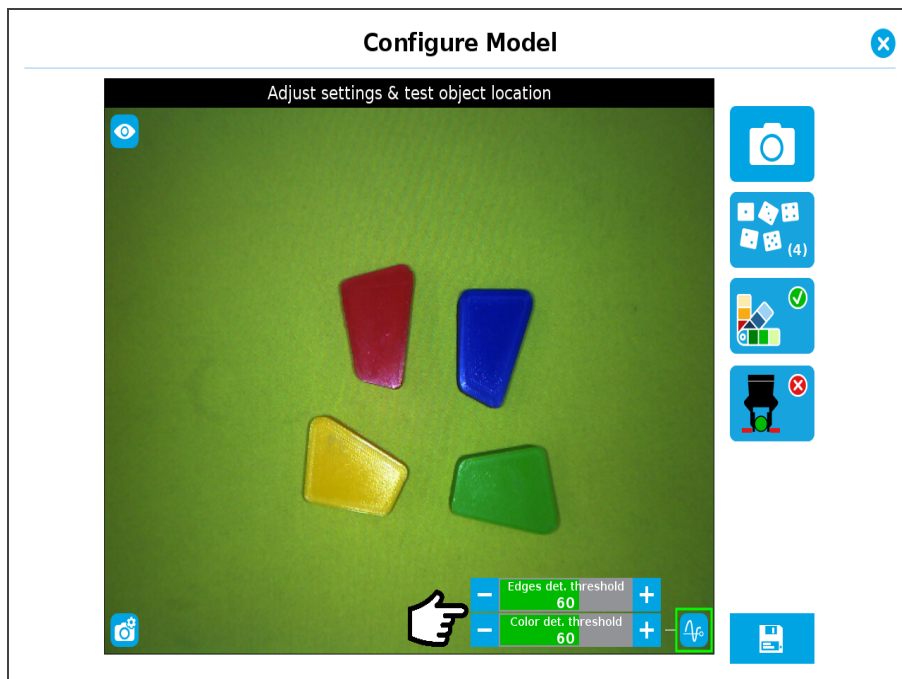

Fig. 4-48: Configure Model Step with detection thresholds highlighted.

After adjusting the detection thresholds, if applicable, the user can test the location of the object(s) in the field of view by tapping the camera icon.



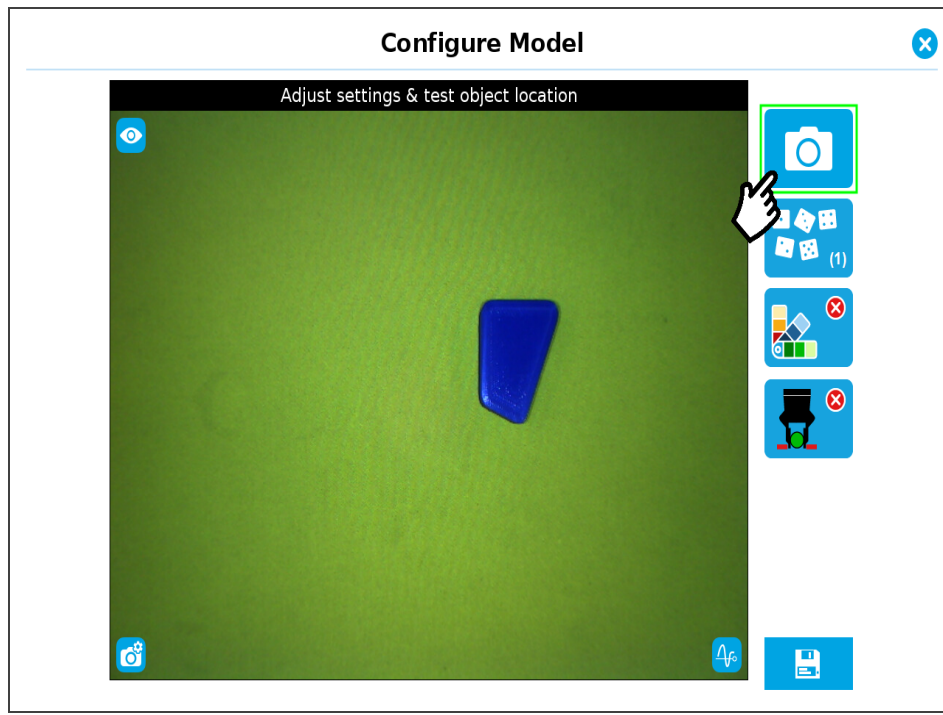

Fig. 4-49: Configure Model Step with camera icon highlighted.

Info

In the context of multiple objects detection, each object detected has its own set of detection score values (%).

Edges detection threshold and score

If the object is found, you will see the object outlined, surrounded by a blue rectangle, with the detection score value (%). If no object is found, an error message will display, reading that the object was not found.

Other objects detected will be surrounded by a white rectangle. Tap the other object(s) to display their own set of detection score values.



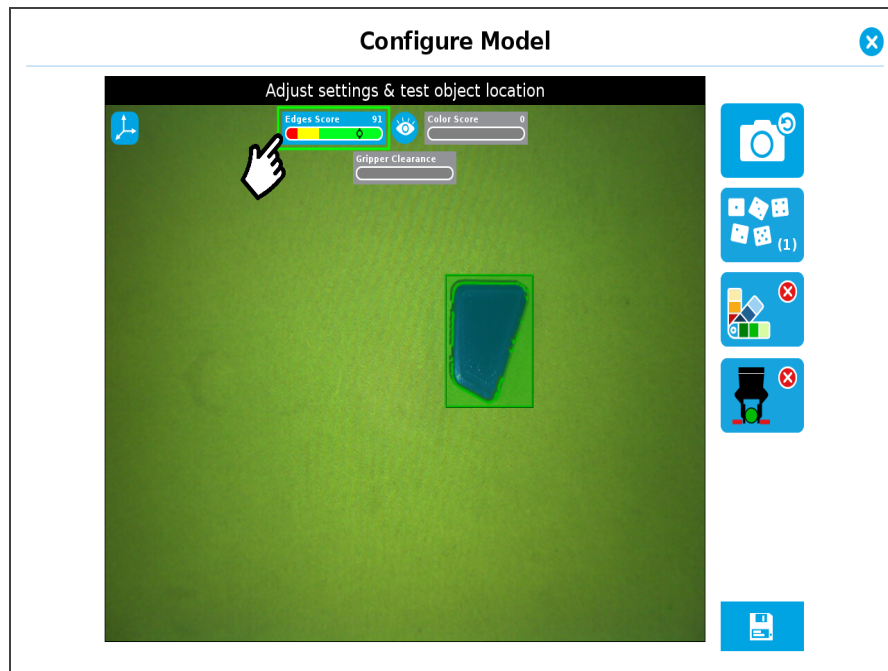

Fig. 4-50: Object found with detection score.

When testing the object(s) locating, object contours and detected features are outlined in green, while features that cannot be located within the field of view of the Wrist Camera are outline in red. Features from the model that cannot be located on the object in the field of view of the camera are outlined in red.

Info

In the context of multiple objects detection, each object detected has its own set of detection score values (%). When performing the localization test, place the whole object over the workplane. Due to the perspective effect, some or all of the object features might not be recognized. If an important feature needs to be found for your application (a hole for example), make sure it is found during all localization tests. Again, green contour should match the object outlines at all times.

Tip

How to prevent false positives: To avoid false detections, remove the object from the workplane, decrease the detection threshold to 0% and try to locate the object. If a false detection occurs on your workplane, you will see an object detected with the detection score. Increase the detection threshold above this score to avoid false detection.

- Try all areas of the workplane on which the object might be found. Adjust the detection threshold properly for the object and for the runtime environment.
- Adjust the detection threshold with the plus (+) and minus (-) buttons.

Tip

Set the detection threshold at the highest value possible so the vision system detects the object on the whole workplane. Tap the **Test locating object** button to test the threshold.

This ensures optimal robustness for object detection everywhere on the workplane. If it is not possible to reach such a success rate, the following should be considered:

- Redefine the Cam Locate node (go through the Teach object wizard again), make sure there are no reflections, or as few as possible.



- Refer to the **Software** section for instructions.

Tip

After completing the object teaching wizard, it is possible to edit the detection threshold. To do so, select the Camera Locate node and go to the Command tab. Click on **Test/Modify** to edit the threshold and/or modify the position of the object.

Color Detection Threshold and Score

Color detection can only happen following a successful edge detection.

Caution

Color validation must be enabled in order to go through the color detection step. Please refer to the **Color Validation** section for more details on enabling color validation.

If the object goes through the 2-step detection successfully, you will see the object(s) outlined, surrounded by a blue rectangle, with the detection score values (%).

Other objects detected will be surrounded by a white rectangle. Tap the other object(s) to display their own set of detection score values.

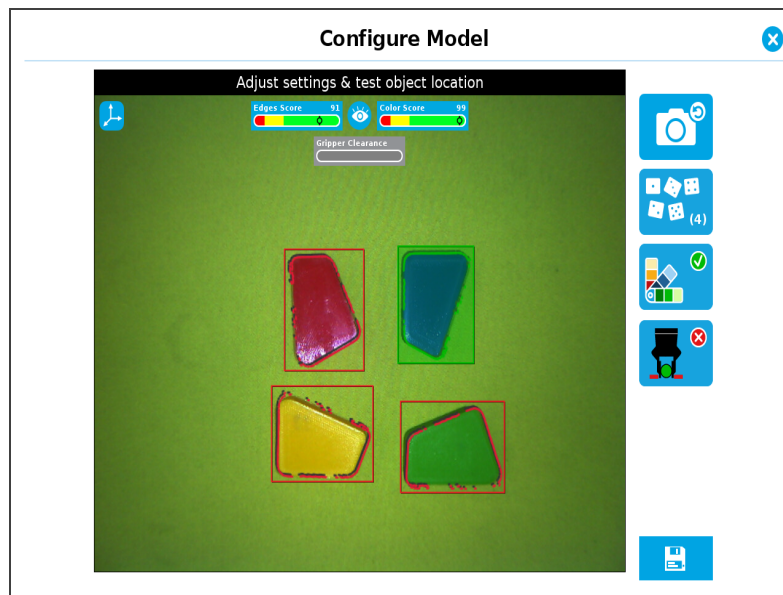

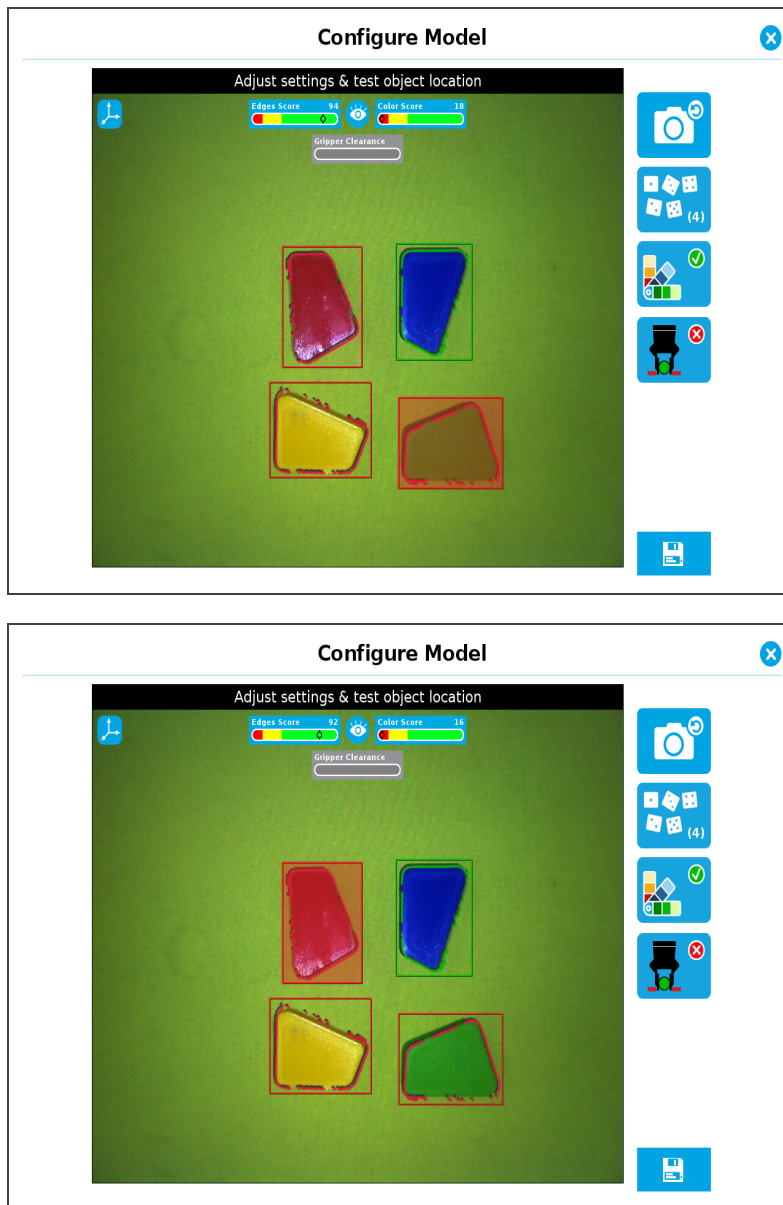

Fig. 4-51: Multiple objects found each with their selection rectangles and detection scores.

Info

In the context of multiple objects detection, each object detected has its own set of detection score values (%).

Gripper Clearance Validation

The Gripper Clearance Validation feature detects parts to avoid unwanted collisions between gripper and parts.

Warning

Gripper Clearance Validation applies to objects of the same model based on identical detection criteria. Other models or objects present in the picture will be disregarded.



Info

To set up Gripper Clearance Validation, you can align objects horizontally. This will optimize conditions for zooming and drawing the area, which in turn will speed up the process.

Set up gripper clearance validation using either the Automatic or the Parametric methods.

Caution

Objects and their corresponding areas should be fully displayed on screen. Otherwise, they cannot be modified.

Validation methods**Automatic and CAD model methods****Info**

The Automatic method is only available when the model is defined with the automatic teaching or CAD model methods.

1. Tap the **Gripper Clearance Validation** button

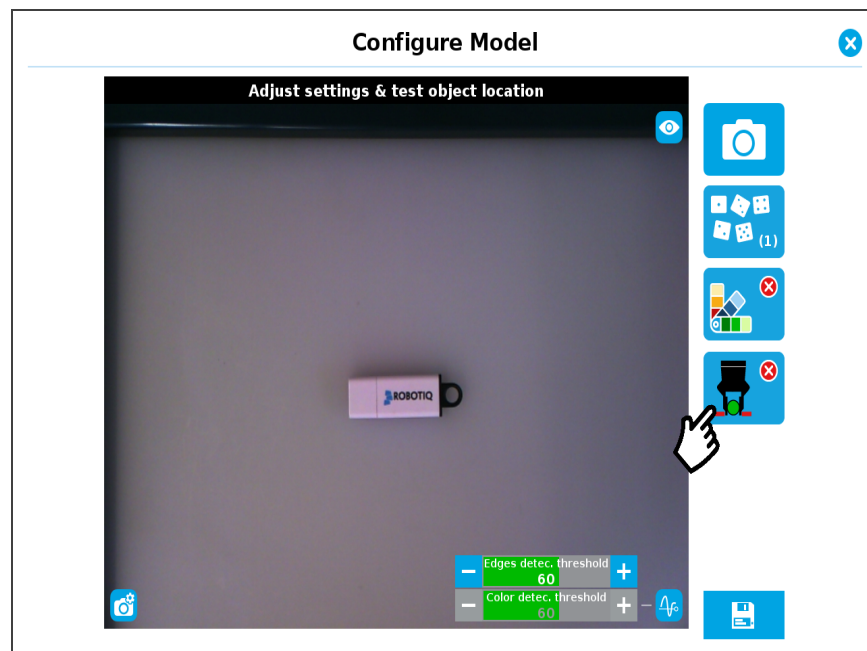

Fig. 4-52: Configure Model with Gripper Clearance Validation button highlighted.



- To toggle Clearance Validation, tap the red button on the right side of the screen.

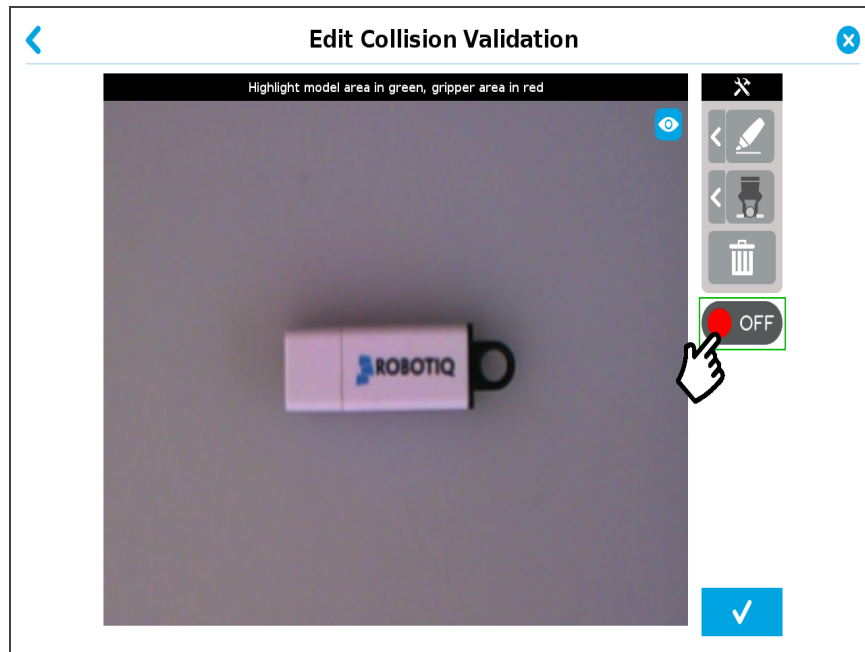
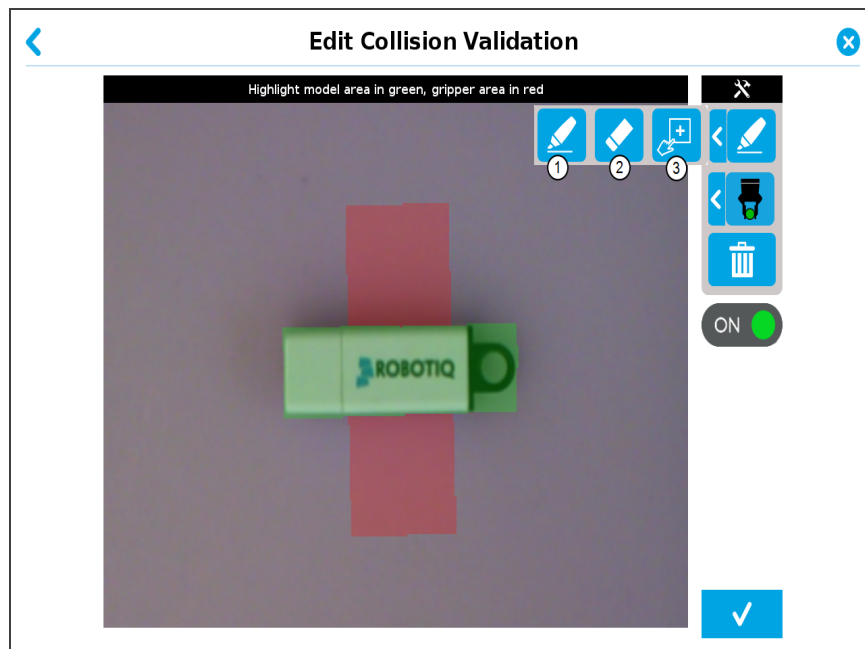

Fig. 4-53: Edit Collision Validation with ON/OFF button highlighted

- Adjust the clearance area with the available tools and tap the checkmark button to confirm the model and collision areas shown on screen. For more details about the gripper clearance sampling tools, please refer to the following section.

Gripper Clearance Sampling Tools



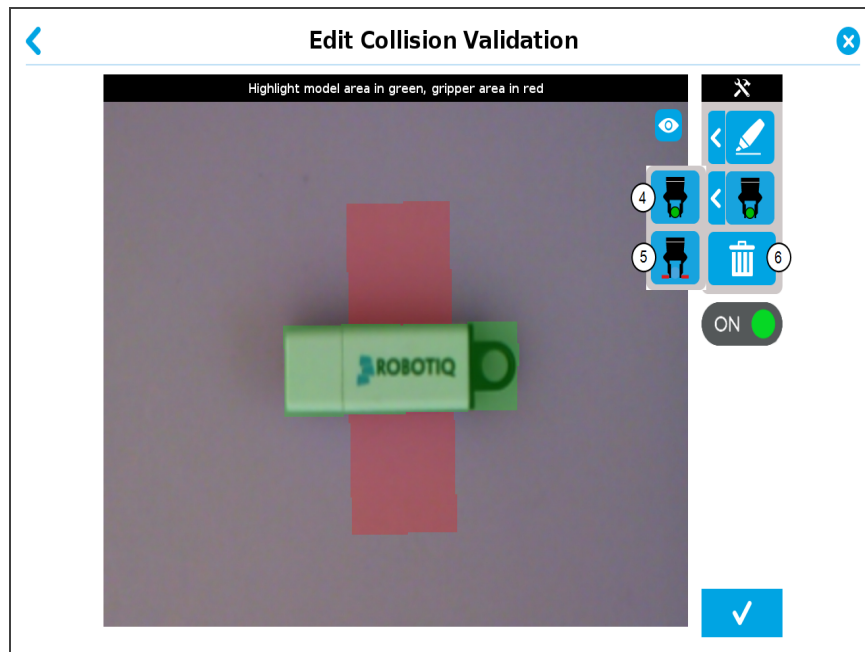

Fig. 4-54: Edit Collision Validation with Gripper Clearance sampling tools expanded.

1. Marker

The Marker tool highlights which features and edges to include in the object detection process. It can also be used to draw the clearance area for collision detection purposes.

Slide your finger or pointing device on the desired area(s) on the teach pendant. Toggle between object/collision detection by selecting either the Model Area (object detection) or Gripper Area (collision detection) buttons.

2. Eraser

The Eraser tool can be used to ignore features, edges and clearance area in selection area.

Slide your finger or pointing device on the undesired area(s) on the teach pendant.

3. Rectangle+ (add area)

The Rectangle+ (add area) tool can be used to quickly highlight desired areas. This tool is extremely useful to define a rectangle for the gripper area.

Tap and drag your finger or pointing device to draw rectangular shapes that will highlight available features.

4. Model area

The Model area button adds or removes features and edges from the collision detection area. The selected area is shown as green on screen.

5. Gripper area

The Gripper area button adds or removes the clearance required for a gripper to pick up an object. The collision detection area is shown as red on screen.

6. Garbage can

Tapping the garbage can icon will clear the object layer masks, thus deleting the selection areas.



Parametric method

Info

The Parametric method is only available when the model is defined with the parametric teaching method.

1. To access the Gripper Clearance Validation menu, tap the **Gripper Clearance Validation** button.

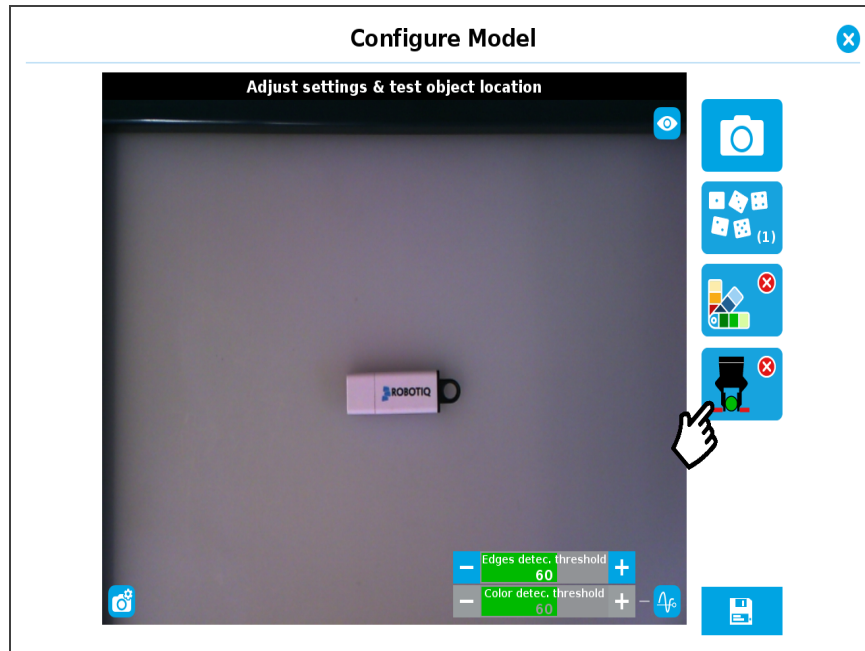

Fig. 4-55: Configure Model screen. The Gripper Clearance Validation button is highlighted.

2. To toggle Clearance Validation, tap the red button on the right side of the screen.

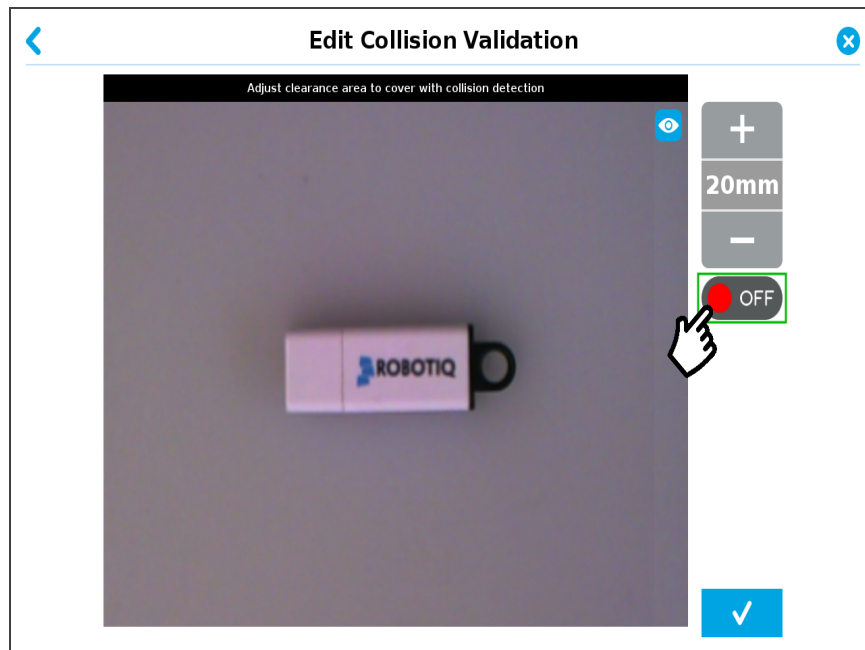

Fig. 4-56: Edit Collision Validation screen. Toggle button is highlighted.



- Set the required clearance around the object using the plus and minus buttons.



Fig. 4-57: Setting up the clearance perimeter.

- Tap the check mark button to confirm the model and collision areas shown on screen.

Clearance verification

While the program is running, it is possible to see if there is enough clearance around the parts seen by the wrist camera. Here are the steps to follow to get this information.

On e-Series robots:

- Tap on the **Installation** tab at the top of the screen
- Select **URCaps** tab in the left pane of the screen



3. Select **Camera** menu
4. Once in Camera menu, tap **Camera** tab.

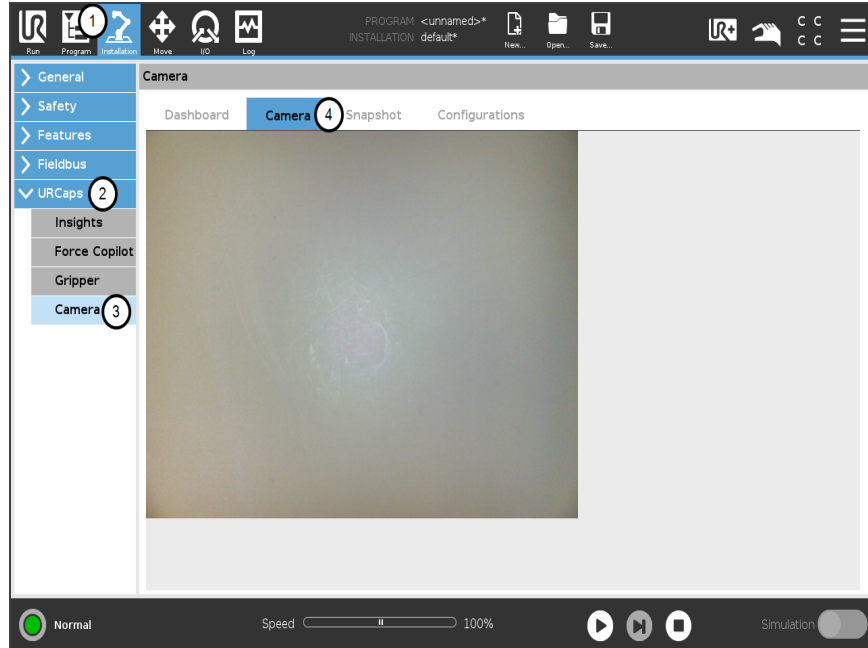

Fig. 4-58: Path to follow to have access to the clearance verification.

On CB-Series robots:

1. Tap on the **Installation** tab at the top of the screen
2. Select **Camera** tab in the left pane of the screen
3. Select **Camera** menu .

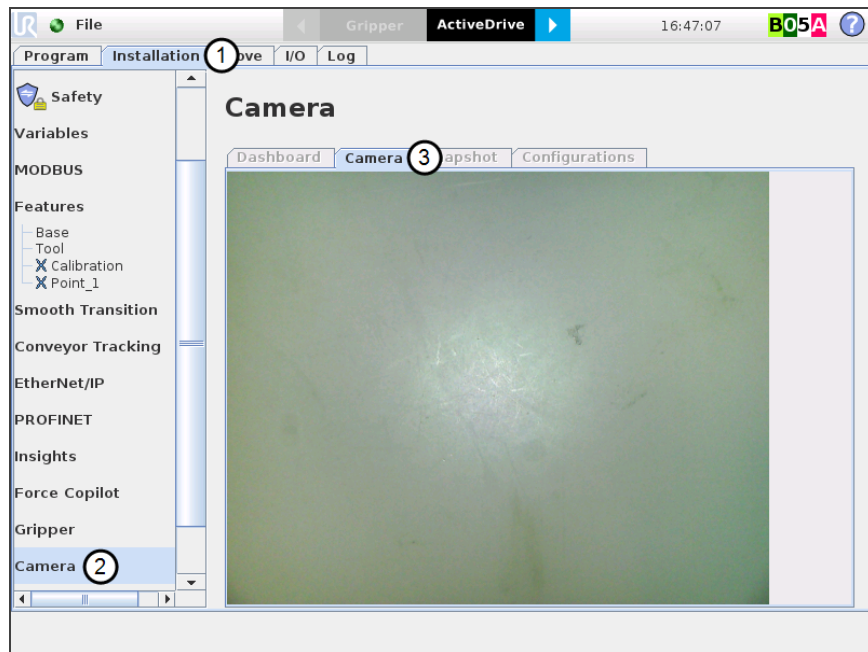

Fig. 4-59: Path to follow to have access to the clearance verification.



The gripper clearance statuses are now available as shown in the figure below.

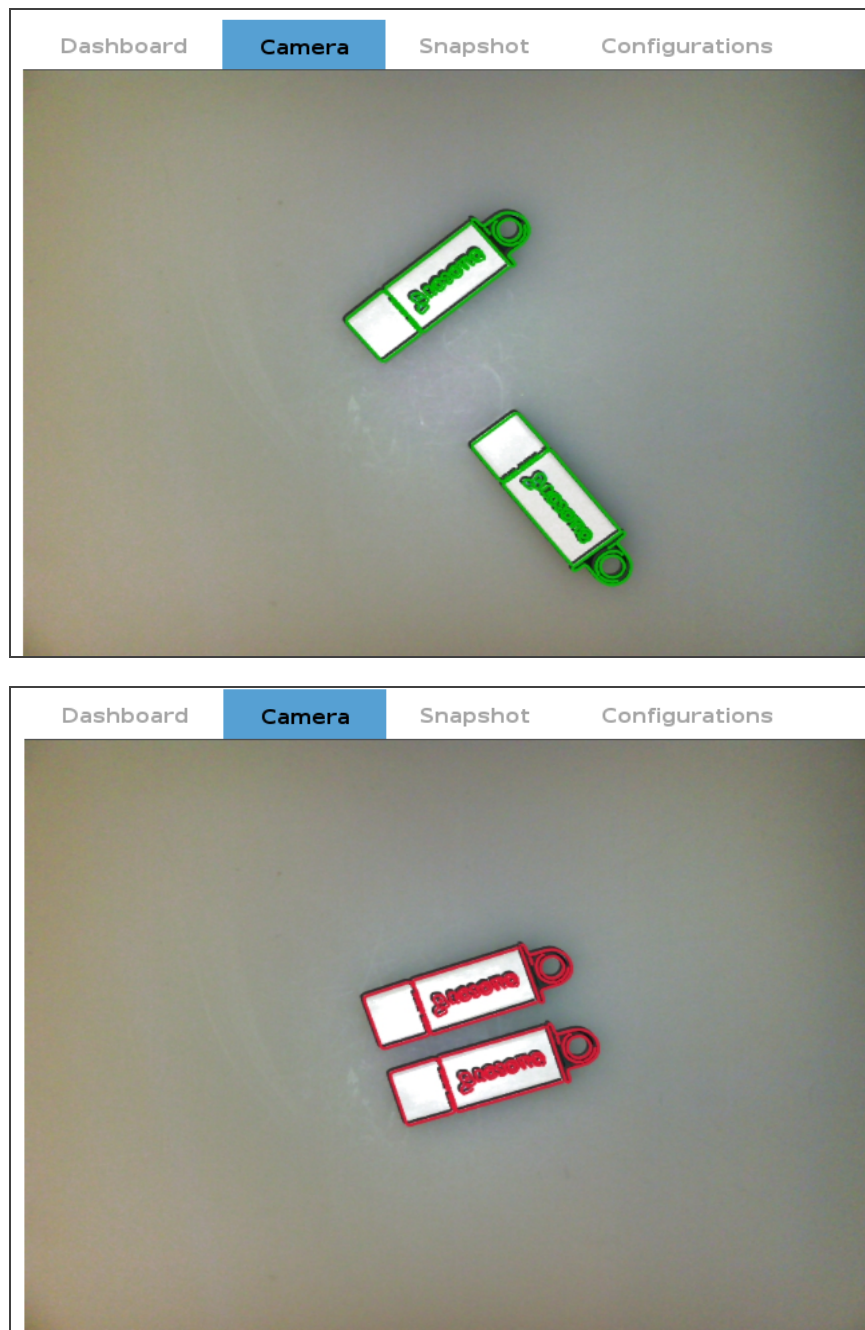

Fig. 4-60: Gripper clearance status while program is running.

Camera settings

Warning

Camera settings can be adjusted at the **Select Model** step of the Automatic teaching method **and/or** at the **Configure Model** step of the Teach object wizard.

Editing the camera settings at the Configure Model step will override the settings selected at the Select Model step of the Automatic teaching method.

Please refer to the **Software** section for more details.



Save location

Once you are done with the test and adjustment, tap the Set reference position button.

Caution

Do not move the object after saving the position; the subsequent relative movements programmed will be relative to that position. Please refer to the **Cam Locate** node section for more details.

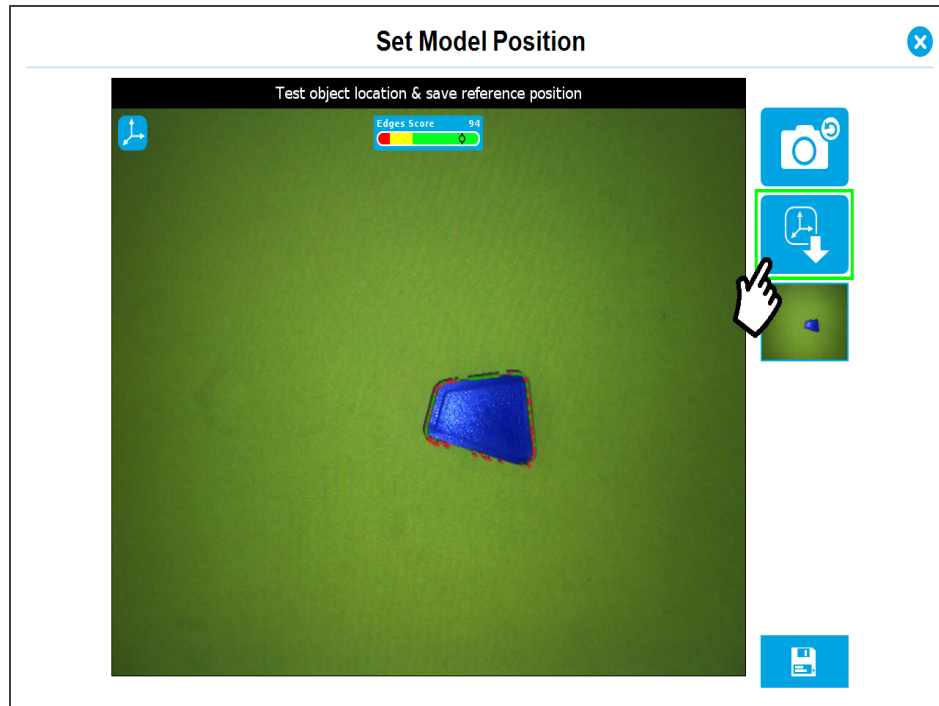

Fig. 4-61: Position defined.

Once the position is saved, tap the **Save & Reset** button in the lower right corner of the teach pendant interface.

When you are done with the teaching process, the Cam Locate node shows a snapshot of your saved object. Modifications can be made. Please refer to the **Edit Cam Locate** section.

4.5. Cam Locate node

The Cam Locate node is used to teach objects. Once an object is taught through the Cam Locate node, you can use it to detect the object on a work plane, and to interact with it. See **Object Teaching** section for a walk through.

Programming

The first thing to do after completing the object teaching is to add a Move node to the Snapshot position. When you exit the object teaching wizard, the robot arm is already in the Snapshot position location. You can simply add a MoveJ command before the Cam Locate node and set it to the location of the robot arm.

Caution

Make sure the robot arm is moved to the Snapshot position before executing the Cam Locate node in the robot program.



The Cam Locate node acts as an "if" statement. If the taught object is detected by the camera, the robot program enters in the Cam Locate node and executes all command lines within it.

After teaching the object within the Cam Locate node, you may continue the programming by using either a linear move (MoveL) with the Snapshot position variable as feature or the `object_location` pose. It is also possible to edit the detection threshold or the saved object position after the Teach Object wizard.

- See **Linear Move with Feature** section to program a robot motion with a linear move (MoveL) with the Snapshot position variable as feature. This allows to perform robot moves relative to the object detected at runtime.
- See **Object_location pose** section to use an `object_location` pose with robot moves. For advanced users.
- See **Edit Cam Locate** section to edit the detection threshold and/or the saved object position.

Cycle Time

The Cam Locate node cycle time is influenced by background complexity, object complexity, and how many objects are on the work plane.

To reduce the Cam Locate cycle time, consider the following at runtime:

- Put fewer objects on the work plane.
- Limit number of object types.
- If your object has many detailed features, you can teach a drawing of it with simplified features or teach only one area of the object.
- Use diffuse lighting, avoiding high light intensity spots on the work plane.

Enabling Fast Cycle Time

If ambient lighting is stable at runtime, you can enable the fast cycle time configuration. Go to the Installation tab > Camera > Configurations, and select Enable fast cycle time.

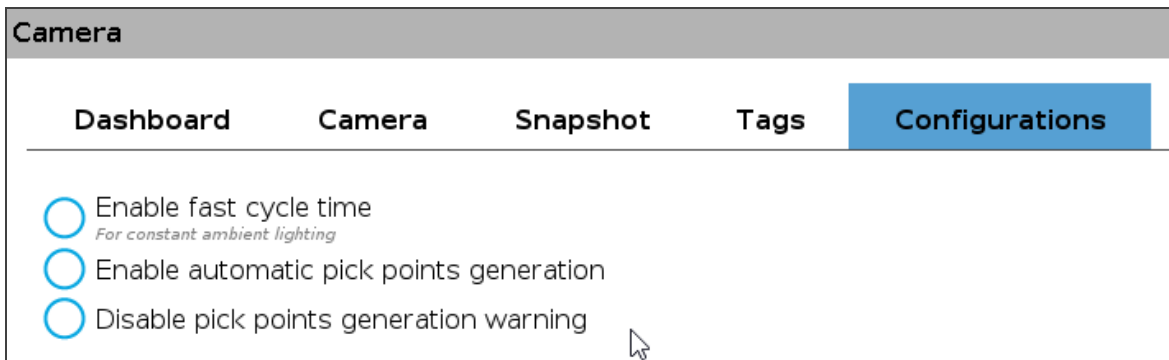

Fig. 4-62: To enable fast cycle time, ambient lighting must be constant.

By enabling the fast cycle time configuration, the camera exposure will be set the first time the program enters a Cam Locate node – at run time. For others Cam Locate nodes, the Vision System retains exposure settings used in the first run. Enabling this option halves cycle time.



Fast cycle time	Behavior of the Vision System	Which to choose
Enabled	Exposure is set once for a first run, and reused in following runs.	Halves cycle time. Ambient lighting must be stable.
Disabled	Exposure must be set at every run.	More robust part detection under variable lighting conditions.

Table 4-2: Fast cycle time configuration.

Fast Cycle Time

Enable the fast cycle time configuration **only if the external ambient lighting is stable.**

4.5.1. Edit Cam Locate

It is possible to edit the detection threshold, camera settings and the object location after the Teach object wizard has been completed. Tap **Cam Locate**> **Command** .

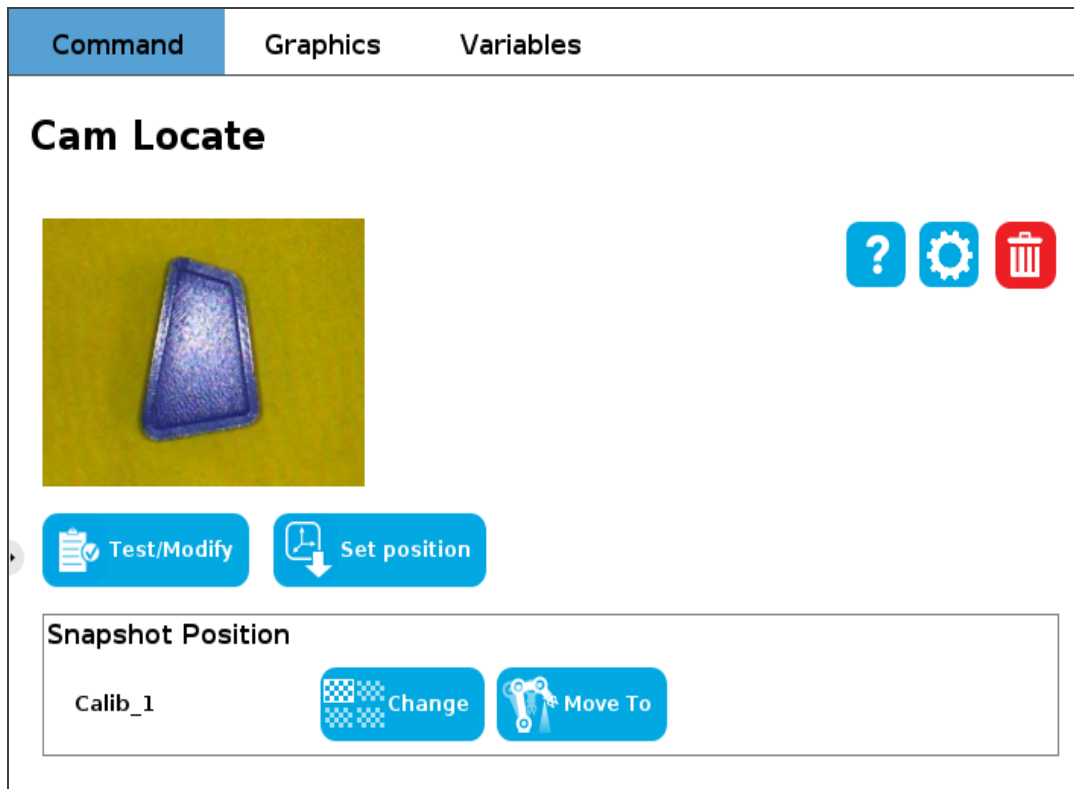

Fig. 4-63: The taught object model can be viewed from the "Command" tab of a Cam Locate node.

- The detection threshold as well as the camera settings and other detection settings can be modified To do so, tap





. The "Configure Model" window is displayed. This does not modify the object position previously saved.

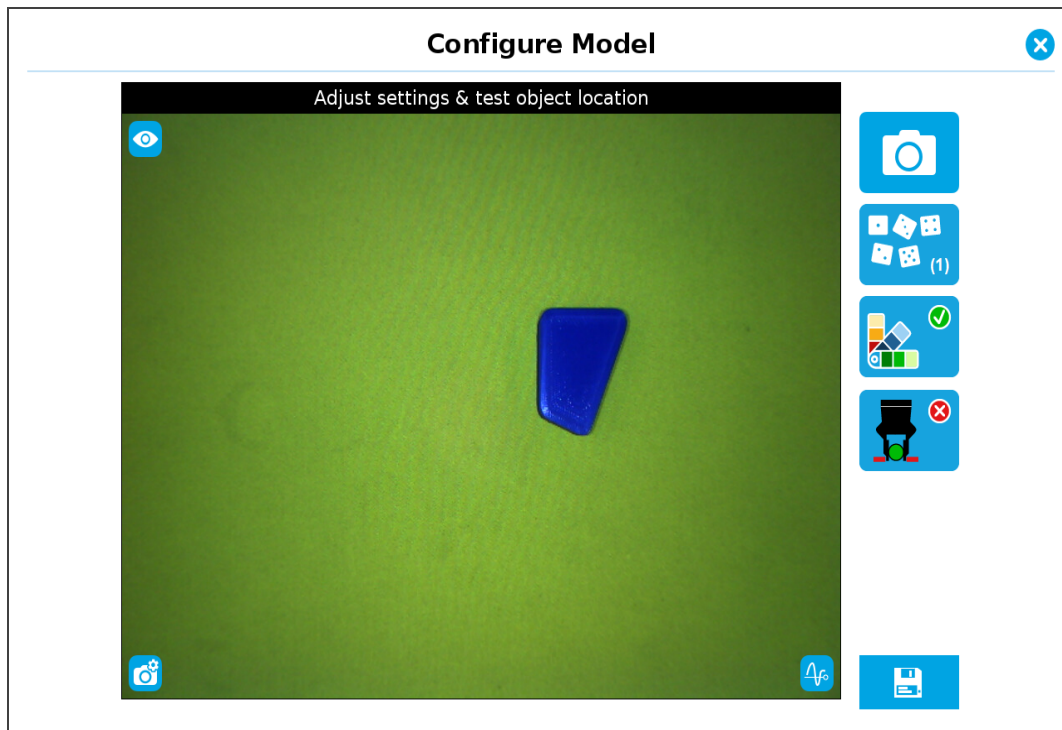



- Object position can be modified. To do so, tap . The "Modify Model Position" window is displayed.

- Move object to its new position. To take the new picture, tap . To confirm this new position, tap .

- A thumbnail of the object appears under .

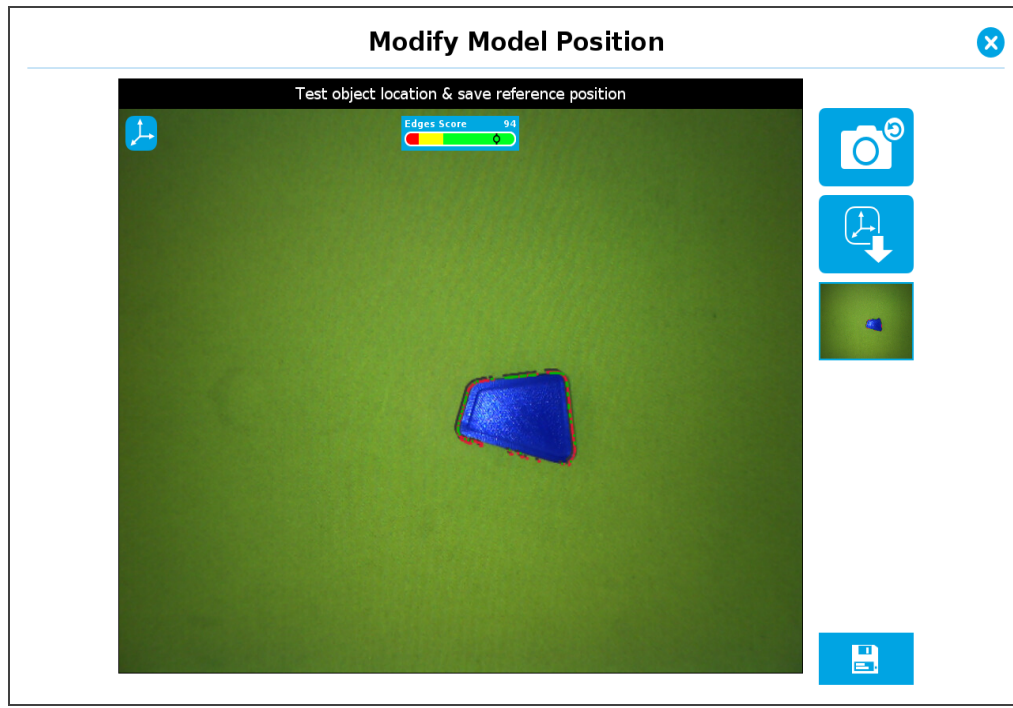

- Tap  to exit the wizard.

- Snapshot position can be changed. To do so, tap . The **Select Calibration** window is displayed. Choose which calibration you want to use for the snapshot position. Then, **Modify Model Position** window is displayed. Tap the Set reference position button to set the model position. Tap  to exit the wizard.

Info

Relative movements in the **Cam Locate** node that are linked to the old snapshot position are updated. They are now linked to the new snapshot position.

- The Wrist Camera can be moved to the selected Snapshot position. To do so, tap .



4.5.2. Auto Pick

The **Auto Pick** functionality is available after teaching an object with the Parametric method, and is used to accelerate adding pick instructions.

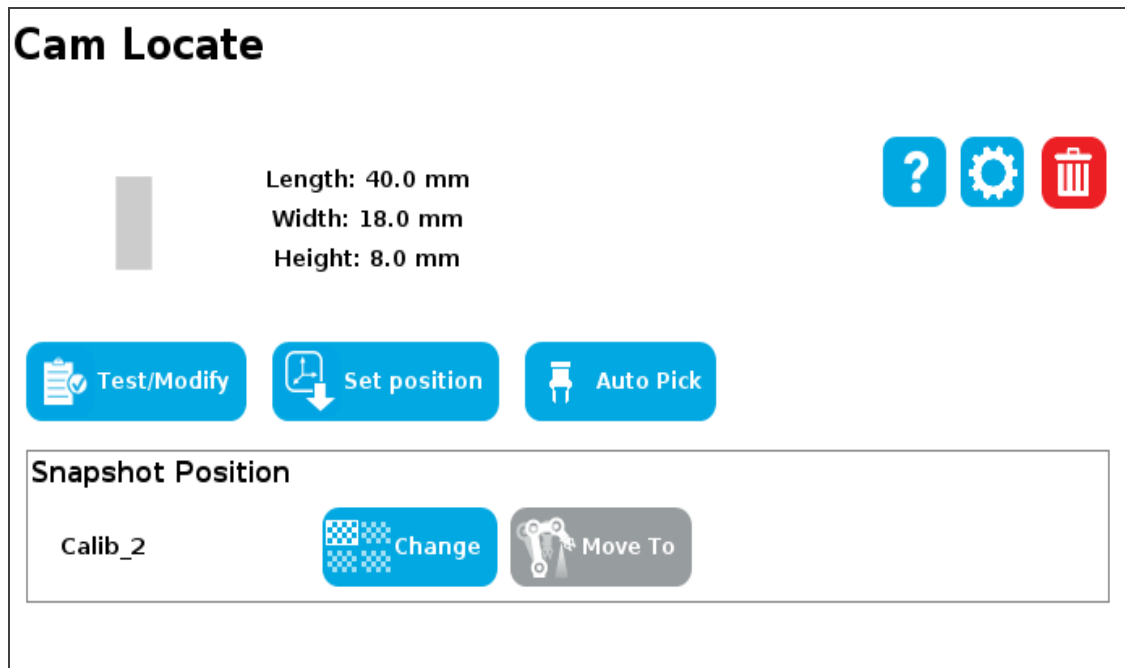
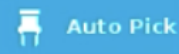

Fig. 4-64: The Auto Pick functionality becomes available after using an object using the **Parametric method**.

When you tap , some nodes are inserted in your robot program under a **MoveL** node, as in the structure shown below:

- MoveL
 - Approach Point
 - Pick Point
 - Comment ("Insert pick action")
 - Retract Point

Basically, Auto Pick inserts a MoveL node based on the values you entered in the Parametric method when teaching the object. The values of "Approach Point" and "Retract Point" are automatically inserted, and based on the values entered when teaching the object. However, these two nodes have independent values.

The approach point added via the Auto Pick button will be located over the object at its exact center. The distance between approach point and object center is calculated based on the TCP value entered in the teach pendant for your hardware setup.

Here is a general view of the Auto Pick functionality, and how it can be used in a robot program.



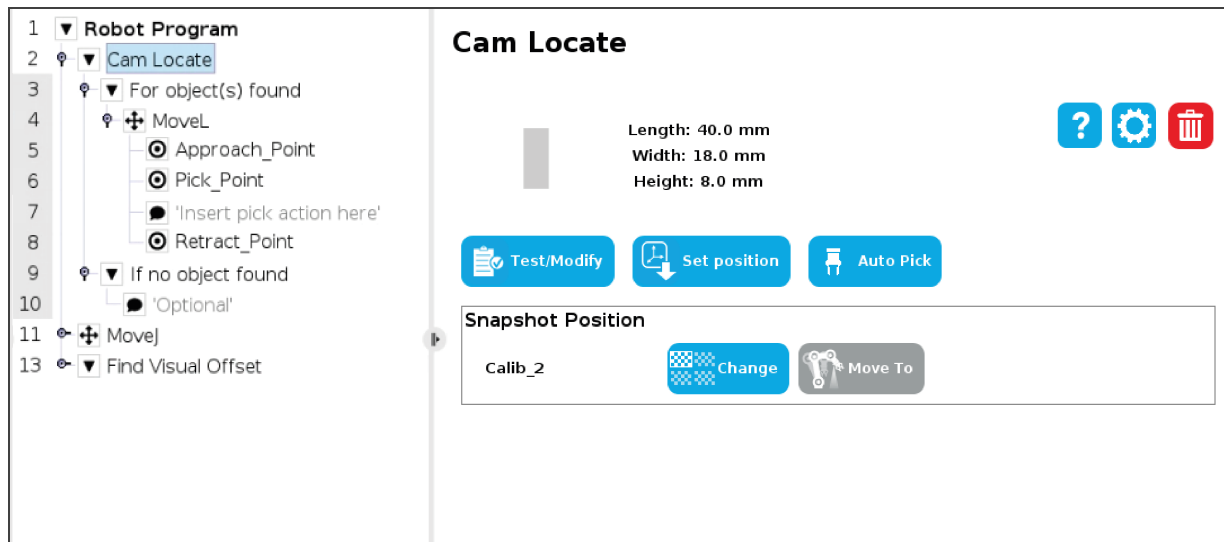
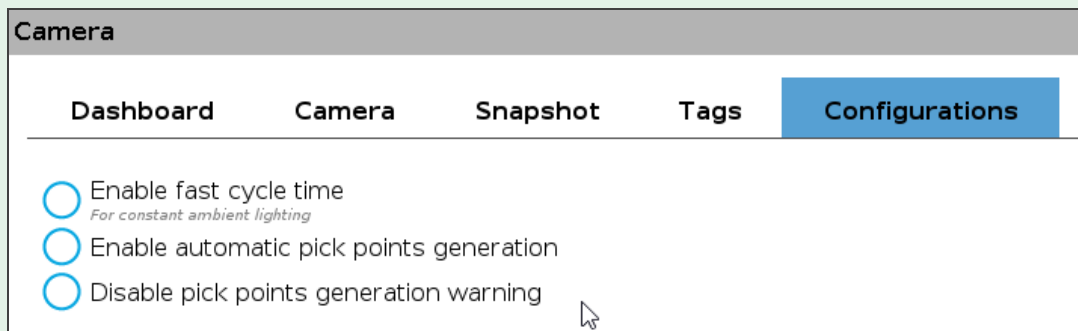

Fig. 4-65: This MoveL node was inserted using the Auto Pick button.

Tip

For a smoother experience using **Auto Pick**, modify teach pendant options under **Installation > URCaps > Camera > Configurations**. Check the following radio buttons:

- "Enable automatic pick points generation"
- "Disable pick points generation warning"



4.5.3. Cam Locate Settings

You can configure a Cam Locate node using the options available by tapping on .

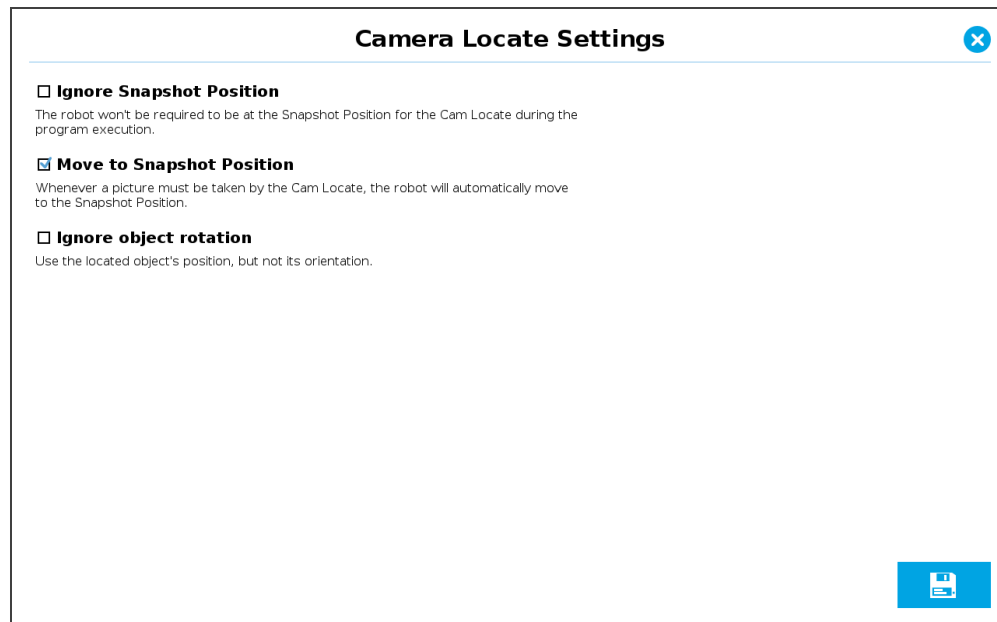

Fig. 4-66: Cam Locate node settings.

Option	Description
Ignore Snapshot Position	The robot won't be required to be at the Snapshot Position for the Cam Locate during the program execution.
Move to Snapshot Position	Whenever a picture must be taken by the Cam Locate, the robot will automatically move to the Snapshot position.
Ignore object rotation	Use the located object's position, but not its orientation.

Table 4-3: These options can be used to reduce cycle time or to improve part detection.

Tips

- Ignore Snapshot Position can reduce cycle time.
- Move to Snapshot Position can improve part detection.
- Ignore object rotation can reduce cycle time for round objects.
- Ignore Snapshot Position and Move to Snapshot Position are mutually exclusive.



4.5.4. Programming a Cam Locate Loop

When you insert a Cam Locate node, it automatically insert If/Else nodes, labelled as "For object(s) found)" and "If no object found" in your robot program.

<pre> 1 ▼ Robot Program 2 ⚙️ ▼ Cam Locate 3 ⚙️ ▼ For object(s) found 4 <input type="checkbox"/> <empty> 5 ⚙️ ▼ If no object found 6 <input type="checkbox"/> 'Optional' </pre>	<h3>Cam Locate Loop</h3> <p><input checked="" type="radio"/> Process all</p> <p>Every node under this one will be executed up to a specified maximum number of objects configured in the Camera Locate.</p> <p><input type="radio"/> Process one at a time</p> <p>Every node under this one will be executed once every time the Cam Locate is executed, unless no object is found.</p> <p>If more than one object is found, the next object is processed when the Cam Locate is executed again, without taking a new picture.</p>
---	--

Fig. 4-67: Cam Locate Loop, "Process all" mode.

If you select the radio button Process one at a time from the "Cam Locate node Loop" window, the node "For object(s) found" is renamed to "For next object".

<pre> 1 ▼ Robot Program 2 ⚙️ ▼ Cam Locate 3 ⚙️ ▼ For next object 4 <input type="checkbox"/> <empty> 5 ⚙️ ▼ If no object found 6 <input type="checkbox"/> 'Optional' </pre>	<h3>Cam Locate Loop</h3> <p><input type="radio"/> Process all</p> <p>Every node under this one will be executed up to a specified maximum number of objects configured in the Camera Locate.</p> <p><input checked="" type="radio"/> Process one at a time</p> <p>Every node under this one will be executed once every time the Cam Locate is executed, unless no object is found.</p> <p>If more than one object is found, the next object is processed when the Cam Locate is executed again, without taking a new picture.</p>
---	--

Fig. 4-68: Cam Locate Loop, "Process one at a time" mode.



Cam Locate Loop

Process all

Every node under this one will be executed up to a specified maximum number of objects configured in the Camera Locate.

Process one at a time

Every node under this one will be executed once every time the Cam Locate is executed, unless no object is found.

If more than one object is found, the next object is processed when the Cam Locate is executed again, without taking a new picture.

Fig. 4-69: The Cam Locate loop can operate on two different modes.

Process all

When this option is selected, the Wrist Camera takes one picture, and finds objects (their number can be changed when teaching the object). Then, the robot program will carry out instructions under "For object(s) found" for all objects that have been found, and finally, the Cam Locate Loop will be exited.

Process one at a time

When this option is selected, the Wrist Camera takes one picture, and finds objects (their number can be changed when teaching the object). Instructions under "For next object" are carried out only once, the robot program exits the loop, and continues. When the Cam Locate node is run once again, the robot program re-enters the loop, locating an object by using the picture that was first taken. When all objects from the picture have been processed, the Cam Locate instruction takes a new picture to find new objects.

4.5.5. Linear Move with Feature

Once the Teach Object wizard is completed, you saved the last position of your object. The object position variable, named after the snapshot position, now contains the reference frame of the object in this saved position. Each time the Camera Locate node localizes an object, it updates that feature variable's frame with the new detected object's position and orientation. That feature is named according to the feature name you chose during the snapshot position definition.

Saved position

The saved object position from the Teach Object wizard or the Test/Save wizard is the position of the object to be used for the relative robot motion programming. Once the position is saved, do not move the object to ensure proper robot motion programming within the Camera Locate node.

You can use that reference feature inside the Camera Locate node within Move commands of the robot. To do so:

- Insert a **Move** node.
- In that node, go to the **Command** tab.
- Select **MoveL**.
- Select the appropriate feature (your Snapshot Position / Feature name).



Every waypoint inserted within that MoveL node will be relative to the feature updated by the Cam Locate.

Move MoveL

Specify how the robot will move between waypoints.

The values below apply to all child waypoints and depend on the selected movement type.

Set TCP: Use active TCP

Tool Speed: 250 mm/s

Feature: Snap_FullBoard_var

Tool Acceleration: 1200 mm/s²

Fig. 4-70: Inserting a Move node with Universal Robots, CB-Series models .

Move MoveL

Specify how the robot will move between waypoints.

The values below apply to all child waypoints and depend on the selected movement type.

Set TCP: Use active TCP

Tool Speed: 250 mm/s

Feature: view_14x11

Tool Acceleration: 1200 mm/s²

Use joint angles

Fig. 4-71: Inserting a Move node with Universal Robots, e-Series models .



4.5.6. Object_location pose

Once a Snapshot position is defined, the work plane used for the calibration gets its own coordinate system, regardless of its orientation. This coordinate system is shown in the figure below.

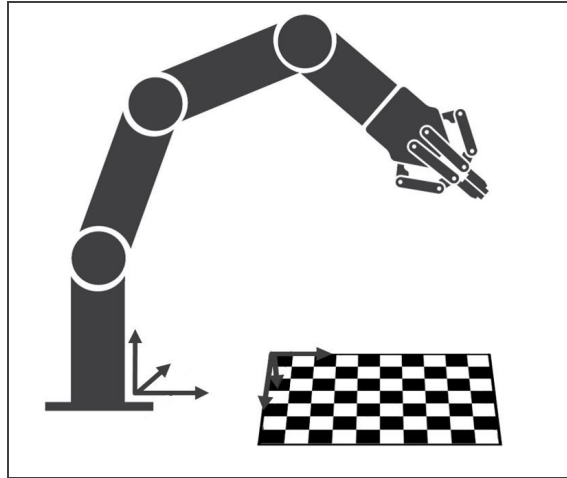

Fig. 4-72: Work plane reference frame.

The Wrist Camera detects an object on the workplane and find its X-Y position, as well as its Z-orientation in the work plane coordinates system (see the figure below). Thus, a detected object is always laid flat (parallel) to the work plane. It is possible to use the `object_location` pose, which is a variable containing the detected object pose [positions X, Y, Z, and rotations Rx, Ry, Rz] in the robot base reference frame. This variable is updated each time the program goes within a Cam Locate node, thus every time an object is detected, regardless of how many Cam Locate nodes are in the program. The `object_location` pose is relative to the robot base frame.

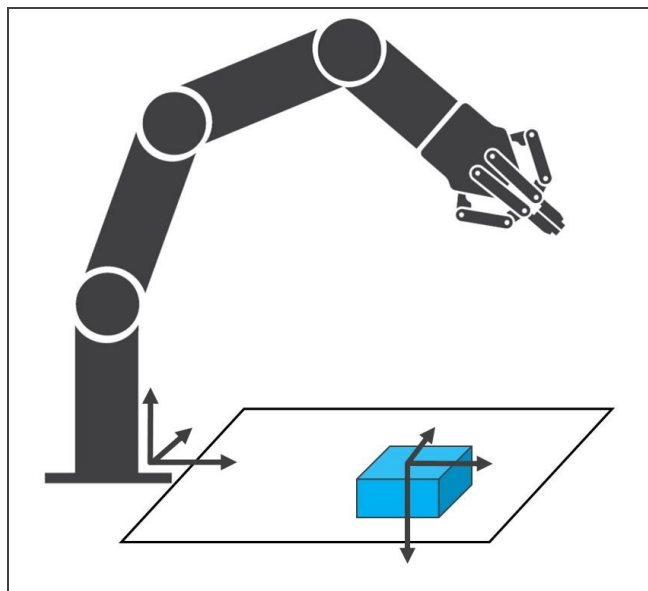

Fig. 4-73: `object_location` pose on the workplane used for the calibration.

- `object_location` is a variable with the pose structure (x, y, z, x rotation, y rotation, z rotation):
- **x**: x position of the object detected, relative to the robot's base reference frame.
- **y**: y position of the object detected, relative to the robot's base reference frame.
- **z**: z position of the object detected, relative to the robot's base reference frame.



- **x rotation:** x rotation from the robot's base frame to the detected object feature reference frame. The object's X axis is parallel to the workplane on which the calibration has been performed.
- **y rotation:** y rotation from the robot's base frame to the detected object feature reference frame. The object's Y axis is parallel to the workplane on which the calibration has been performed.
- **z rotation:** z rotation from the robot's base frame to the detected object feature reference frame. The object's Z axis is normal to the workplane on which the calibration has been performed, points downwards from it, into the workplane.

Object_location pose and TCP

If you move the robot's TCP to the object_location pose, the TCP will go and point the object on the workplane. The height value of the object on the workplane should not be taken into account - the TCP might be directly on the object when moving it to the object_location pose.

Program Example

The program examples below show how to use the object_location pose variable. The first one simply moves the robot so that the TCP goes directly on the detected object. Make sure the TCP is set properly to avoid collisions.

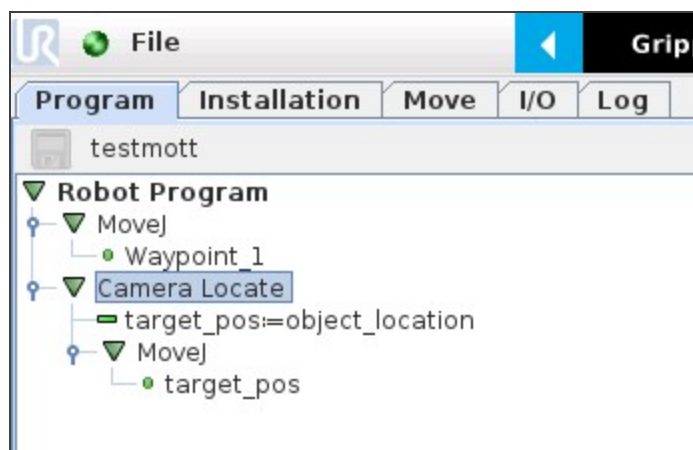

Fig. 4-74: Program example - place the TCP on the detected object. CB-Series robot program is illustrated.

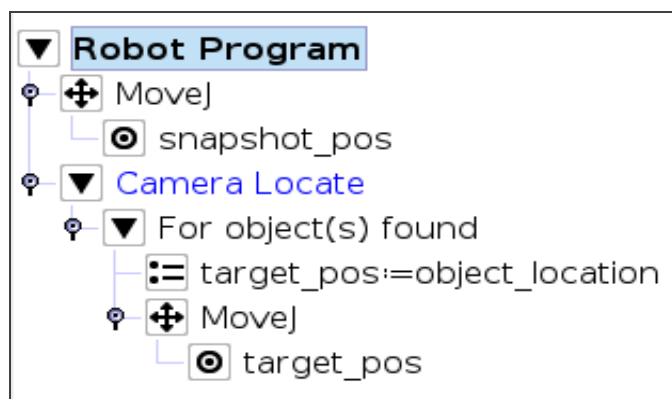

Fig. 4-75: Program example - place the TCP on the detected object. e-Series robot program is illustrated.

The second example moves the robot so that the TCP goes 20 cm above the detected object. This is in the case of an horizontal plane.



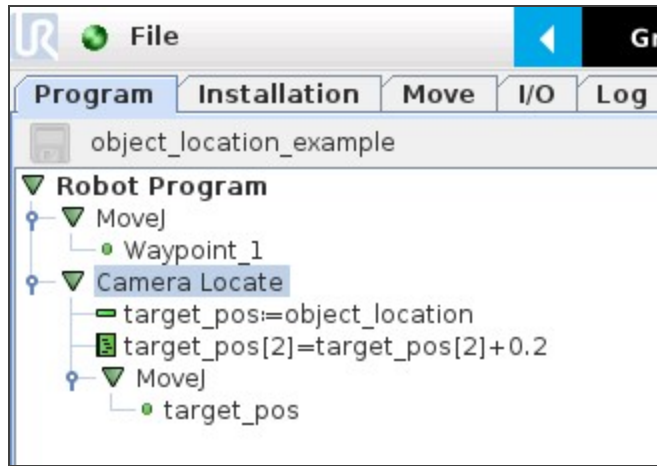

Fig. 4-76: Program example – Place the TCP 20 cm above the detected object, in case of an horizontal plane. CB-Series robot program is illustrated.

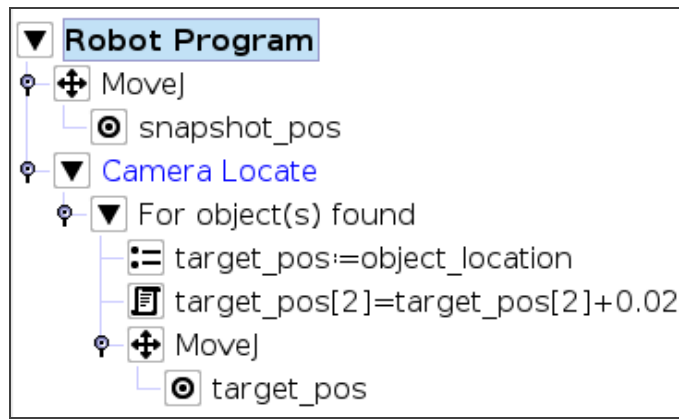

Fig. 4-77: Program example – Place the TCP 20 cm above the detected object, in case of an horizontal plane. e-Series robot program is illustrated.

Info

A statement, called `If no object found` is also present to determine the action to do when `Cam Locate` does not find any object.

	<h3>Comment</h3> <p>Please enter comment:</p> <input type="text" value="Optional"/>
--	---



4.5.7. Using a Variable Snapshot Position

During a robot program, the robot must be at the snapshot position before entering the Cam Locate node. If it is not in the right position, a pop-up will appear, preventing the camera from taking a snapshot from the wrong position. This is to ensure good precision since the workplane has been previously calibrated for this snapshot position.

In some cases, it is helpful to move the robot to a variable position to enter a Camera Locate node. For instance, it can also be used to teach only one snapshot position and object to manage parts in stacked trays. In order to do so, allow the robot to be in a different position than the original snapshot position by entering the script command:

```
ignore_snapshot_position = True
```

You also need to edit the `snapshot_position_offset` pose variable. This variable contains the pose offset between the original saved Snapshot position and the one used in the program .

Info

Please note that the arguments of the `snapshot_position_offset` parameter are expressed in the robot base reference frame.

The example shows a program using a Cam Locate node to manage parts in stacked trays.

- The script command in the BeforeStart section allows the camera not to be in the exact snapshot position when entering a Cam Locate node.
- The pose at which the robot enters the Cam Locate node is calculated knowing how many trays are stacked.
- The `snapshot_position_offset` is calculated accordingly for the Wrist Camera to consider the pose offset from the original Snapshot position.

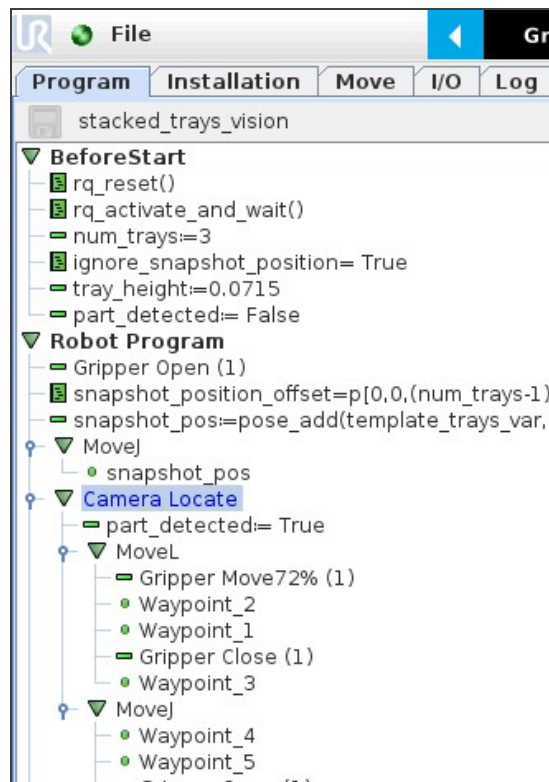

Fig. 4-78: Program example, using Universal Robots CB-Series models.



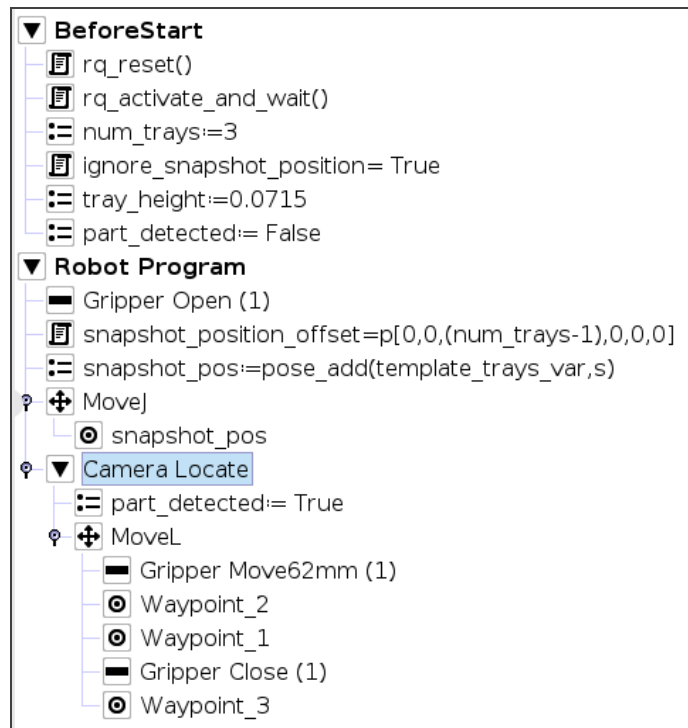

Fig. 4-79: Program example, using Universal Robotse-Series models.

ignore_snapshot_position = True

When using this method, make sure the workplane has the same orientation and distance regarding the position of the camera before a Cam Locate node. Using a variable and relative Snapshot position may decrease the precision, as the workplane can be slightly different depending on where the calibration has been performed. Be aware of this when programming a Cam Locate node relative to another one.



4.6. Scan Code node

4.6.1. Supported Types of Codes

The Scan Code node is used to read various types of barcodes and 2D codes (QR, Datamatrix, PDF417).

Code Image	Type
	Datamatrix
	QR
	PDF-417
	Code 93
	EAN-8
 0 123456 789012	EAN-13
 1234567890	ITF-14
 0 123456 5	UPC-E
 1 23456 78901 2	UPC-A
	Code 39
	Code 128



4.6.2. Guidelines on Reading Codes

Tips

Follow these recommendations to improve codes readings.

- Code must be entirely visible in the field of view of the Wrist Camera.
- However, code should not fill the field of view entirely. Some whitespace must be left around its edges. Moving the Wrist Camera away from the code should increase its field of view and provide an adequate amount of whitespace.
- Background must contrast the code to read.

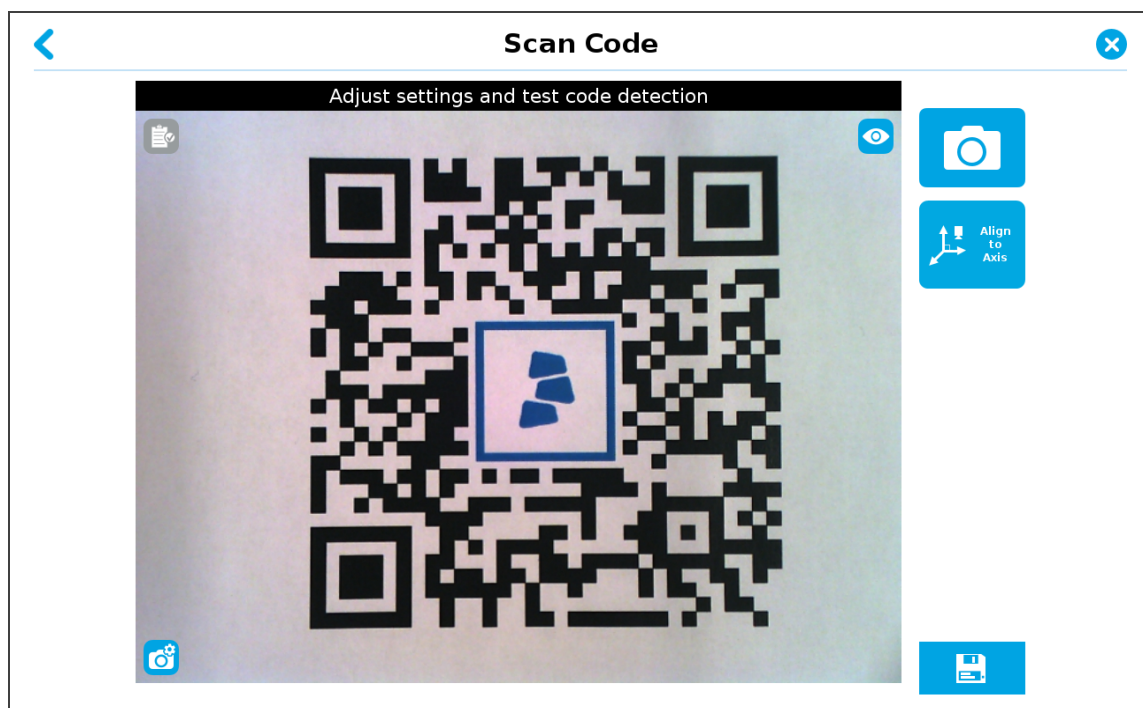

Fig. 4-80: This code cannot be read because there is not enough whitespace around its edges.



4.7. Using the Scan code Node

Scan Code





1. Tap Program > URCaps > Scan Code.







2. Tap

Select Code Type

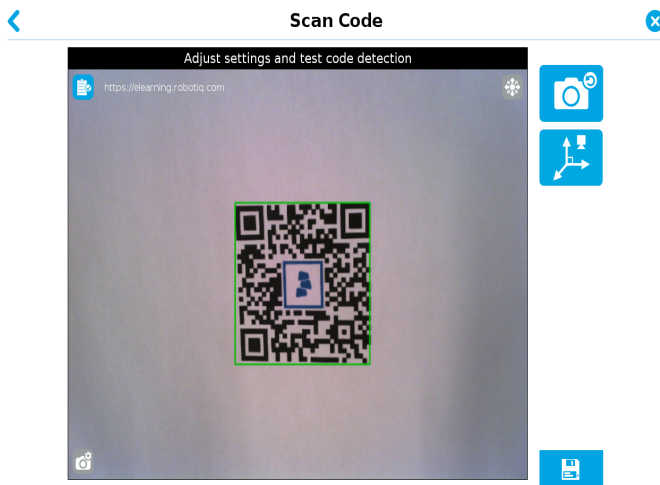

3. The window "Select Code Type" is displayed. Tap the applicable code type. To navigate pages for additional code types, use  and .



4. Put code on workplane, then tap , or  if you are not satisfied with the result. Save your code by tapping .

Tip

You can tap  to display the string that was read from the code.

This is useful when testing if your codes are read properly under your specific operating conditions.



Scan Code



Code Type : QR

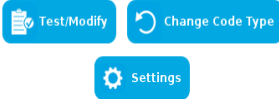

Variable **rq_is_code_found**
True if a code was found, False otherwise.

Variable **rq_code_string**
Contains the data of the code found.

5. To save your readings, tap . The "Scan Code Settings" window is displayed.

Scan Code Settings

Enable TCP/IP communication of code string

Server Address:
TCP port:



Enable saving code string to file

Save to directory:

6. To save collected strings to a file, check either box, or both. If you choose to save your data locally, you can use a USB stick to do so. The data will be stored in a **.CSV** file.

You can also use the string value during a program. Its value is stored in variable **rq_code_string**, found in the **Variables** tab.

4.7.1. Strings Data Stored in CSV files

	A	B	C	D	E	F
1	TimeStamp, CodeType, CodeData					
2	2019-11-01T15:53:22.892892,	QR	CODE,	https://robotiq.com/		
3	2019-11-01T15:53:29.949949,	QR	CODE,	https://robotiq.com/		
4	2019-11-01T15:53:37.03030,	QR	CODE,	https://robotiq.com/		
5	2019-11-01T15:53:44.07474,	QR	CODE,	https://robotiq.com/		
6	2019-11-01T15:53:51.09999,	QR	CODE,	https://robotiq.com/		
7	2019-11-01T15:53:58.226226,	QR	CODE,	https://robotiq.com/		
8	2019-11-01T15:54:05.229229,	QR	CODE,	https://robotiq.com/		
9						
10						
11						
12						

Fig. 4-81: Each line represents one code that was read.



Data is presented in the following order: TimeStamp, CodeType, CodeData. Data elements are separated by commas.

Data Element	Description
TimeStamp	Records the year, month, date, hour, minutes, seconds, and seconds decimals at which the code was read.
CodeType	Records which type of code was read.
CodeData	Records a string read from a code.

4.8. Find and Apply Visual Offset nodes and Defining tags

The Wrist Camera Visual Offset capabilities are based on two nodes: Find Visual Offset and Apply Visual Offset. By attaching a Robotiq tag to a fixture (a tray, for instance), you can teach robot moves which are relative to this tag position. In other words, you can first teach the tag position, then teach moves, and even if your tray was moved, your robot program will compensate its move commands, first by finding out by how much the tray was displaced (using the node Find Visual Offset). This value is stored, then applied to moves under the node Apply Visual Offset subprogram.

4.8.1. Tag creation and definition

1. Attach a tag to any surface. It is a reference feature for your robot program. The back of the tag has adhesive bands to help attach it.

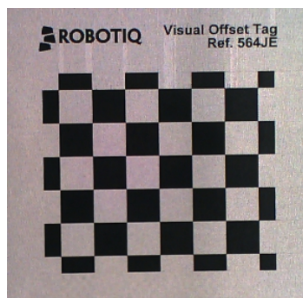

2. Move your robot to a position from which the Wrist Camera can fully see the tag.
3. If you have not calibrated the Wrist Camera, please do so now.
4. Go to **Installation > URCaps > Camera > Tags**.
5. Click on  to create a Tag.



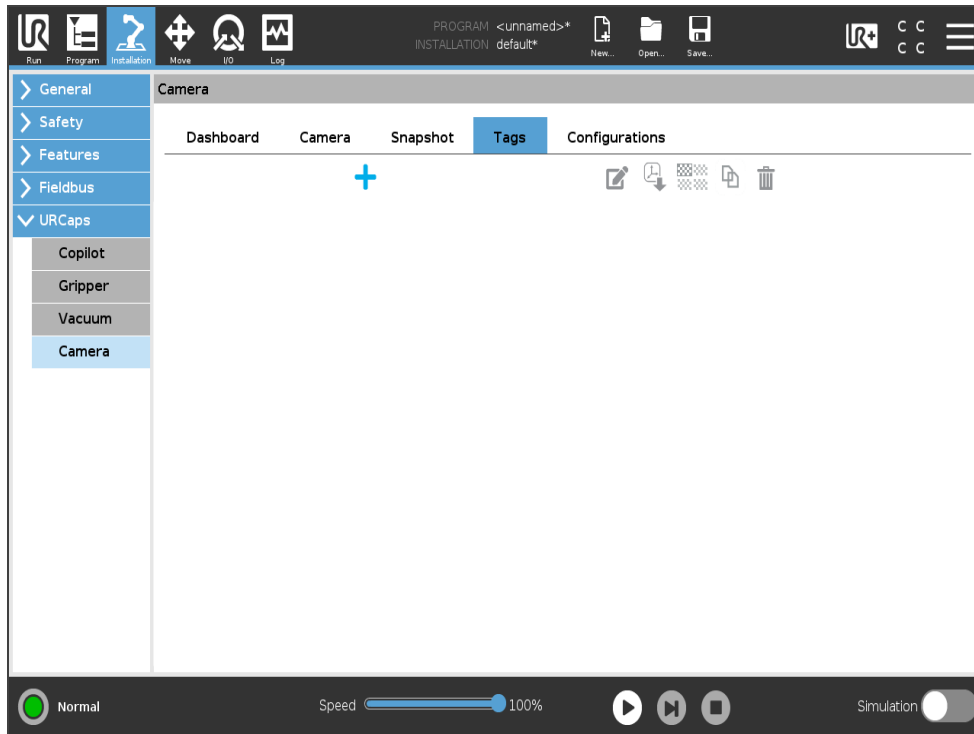

6. Select the Camera Calibration to use to detect the tag.

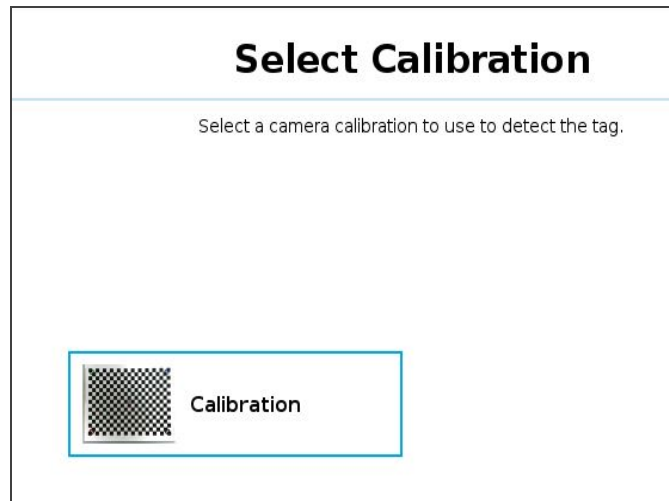



7. Define Far Camera position:

A far camera position have to be defined considering all the possible tag locations.

- The recommended **Distance** and **Angle** are:
 - i. **Far position**: 200 to 350 mm
 - ii. **Angle (Far or close)**: 50 to 70 ° and 110 to 130 °.



Tip

- To help you reach the recommended distance and angle, use the joystick and the  button. You can also use the  button to allow to center the tag in the middle of the picture while keeping the same orientation.

- To display the real time angle and distance , click on the  button.

Tip

- On the top right, click on the  button to display the **Translation** and the **Spherical** joysticks so you can move the robot in real time.
- The **Spherical** joystick is available once a tag is detected. It allows to move spherically around the tag.

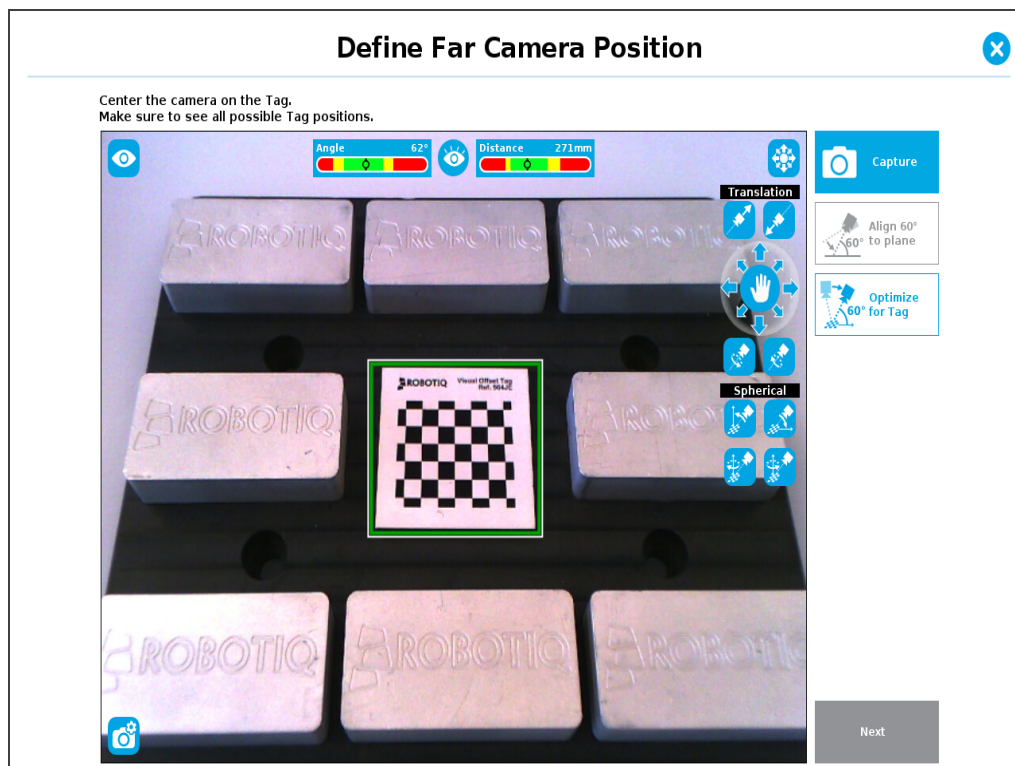

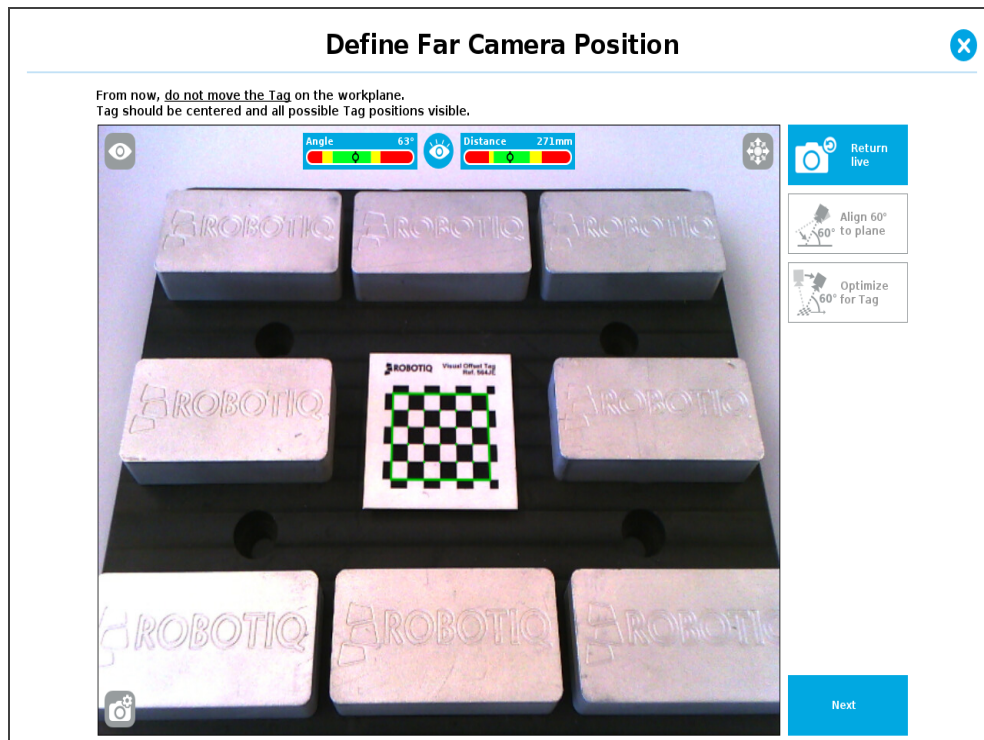

Fig. 4-82: Far Camera position definition

- By clicking on  button, it will display the screen below. Yo can go back by clicking on **Return live** or click on **Next** to pass the definition of the close relative camera position.





8. Define Close relative Camera position:

Use the same method as previously described for the Far Camera position above.

- The recommended **Distance** and **Angle** are:
 - i. Close position: 100 to 200 mm
 - ii. Angle (Far or close): 50 to 70 ° and 110 to 130 °.

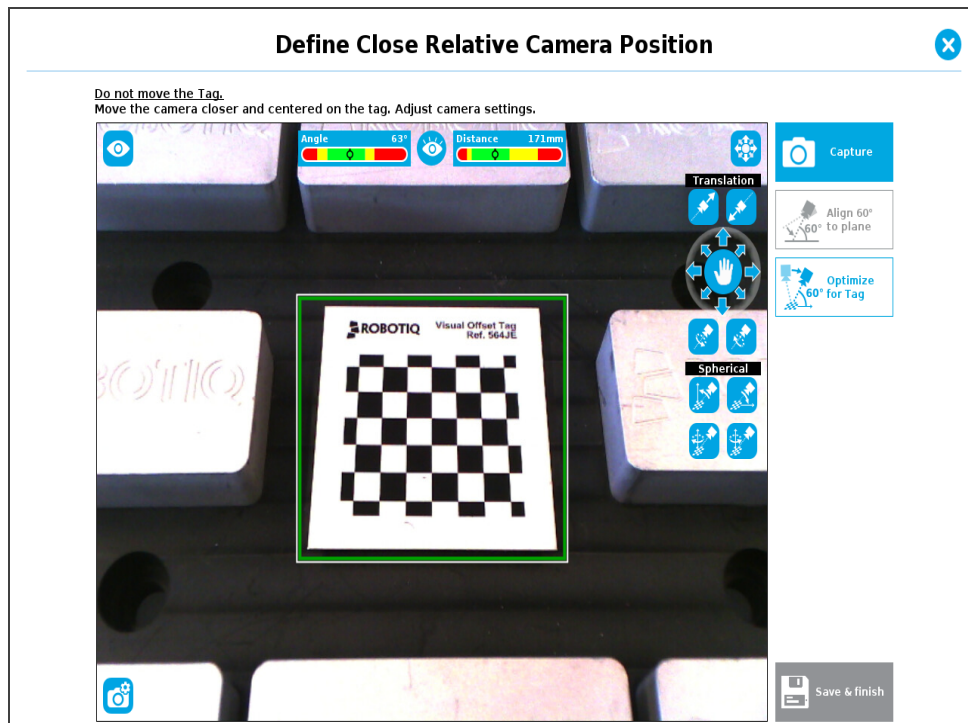

- Once your tag is located and captured, click on **Save & Finish** to complete the Tag Creation.

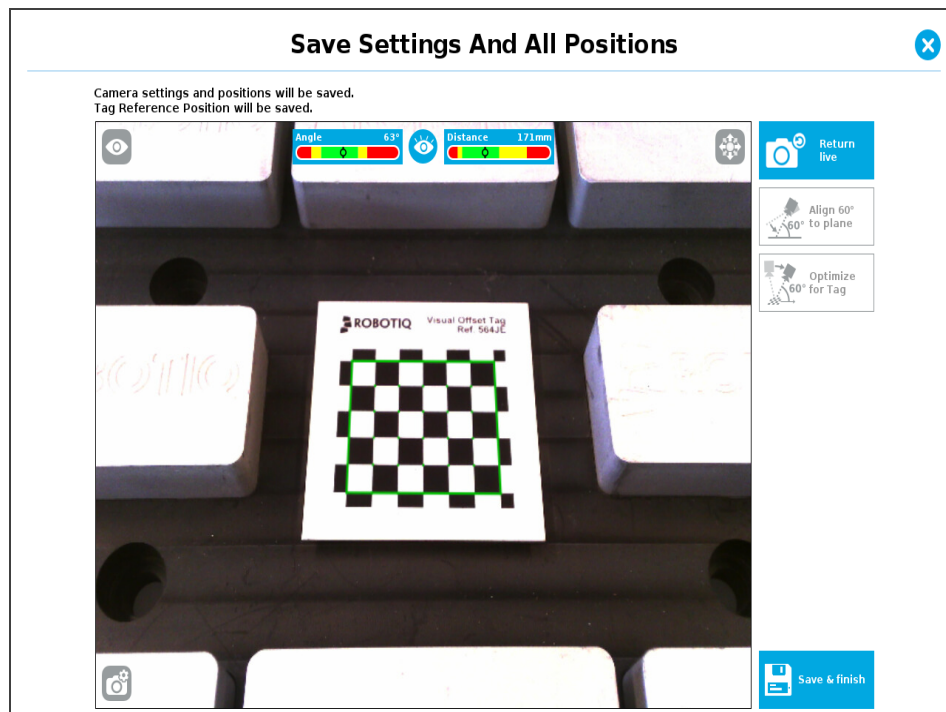

4.8.2. Tag set and edition

To edit or set the tag, go to **Installation** → **URCaps** → **Camera** → **Tags**.



Caution

Edit: allows you to change the camera position and settings. The Tag position will NOT be saved.

Caution

Set: it resets the Tag position if you want to make some touch-ups.



- Select the Tag to edit or to set and click on  or .
- You can either choose to **Go to Snapshot Position** or **Define new Snapshot position**.



Move Robot To Snapshot Position



The robot needs to go to the Snapshot Position.
Tap and hold the button to go to the Snapshot Position.

 The robot will move automatically.



For best performance, angles & distance from calibrated plane or Tag should be the same than those used when teaching the model or defining a Tag. Refer to user's manual for more information and options.

Speed  100%



- i. If you click on  button, the robot will move to the position before switching to the menu.



- ii. If you click on  button, it will directly switch to the menu.

4. To continue, follow the steps described in the **Define Far Camera position:** section **Define Close relative Camera position:** section.

Tip

Once you will have define the **Far position** and before setting the **Close position**, you will be asked if you want to



or



4.8.3. Change Tag Calibration

To change the calibration of an existing tag, go to **Installation**→ **URCaps**→ **Camera** → **Tags**.

1. Select the tag you want to modify and click on .
2. Select the Calibration to use to detect the tag.

Info

This makes it possible to transfer tags between robots.

The calibration used for the tag is indicated below the name of the tag.

4.8.4. Clone Tag

To clone an existing tag, go to **Installation**→ **URCaps** → **Camera** → **Tags**

1. Select the tag tag you want to clone and click on .
2. Enter the new name.

Info

This function is especially useful when you want to reuse the "Close Position" camera position and settings.

4.8.5. Using a Tag in a Robot program

Once a tag has been defined, you can start creating your robot program . The tag can serve as a reference point for moves in your program. Even if the tag moves (i.e. it is "offset"), the Wrist Camera can find its new location and quickly adjust your moves based on the value of the offset.

4.8.6. Find Visual Offset node

This node is used to calculate by how much a tag was moved, in reference to its value as calibrated previously. The value of the offset found by this Find Visual Offset node is temporarily saved, and you can reapply it in a Apply Visual Offset node. In the program, the condition "If tag found" is under the Find Visual Offset node. If no tag is found, no visual offset is applied to the robot program . If a tag is found, a visual offset is applied, and the robot moves to take a closer picture ("close_tag_pos"). A Find Visual Offset node is run again at a close distance (recommended distance is 15 cm max). Then, the value of the offset found at this step is used by an Apply Visual Offset node, which applies it to the "Call pick" routine.

Here is how to use the Find Visual Offset node.



Find Visual Offset



1. Select the Find Visual Offset node from the left navigation pane.
2. Tap **Select Tag** button.

Select Tag For Visual Offset



3. The "Select Tag For Visual Offset" window is displayed. Tap the tag you wish to use for your Find Visual Offset node.



Find Visual Offset



Feature to offset :
tag_close



To offset the feature using the result of this node, use the "Apply Visual Offset" node.

4. A tag is selected for the **Find Visual Offset** node.

4.8.7. Apply Visual Offset node

The Apply Visual Offset takes the value by which a tag has been offset, and modifies robot moves that are under this Apply Visual Offset node in the program. As a best practice, this node should be preceded by the condition "If tag found". Otherwise, if no tag is found with the Find Visual Offset node, the Apply Visual Offset may use a value found at a different time, which may not reflect the current offset value.

Here is how to use the Apply Visual Offset node:

Apply Visual Offset



1. Select the node **Apply Visual Offset** from the left navigation pane.

2. Tap



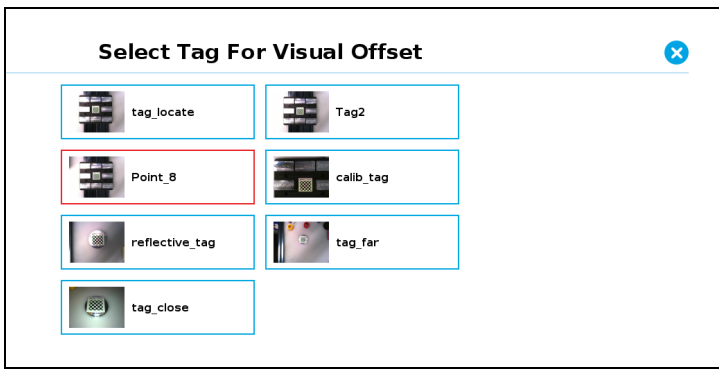

3. The "Select Tag For Visual Offset" window is displayed. Tap the tag you wish to use for your Apply Visual Offset node.

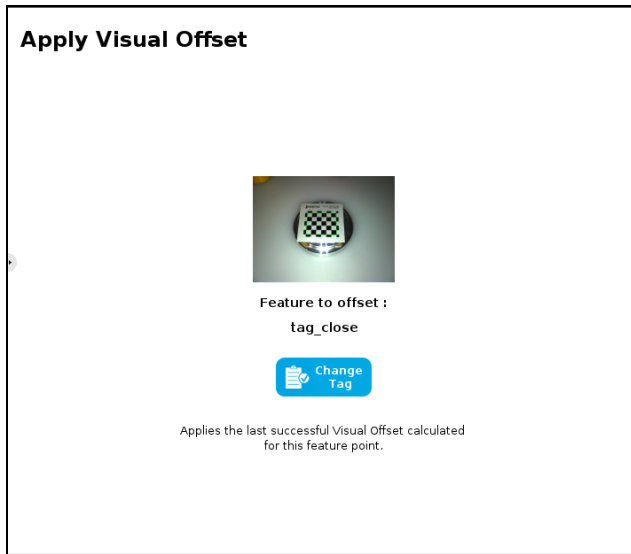

4. A Tag is selected for the Apply Visual Offset node.

After inserting this node into your robot program, create the rest of your program under the Apply Visual Offset node. All robot moves will be adjusted based on the value injected by this node.

4.9. Save Image node

You can take pictures with the Wrist Camera in the course of a robot program, and save them to a USB stick. This node is complementary to the Wrist Camera URCap nodes.

Since saving an image can take up to five seconds for high-definition images, this node might slow down your cycle time. We recommend using the Save Image node under "if_not_found" conditions. The picture taken can then be used either as an alternative means to collect data (e.g. for barcodes that could not be read or when no object is detected using a Cam Locate node), or as a quality assurance tool to document difficulties, and improve your process in the future. Those uses are suggestions. Use the Save Image node as it best suits your needs.



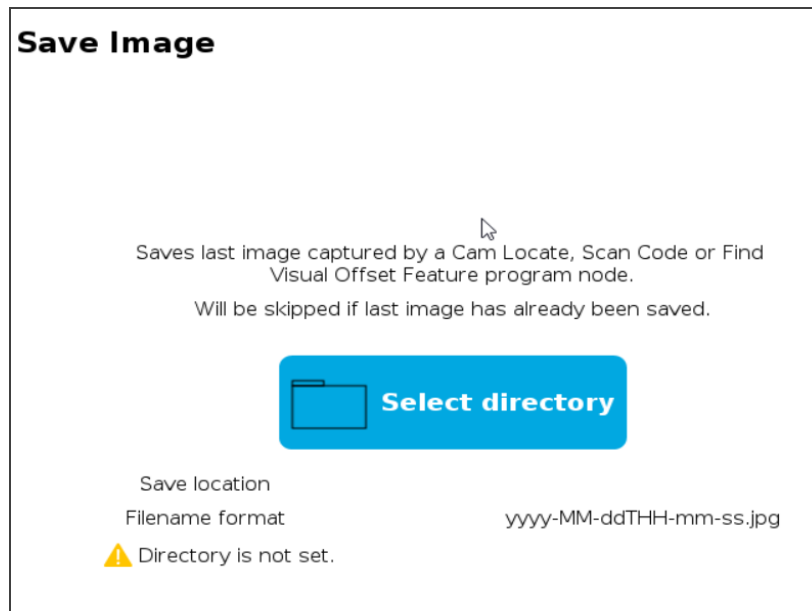

Fig. 4-83: The Save Image node.

- To save images to a USB stick, tap

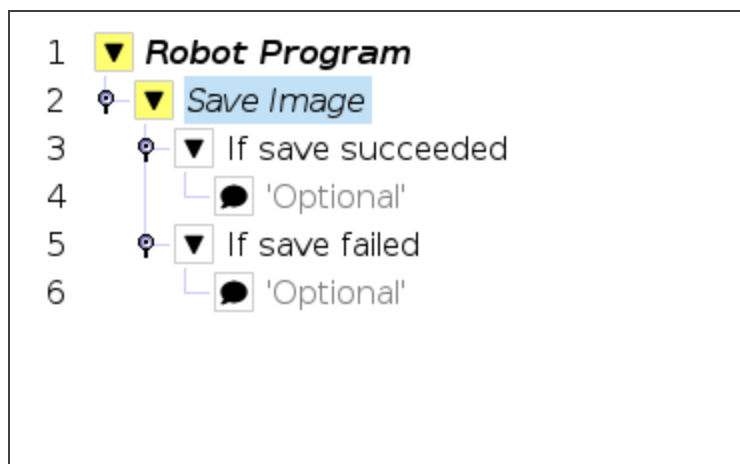

Fig. 4-84: The Save Image node in a robot program.

- You can add different instructions following the **Save Image** node, based on its success or failure. Before adding those instructions, you will need to select the directory where images are saved.
- Each image is saved in a separate .jpg file, and named as per this format: yyyy-MM-ddTHH-mm-ss.jpg.



5. Specifications

Info

This manual uses the metric system. Unless otherwise specified, **all dimensions are in millimeters.**

This section contains specifications for the RobotiqWrist Camera.

- **Mechanical Specifications** section
 - Dimensions
 - Maximum load
 - Center of mass
 - Moment of inertia
- **Electrical and Optical Specifications** section
 - Electrical supply
 - Resolution
 - FPS
- **Vision System Specifications** section
 - Field of view
 - Part size



5.1. Mechanical Specifications

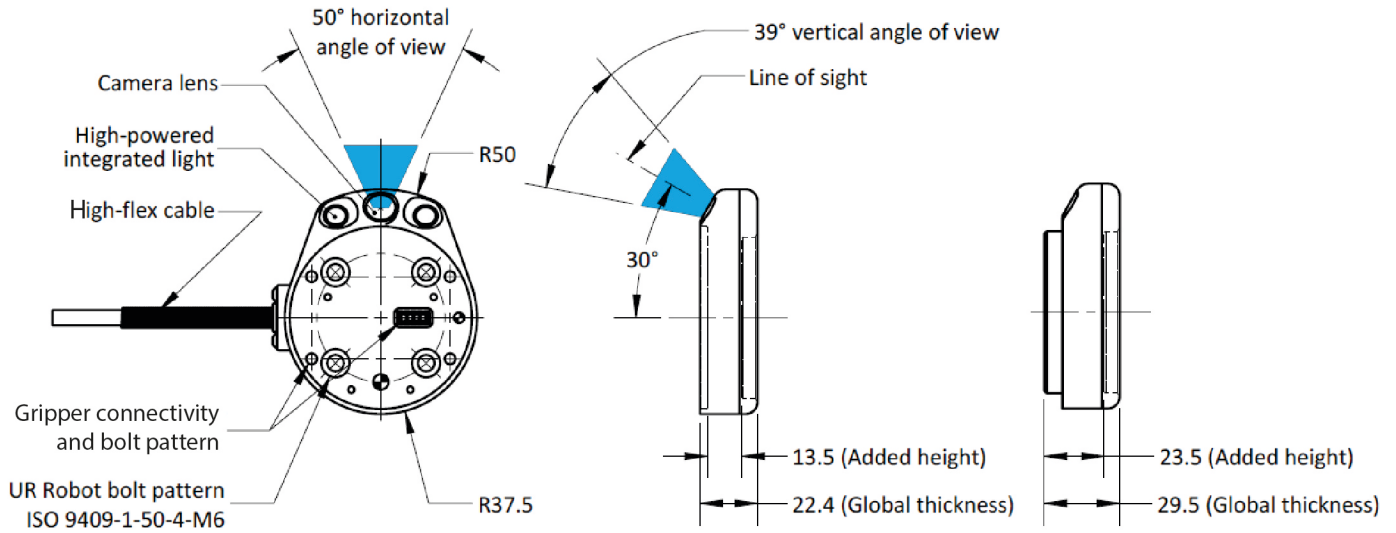

Fig. 5-1: Dimensions of the Wrist Camera.

Specifications	Value
Maximum load	10 kg / 40 Nm
Weight (no tool plate)	160 g
Weight (with tool plate)	230 g
Added height (no tool plate, with a 2-Finger Adaptive Gripper)	13.5 mm
Global thickness (no tool plate)	22.4 mm
Added height (with tool plate)	23.5 mm
Global thickness (with tool plate)	29.5 mm

Table 5-1: Mechanical Specifications of the Wrist Camera.



Info

The photographic sensor, in line with Universal Robots axes system, is located at [0mm, 35.7mm, 0.1mm] of the tool flange on which the Wrist Camera is mounted. The line of sight passes through this point at 30° from the Z-axis.

5.1.1. Center of Mass and Moment of Inertia

The coordinate system used to calculate the moment of inertia and center of mass of the Wrist Camera is the base of the Wrist Camera, which correspond to the Universal Robots tool flange reference [0,0,0].

Here is the approximate position for the center of mass.

Product	x (mm)	y (mm)	z (mm)	Mass (grams)
Wrist Camera	-6.5	6.6	4.0	195
Wrist Camera (with tool plate)	-4.3	4.0	8.5	245

Table 5-2: Center of mass and payload for the Robotiq Wrist Camera

Info

For TCP and center of mass of the Wrist Camera with gripper combinations, please consult the specific table provided on our [support website](#).

Inertia Matrix			Metric value (kg * mm ²)			Imperial value (lb * in ²)		
lxx	lxy	lxz	111	0	0	0.38	0	0
lyx	lyy	lyz	0	70	3	0	0.24	0.01
lzx	lzy	lzz	0	3	165	0	0.01	0.56

Table 5-3: Moment of inertia matrix for the Wrist Camera. Values are approximated.



5.2. Electrical and Optical Specifications

Robotiq recommends you supply power to the Wrist Camera from the Universal Robots controller, as shown in the Electrical Setup section below.

Specification	Value
Operating supply voltage	24 V DC ±20%
Quiescent power (minimum power consumption)	1 W
Maximum power	22 W
Communication interface	USB 2.0

Table 5-4: Wrist Camera electrical specifications.

Specification	Value
Maximum resolution	5 Mpx at 2 fps (2560 X 1920)
Maximum frame rate	30 fps at 0.3 Mpx (640 X 480)
Active array size	2592 X 1944
Focus range	70 mm to ∞
Integrated lighting	6 LED diffuse white light
Autofocus technology	Liquid lens

Table 5-5: Wrist Camera optical specifications.



5.3. Vision System Specifications

5.3.1. Accuracy

The accuracy of the vision system is as described in the table below and depends on the robot model used. It is valid for the area where the calibration board was located during the calibration process.

Robot Model	Accuracy
UR3	+/- 2mm
UR5/UR16	+/- 3mm
UR10	+/- 3mm

Fig. 5-2: Accuracy of the vision system.

5.3.2. Calibration Board Position

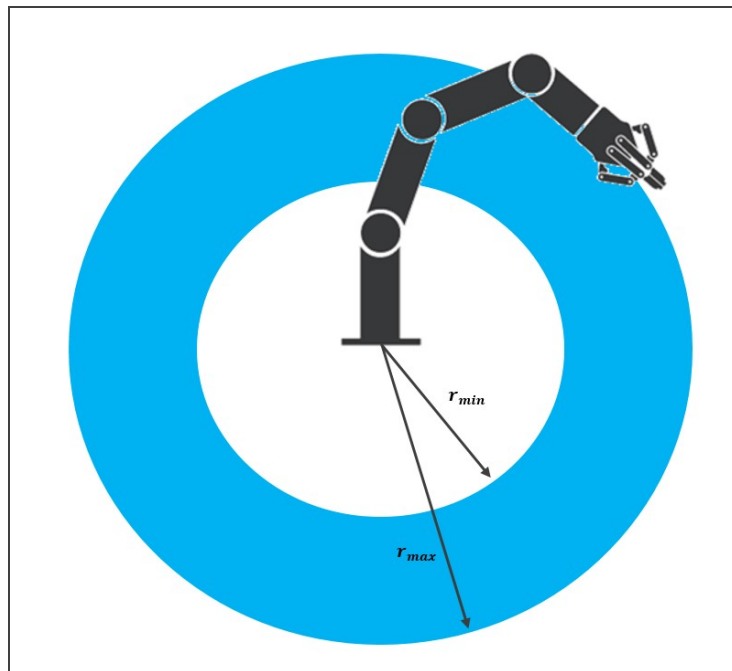

Fig. 5-3: Calibration board position.



Specifications	Value			
	UR3	UR5	UR10	UR16
Minimum board distance (cm)	26	34	42	34
Maximum board distance (cm)	42	70	98	70

Tips

The Snapshot position determines the field of view. Notice that the calibration position can differ from the Snapshot position. You can have a small field of view, then move back to get a wider field of view for calibrating.

5.3.3. Field of view

The field of view of the Wrist Camera varies based on the distance between the workplane and the Wrist Camera. The table below shows fields of view for some Universal Robots models.

	UR3		UR5 / UR16		UR10	
	Distance* (mm)	FoV (mm)	Distance* (mm)	FoV (mm)	Distance* (mm)	FoV (mm)
Maximum**	347	360 x 270	646	640 x 480	1030	1000 x 750
Minimum**	70	100 x 75	70	100 x 75	70	100x 75

Table 5-6: The field of view of the Wrist Camera varies based on robot reach.

*Workplane surface to camera distance (considering the workplace surface at the same level as the robot base).

**For indication only, larger field of view is possible depending on robot mounting configuration and parts locations. Contact Robotiq support if more information is required.

Info

Field of view is (FoV) determined by Snapshot position. To get the minimum FoV, the Wrist Camera must be 7 cm above its workplane.



5.3.4. Part dimensions

The maximum size that can be detected by the Wrist Camera is 60% of the field of view in both directions (60% horizontal and 60% vertical). The minimum is 10% in both directions no matter the robot or field of view size.

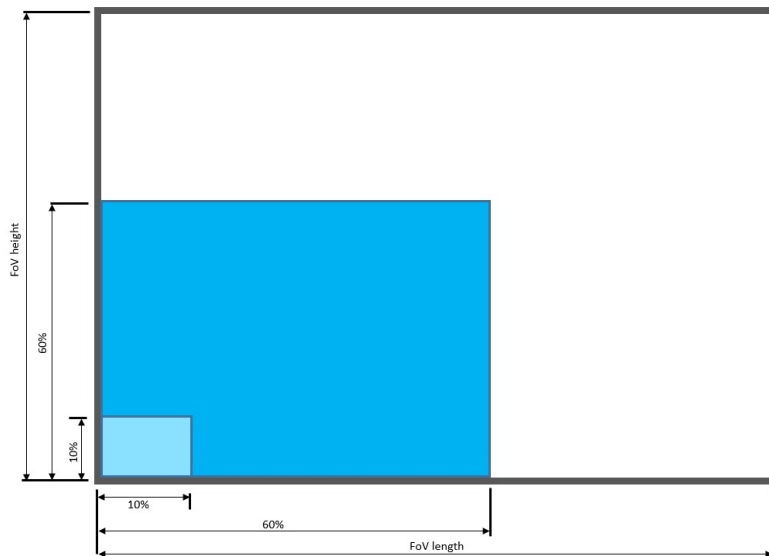

Fig. 5-4: Maximum and minimum part size.

Caution

The part must not be higher than its smallest dimension (width or length) : maximum of 1:1 ratio.

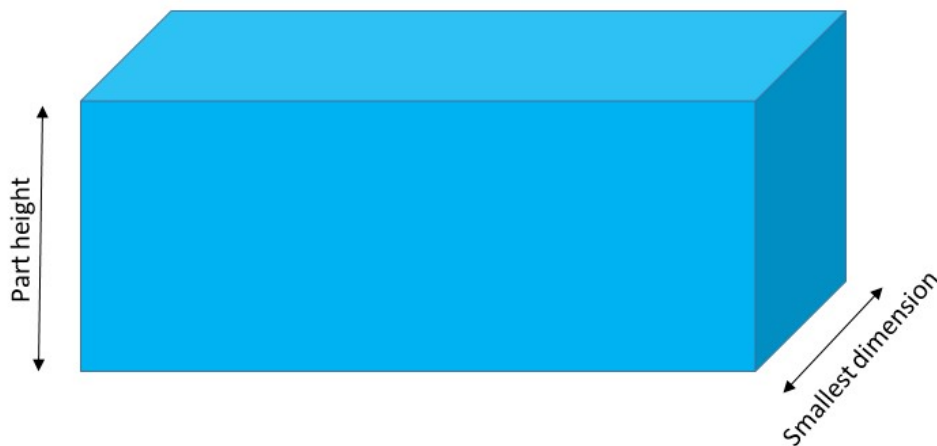

Fig. 5-5: Maximum part height.

Info

Part height ratio is taken between the maximum part height at any point and the minimum dimension present on part contour, width or length.



5.3.5. Background contrast

To ensure a good model and part detection from the Vision system, you should use a background that has a high color contrast with the part to be detected. You must choose colors that are apart horizontally on the HSV cone shown below. Therefore, a change in value (intensity) only does not represent a good contrast. There has to be a great difference in hue and saturation to obtain a good object model from the object teaching wizard. You can use either the yellow or pink side of the colored background provided with the camera kit. If required, use a different colored background to teach your part.



6. Maintenance

The Wrist Camera requires no maintenance. Make sure its lens remains free from liquid or dust. To clean the lens, apply alcohol and wipe it with the pouch that contained your Wrist Camera.

The work plane should remain unchanged through time. Depending on your application, you should occasionally clean the work plane more or less regularly.

Caution

If you change your work plane background after the teaching process, this could lead to a decrease in object detection.

Tip

The Vision System can compensate for some differences during runtime. Adjust the detection threshold as explained in the **Object Teaching** section to have a reliable object localization.



7. Spare Parts, Kits and Accessories

Caution

The following list is up-to-date at print time and is subject to change. Check online for updates.

Info

Unless specified, screws, dowel pins and other hardware are included only for the Sensor side, never for the robot side.

Info

For Spare Parts and kits before the new 5-m high flex cable of the Robotiq Wrist Camera, please consult the last version of the instructions manual available in the Archives section of our [support website](#).

Items	Ordering Number
Wrist Camera Kit for Universal Robots. Includes Wrist Camera, calibration board, tool plate for UR, USB memory stick, license and hub and all hardware.	RWC5-UR-KIT
Replacement Wrist Camera. Includes 5 m pigtail cable.	RWC5-CAM-001
Wrist Camera tool plate for ISO 9409-1-50-4M6 pattern (Universal Robots).	RWC-TOOL-062
Replacement calibration board.	ACC-CALIB-BOARD
Replacement 5m High-Flex pigtail cable for Wrist Camera.	CBL-COM-2075-05-HF
4-port USB 2.0 hub splitter	ACC-USB-4-HUB
Replacement software license USB dongle for Wrist Camera	ACC-USB-DONGLE
Universal Robots Screw Kit for Wrist Camera	ACC-SCREW-KIT-RWC-UR
Wrist Camera Tag for Visual Offset (5)	ACC-TAG-1BAG5



8. Troubleshooting

Info

For details on the Vision server, Camera URCap and Wrist Camera firmware versions, go to the **Installation tab > Camera > About**.

Versions are displayed. Check version numbers, and update all URCap to their latest release.

LED colors can provide information on the issue you are facing. Read the table below for more details.

LED status	Description	Solutions
Off	The Camera is not powered.	Check the Camera's power supply and electrical setup (please refer to the Electrical Setup section).
Solid red	No fault but the Camera is not communicating.	Start or do a stop/start cycle of the Vision server. To do so, go in the Installation tab, choose Camera and then the Camera tab. Click on Start camera to start the Vision server. The output image will appear and the LED will turn blue. Check the USB cable connection and the software package versions.
Solid blue and red at the same time	The Camera is in fault or booting.	Wait for the booting process to be completed. If the LED stays solid blue and red, disconnect the Camera's USB cable and power cycle it. The red LED should be solid red. Reconnect the USB cable. The LED should turn solid blue when communication is established with the Vision server (click on Start camera from the Installation tab).
Blinking blue and red	Major fault: <ul style="list-style-type: none">• Camera's input voltage is not sufficient• Temperature is greater than 70°C	<ul style="list-style-type: none">• Check the power supply to make sure it is 24 V DC +/- 10%.• The Wrist Camera should not operate at a temperature higher than 50°C.
Solid blue	Not fault and communicating.	/



9. Warranty and Patent

Robotiq warrants the Wrist Camera and Vision System against defects in material and workmanship for a period of one year from the date of reception when utilized as intended. Robotiq also warrants that this equipment will meet applicable specifications under normal use.

Warranty applies under the following conditions:

- Usage respects the operating and storage conditions specified in the Environmental and Operating Conditions section.
- Proper installation of the Wrist Camera specified in the Installation section and the following subsections.
- Usage under normal one-shift operation (40 h a week)
- Usage respects maintenance specified in the Maintenance section.
- Usage respects recommended payload and forces specified in the Mechanical Specifications of Wrist Camera section.

During the warranty period, Robotiq will repair or replace any defective Wrist Camera, as well as verify and adjust the Camera free of charge if the equipment should need to be repaired or if the original adjustment is erroneous. If the equipment is sent back for verification during the warranty period and found to meet all published specifications, Robotiq will charge standard verification fees.

The unit is considered defective when at least one of the following conditions occurs :

- The Camera does not output any image;
- The Camera feedback necessary for the robot program is not accessible;
- The Vision System USB memory, USB hub or USB dongle are inoperable;

Caution

The warranty will become null and void if the :

- Unit has been tampered with, repaired or worked on by unauthorized individuals.
- Warranty sticker has been removed.
- Screws, other than as explained in this guide, have been removed.
- Unit has been opened.
- Unit serial number has been altered, erased, or removed.
- Unit has been misused, neglected, or damaged by accident.



This warranty is in lieu of all other warranties expressed, implied, or statutory, including, but not limited to, the implied warranties of merchantability and fitness for a particular purpose. In no event shall Robotiq be liable for special, incidental, or consequential damages.

Robotiq shall not be liable for damages resulting from the use of the RobotiqWrist Camera or Robotiq Vision System, nor shall Robotiq be responsible for any failure in the performance of other items to which the Wrist Camera is connected or the operation of any system of which the Vision System may be a part.

Exclusions

This warranty excludes failure resulting from: improper use or installation, normal wear and tear, accident, abuse, neglect, fire, water, lightning or other acts of nature, causes external to the Wrist Camera, the Vision System or other factors beyond Robotiq's control. It also excludes all consumable parts, such as fingertips and their normal wear.

Robotiq reserves the right to make changes in the design or construction of any of its products at any time without incurring any obligation to make any changes whatsoever on units already purchased.



10. Declarations and Certificates

10.1. Original Declaration of Incorporation



EU Declaration of Conformity (Original)

We, the manufacturer:

Robotiq Inc.
966 Chemin Olivier, Suite 500
Lévis, Québec, Canada, G7A 2N1

hereby declares, under sole responsibility, that the product:

Wrist Camera
Serial numbers above Q-02581
(and accessories)

is in conformity with the relevant Union harmonisation legislation, namely complies with the following European Directives and harmonised standards:

- **2014/30/EU (EMC Directive)**
 - *EN 61000-6-2:2016*
 - *EN 61000-6-4:2007 + A1:2011*
- **2011/65/EU + 2015/863 (RoHS Directive)**
 - *EN 50581:2012*
- **2012/19/EU (WEEE Directive)**
 - *EN 50419:2005.*

The manufacturer also declares the use of these other technical standards, as far as applicable:

ISO 9409-1:2004.

Name and address of the person authorised to compile the relevant technical documentation:

Nicolas Tremblay, CEP, see manufacturer address.

The relevant technical documentation is compiled in accordance with Annex II of Directive 2014/30/EU and will be presented electronically by the manufacturer to competent national authorities, if required with a substantiated reason.

Signed in Lévis on March 1st, 2021

A handwritten signature in black ink, appearing to read 'Louis-Alexis Demers'.

Louis-Alexis Allen Demers, ing., Eng., Ph. D.
Hardware Director



10.2. Ingress Protection Certificate



October 12th 2018

Purpose: Ingress Protection (IP67) – Wrist Camera Test Certificate

To whom it may concern,

This certificate is to attest that Ingress Protection (IP) tests were carried out by NTS Canada in the months of June and July 2018 on Wrist Cameras manufactured by Robotiq. No ingress of dust or water was observed inside the units after the tests. No insertion of the rod or induced damage was observed. No functional anomaly was noticed or reported by the Robotiq engineering representative on-site during the tests. This test certificate does not supersede the test report FTR0201898 Rev 00 issued by NTS Canada.

The acceptance status for the units tested is "PASS" for the following tests:

- Ingress protection against access to hazardous parts – Rod (code IP6X)
- Ingress protection against solid foreign objects - Dust (code IP6X)
- Ingress protection against immersion in water (code IPX7)

Sincerely yours,

Jean-Pierre
Rioux

Digitally signed by Jean-Pierre
Rioux
DN: cn=Jean-Pierre Rioux, o,
ou=NTS Canada Inc.,
email=Jean-
Pierre.Rioux@NTS.com, c=CA
Date: 2018.10.12 11:32:13
-0400'

Jean-Pierre Rioux, P. Eng.
Lab Manager
National Technical Systems Canada inc.
2425 Industrial Blvd
Chambly, Quebec
J3L 4W3 Canada



11. Contact

www.robotiq.com

Contact Us

Phone

1-888-ROBOTIQ (762-6847)
(01) 418-380-2788 Outside US and Canada

Technical support and engineering

option 3

Sales

option 2

Head office

Robotiq:
966, chemin Olivier
Suite 500
St-Nicolas, Québec
G7A 2N1
Canada



Where automation Pros come to share their know-how and get answers.

dof.robotiq.com

